

LUMEL

DIGITAL PANEL METER

N320



SERVICE MANUAL



Contents

1 Application.....	3
2 Meter set.....	5
3 Basic requirements, operational safety.....	5
4 Installation.....	6
4.1 Installation method.....	6
4.2 External connection diagram.....	7
5 Service.....	10
5.1 Description of the frontal plate.....	10
5.2 Buttons' functions.....	12
5.3 Programming meter parameters.....	13
5.3.1 How to change quantity of a selected parameter.....	16
5.3.2 Programmable meter parameters, default parameters.....	16
5.4 Meter functions.....	23
5.4.1 Measurement.....	23
5.4.1.1 Fast changing pulses counter.....	26
5.4.1.2 Slow changing pulses counter.....	28
5.4.1.3 Period measurement.....	29
5.4.1.4 Frequency measurement.....	30
5.4.1.5 Rotation speed measurement.....	32
5.4.1.6 Encoder (only the main input).....	33
5.4.1.7 Pulse counter with pulse speed measurement (main input only).....	35
5.4.1.8 Working time measurement.....	38
5.4.1.9 Time measurement.....	39
5.4.1.10 Additional counters I3 and I4.....	39
5.4.1.11 Averaging the measuring quantities.....	39
5.4.1.12 Minimum and maximum measuring values.....	40
5.4.1.13 Mathematical functions.....	40
5.4.1.14 Individual characteristic.....	41
5.4.2 Analog output.....	42
5.4.3 Alarm outputs.....	43
5.5 RS-485 interface.....	45
5.5.1 Connection.....	45
5.5.2 Description of the MODBUS protocol implementation.....	46
5.5.3 Implemented functions of MODBUS protocol.....	46
5.5.4 Map of the registers.....	47
5.5.4.1 Registers 4000 – 4079.....	47
5.5.4.2 Registers 4200 – 4257.....	54
5.5.4.3 Registers 7500 – 7521 and 7000 – 7043.....	56
5.5.4.4 Registers 7600 – 7744 and 7200 – 7489.....	57
6 Error codes.....	62
7 Technical data.....	63
8 Ordering code.....	67

1 Application

The N32O meter is a digital panel meter adapted to be fixed to the panel. The N32O meters are designed to measure the number of pulses, period, frequency, rotational speed, number of pulses and their frequency, working time, position (support for an incremental encoder) or any other value that is a derivative of the mentioned parameters. The N32O meters, thanks to many configuration options, can be used as the media consumption counters with an indication of a real-time consumption dynamics. Two measuring channels allow to save an installation space and the costs of the measuring equipment. The universal inputs with filter functions support the majority of available sensors with NPN and PNP outputs.

Additionally, the meter supports the programmable alarms with the delay activation and deactivation function as well as a memory of the alarm event. The functionality of the meter is complemented by a programmable analog output - RS-485 interface.

The user interface consists four buttons and the high contrast LCD display with backlight. Thanks to the two-line display, it is possible to set the selected unit, display simultaneously two measuring values, the measuring value and the current time, as well as a clear and user friendly menu with simultaneously visible the parameter name and its value.

Features of the N32 meter:

- Wide range of configuration options for measuring pulse signals.
- Possibility of simultaneous measurement in two channels.
- Additional inputs controlling the counters with the possibility to configure their operation. The additional inputs can also be used as the counters which can be accessed via the RS-485 interface.
- Compatible with NPN or PNP sensors.
- Additional supply output +24 V to supply the sensors.
- Integrated configurable signal filtering functions which can be disabled. For example, it is possible, thanks to the filters, to configure the counter to count the number of elements with holes that may interfere the counting process (possibility of multiple counting for a single element).
- High sampling frequency of the measuring signals.
- Incremental encoder support.
- Dedicated settings for counting slowly changing pulses with the elimination of interferences, e.g. the pulses from various types of contacts, buttons, switches, etc.

-
- Integrated mathematical functions - individual for each channel.
 - Two individual characteristics enabling the conversion of the main measuring value in a given channel according to the programmed characteristic.
 - High contrast LCD display with built-in backlight.
 - Two-line display.
 - Possibility to select the unit of the measuring (displayed) value.
 - Possibility to simultaneously display two selected measuring quantities or a measuring quantity and e.g. a unit or time.
 - Programmable displayed precision with automatic setting of a decimal point.
 - Possibility to program the measuring range (narrowing) for the selected displayed value.
 - Additional measurement of minimum and maximum values during the moving window, with the possibility of programming one of these values to be displayed as the main one.
 - Programmable alarms with the functions of programmable delays of alarm activation and deactivation, triggered by a specific controlling value. Up to 4 relays, including up to 3 relays with a switching contact. Possibility to configure each of the alarms to work in a selected mode and to react to any measuring quantity including the current time.
 - Possibility to control the alarm outputs (relay) via the RS-485 interface.
 - Programmable standard analog outputs enabling the retransmission of a selected measuring quantity or a selected parameter. Freely programmable output type and conversion range.
 - Built-in by default RS-485 interface with MODBUS RTU protocol support.
 - Built-in real-time clock with a built-in automatic change of DST and inversely. The clock can be a parameter which controls the alarms and the value of the analog output signal.
 - Possibility to password protect the settings against unauthorized modification.
 - Monitoring of set parameters.
 - averaging algorithm in a specified time using standard averaging (determining the number of measurements to be averaged) and averaging based on the moving window algorithm with a given averaging time.
 - Signaling of alarm operation by highlighting the number of the active alarm.

- Registration of minimum and maximum measuring values.
- Galvanic separation of the connections: alarm, measurement, analog outputs, auxiliary supply outputs, RS-485 interface and supplying input.
- Protection degree from the front IP65.
- Meter overall dimensions 96 x 48 x 100 (with the terminals).
- The casing is made of a self-extinguishing plastics.
- Wide range of supply voltages.

The view of the N320 meter is shown in Fig. 1.



Fig. 1: View of the N320 meter.

2 Meter set

The meter set includes:

- Meter N320 – 1 pc
- User's manual – 1 pc
- Clamps to fix in the panel – 4 pcs
- Seal – 1 pc

3 Basic requirements, operational safety

In terms of a user safety, the N320 meter meets the requirements of the EN61010-1 standard for the devices intended for use in facilities compliant with the third category of installations.

Comments concerning safety



- Assembly and installation of the electrical connections should be conducted only by a person authorised and certificated to perform assembly of electric devices.

- Always check the connections before turning the meter on.
- The meter is designed to installation and usage in the industrial electromagnetic environment.
- A switch or a circuit-breaker should be installed in the building or facility. The switch should be located near the device, easily accessible by the operator and suitably marked.
- Removal of the meter electronics during the warranty period voids the warranty.

4 Installation

4.1 Installation method

The N320 meters are designed to be mounted in a panel. Prior to installation a $92^{+0.6} \times 45^{+0.6}$ mm slot must be made in the panel. The maximum thickness of the panel material cannot exceed 6 mm. The meter should be mounted from the front of the panel with disconnected meter connection strips.

Before inserting the meter into the panel check the correct position of the meter seal and make sure that the edges of the panel are not sharp what could damage the seal. After inserting the meter into the slot, mount it with the mounting brackets provided in the meter set (Fig. 2).

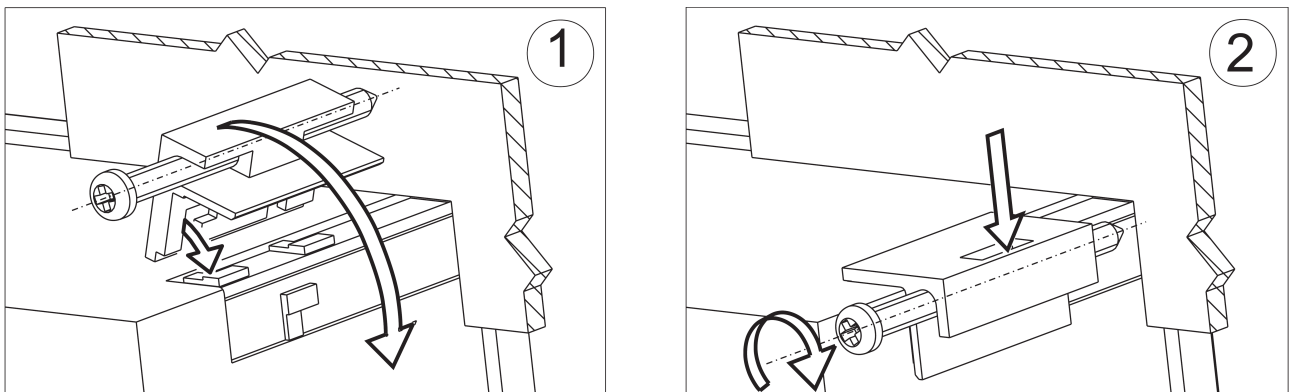

Fig. 2: Meter fixing.

Electrical connections of the meter should be made with the wires with the cross-section up to 2.5 mm^2 and 1.5 mm^2 for the input circuits. Detachable sockets with the plugs of 5.08 mm pitch can be used for the connections and 3.81 mm for the input circuits.

The external dimensions of the meter are shown in Fig. 3.

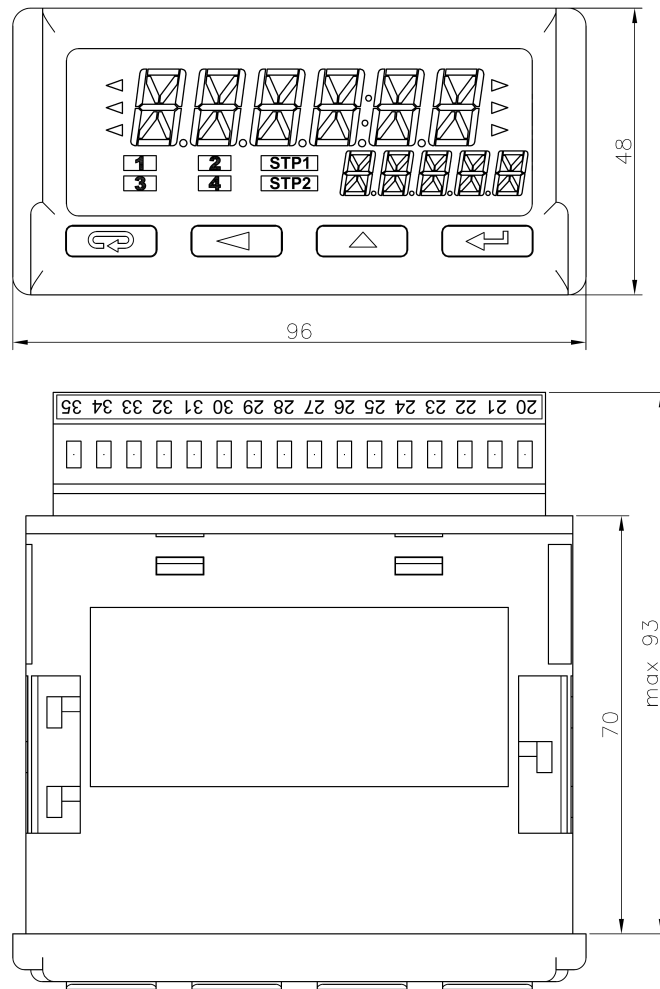

Fig. 3: Meter overall dimensions.

4.2 External connection diagram

The N320 meter has three detachable terminal strips to connect the wires of a cross-section up to 2.5 mm² and 1.5 mm² for the input circuits. The view of the meter from the connectors' side is shown in Fig. 5. The upper terminal strip is optional and depends on the accessories of the meter.

The circuits of successive groups of the terminals are separated from each other, as shown in Fig. 4.

Supply	Alarm 1	Alarm 2	Measuring input	
Output 24 V DC	Alarm 3	Alarm 4	RS-485	Binary output

Fig. 4: Galvanic isolation of the N320 meter.

Note: Unused terminals of the terminal strips (NC) must not be connected to any signals.

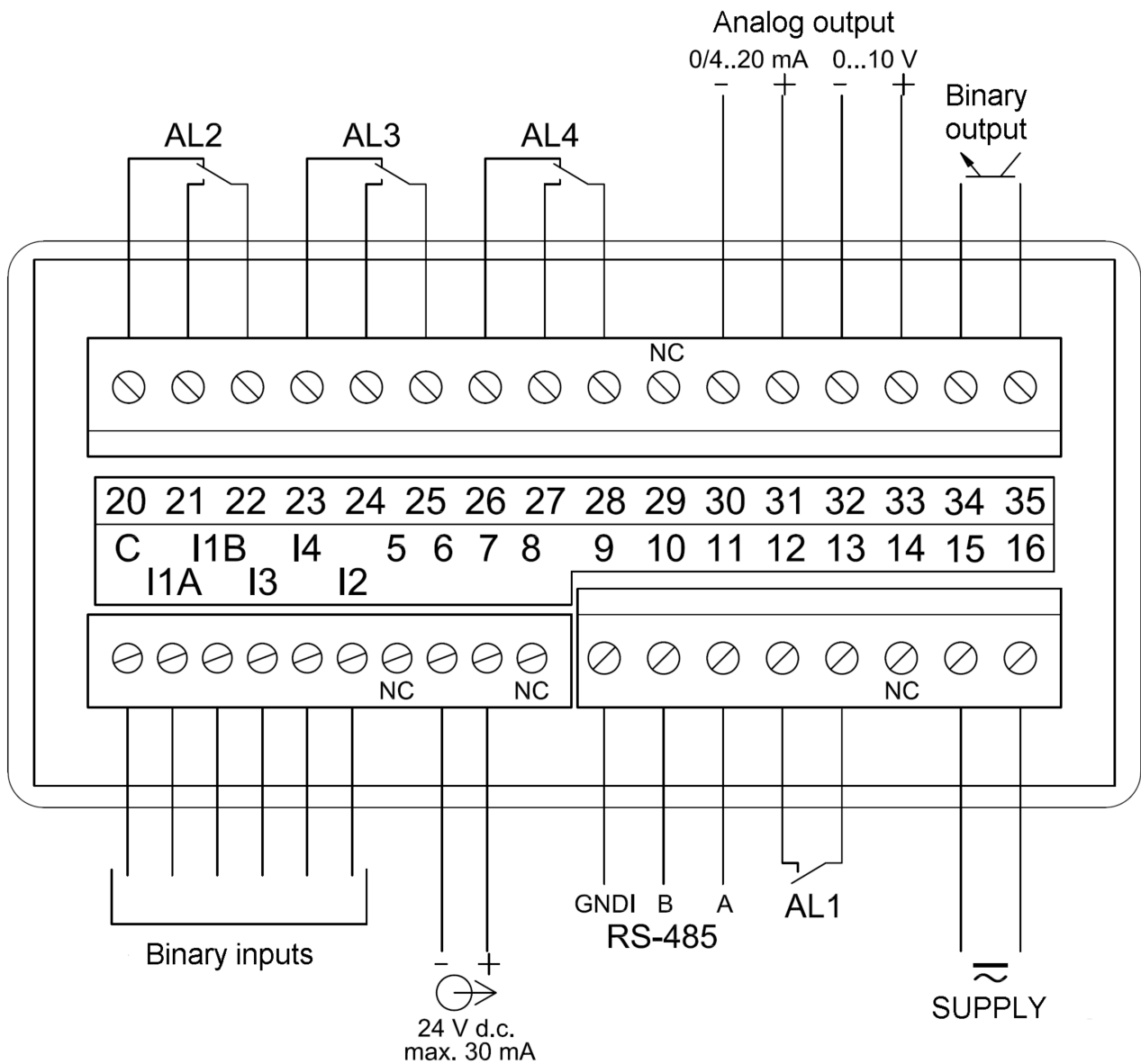

Fig. 5: Signals on the terminal strips.

Detailed description of the signals is shown in the table below, and the connection of the measuring signals is shown in Fig. 6.

Terminal	Function	Description
C, 1A, 1B, I2, I3, I4	Binary (Measuring) inputs	<p>Binary (Measuring) inputs for connecting the measuring signals:</p> <ul style="list-style-type: none"> C – common terminal of measuring signals. The terminal should be connected to the power supply ground in the systems with PNP sensors. In the systems with NPN sensors, the terminal should be connected to the sensors supply terminal. I1A and I1B – main measuring input. I2 – additional measuring input. I3, I4 – control inputs - inputs functions are

		programmed. Examples of the connections are shown in Fig. 6.
9, 10, 11	RS-485	RS-485 interface signals
12, 13	Alarm 1	Alarm output 1, which is NO relay contact.
15, 16	Power supply	Meter power supply connection. Range of supply voltages supported by the meter depends on the ordering code. It is required to check if the rated range of the meter corresponds to the installation to which the meter will be connected before installing the meter.
20...28	Alarms 2, 3, 4 (optional)	The alarm outputs 2, 3 and 4 use a relay with a switching contact.
30...34	Analog output	Analog output. The output must be properly connected according to the type of output selected in the configuration (voltage or current): the terminals 30 and 31 for the current output or the terminals 32 and 33 for the voltage output. It is not possible to use the voltage and current outputs at the same time - the correct value in accordance with the configuration, will be available only for the selected output type.
35, 36	Binary output	Open collector binary output for future applications. The output should be left unconnected.
8, 14, 29	NC	Unused terminals. Should be left unconnected.

The example of input signal connections to connect the sensors with PNP output (Fig. 6a) and NPN output (Fig. 6b) is shown below.

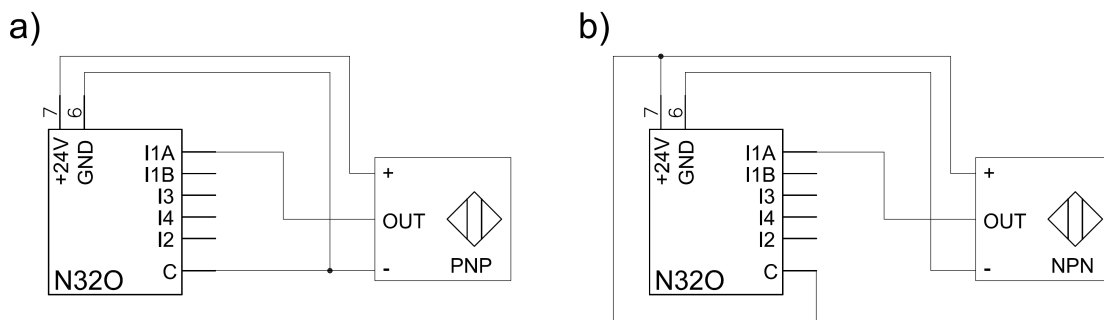

Fig. 6: Connection of the N32O meter.

In the example shown above, the sensor is supplied from the auxiliary power supply output. Fig. 7 below shows an example of connecting an incremental encoder with PNP outputs supplied from the auxiliary power supply output (Fig. 7a) and a system where the encoder is supplied from an external power supply (Fig. 7b). In the second circuit, an additional connected button is used to reset the pulse counter (position).

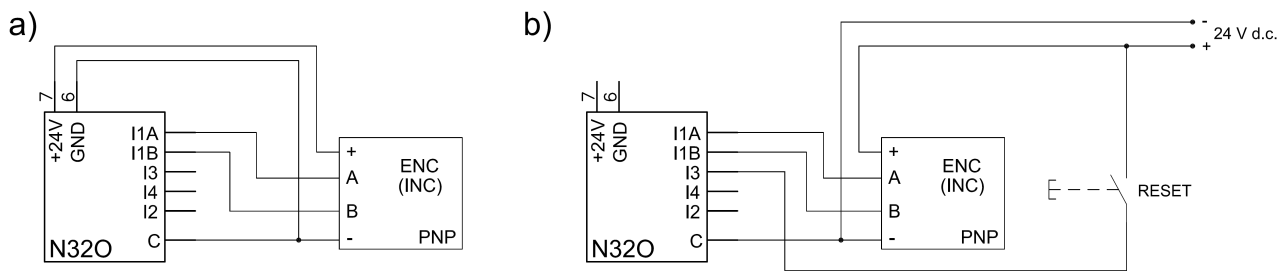

Fig. 7: Example of connecting an incremental encoder with PNP outputs.

5 Service

The N32 meter user interface includes an LCD display and the buttons which enable to display the measuring value, a full configuration and setting of the meter or modification of the parameters.

After turning the meter on the display shows the name of the meter and the software version. If there is no error during meter initialization process, the meter will switch to displaying the measuring value. If during the initialization any irregularities or deviations are detected, than a message with information about a detected error will be displayed (see point 6 - Error codes).

5.1 Description of the frontal plate

View of the front panel of the meter is shown in Fig. 8. The LCD display with backlight and 4 buttons are on the front panel. The description of the display fields is shown below. The button functions are shown in the section 5.2.

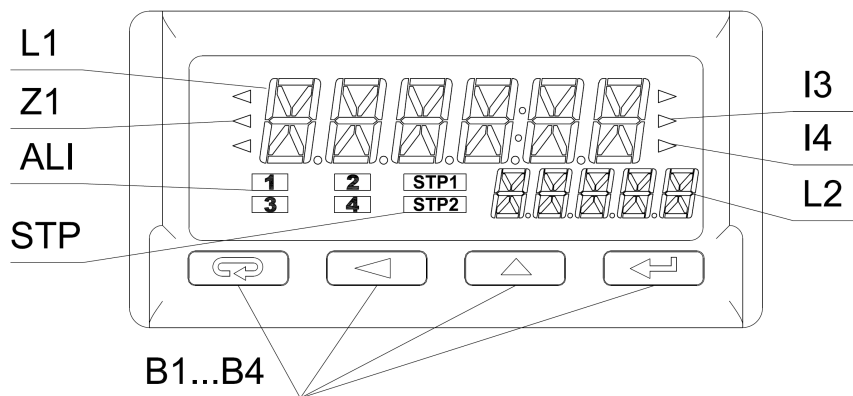

Fig. 8: Front panel of the meter.

Designation	Description
L1	The upper (main) line of the display has 6 characters used to display a measuring value or a parameter value during the meter configuration.
L2	The lower (auxiliary) line of the display has 5 characters used to display a measuring value, not converted by the individual characteristic or,







	according to configuration, a unit or current time.
Z1	Measuring value averaging indicator. Illuminated averaging indicator informs that the set measuring value averaging period has not elapsed yet.
I3	State of auxiliary input I3.
I4	State of auxiliary input I4.
ALI	Alarm status field. This field contains the indicator informing about the alarm status. Illuminated alarm indicator means that an alarm event is in progress and the relay corresponding to the alarm is activated. Flashing symbol means that the alarm state is saved (if the alarm memory is activated).
STP	Stop counting indicator lamps (counter STOP from the input 1 or the input 2).
B1...B4	Meter operation buttons. The description of the button functions and their various combinations are shown in section 5.2.





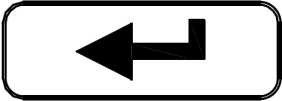





The lower line of the display can be configured to display the unit or a selected measuring value (including time). The available units and the corresponding MODBUS register 4025 values are shown in the table below.

Value in the register 4007 (setting)	Unit	Value in the register 4007 (setting)	Unit	Value in the register 4007 (setting)	Unit
0	-----	20	kvarh	40	h
1	mV	21	Mvarh	41	m ³
2	V	22	VAh	42	rpm
3	kV	23	kVAh	43	pcs
4	mA	24	MVAh	44	pulses
5	A	25	Hz	45	rps
6	kA	26	kHz	46	m/s
7	W	27	Ω	47	l/s
8	kW	28	kΩ	48	rpm
9	MW	29	°C	49	m/min
10	var	30	°F	50	l/min
11	kvar	31	K	51	pcs/h
12	Mvar	32	%	52	m/h
13	VA	33	%rh	53	km/h
14	kVA	34	pH	54	m ³ /h
15	MVA	35	kg	55	kg/h
16	Wh	36	bar	56	l/h

17	kWh	37	m		
18	MWh	38	l		
19	varh	39	s		

5.2 Buttons' functions

	<p>Cancel button:</p> <ul style="list-style-type: none"> • Exiting the menu and exit to the main screen. • Exiting a lower level of the menu and return to a higher level. • Canceling changing the set value (when editing the parameter value)
	<p>Digit change button:</p> <ul style="list-style-type: none"> • Navigating the menu - decreasing the items of the menu. • Decreasing the controlled quantity while editing a parameter and setting selection from the list of settings, e.g. alarm type. • Changing the controlled digit when setting numerical parameters. • Pressing the button during a normal operation displays a minimum value for 2 seconds, then the display returns to displaying a measuring value.
	<p>Increase value button:</p> <ul style="list-style-type: none"> • Navigating the menu - increasing the items of the menu. • Increasing the value of the selected parameter or increasing the value of a digit when changing the numerical value. • Pressing the button during a normal operation displays a maximum value for 2 seconds, then the display returns to displaying a measuring value.
	<p>Confirm button:</p> <ul style="list-style-type: none"> • Entering the programming mode (holding down the button for at least 3 seconds). • Navigating the menu - entering the parameter value editing mode or entering the selected lower level of the menu. • Accepting the changed parameter value. • Viewing the measuring values in the preview mode.
	<p>Deleting minimum value. DELMIN message is displayed after deleting. To avoid accidentally exit the menu in the preview mode, it is recommended to press first the button , and then the button  and holding them until DELMIN message is displayed.</p>
	<p>Deleting maximum value. DELMAX message is displayed after deleting. To avoid accidentally exit the menu in the preview mode, it is recommended to</p>

	press first the button  , and then the button  and holding them until DELMIN message is displayed.
 	Deleting alarm memory - hold down the buttons for 3 seconds. ClrAL message will be displayed after deleting alarm memory.
 	STOP – Pressing the buttons combination will stop the active counters, provided that the permission to control the counter using the meter buttons is enabled in the input configuration (bCtrl setting). The buttons operation applies only to the inputs working in the counter mode.
 	START – Pressing the buttons combination will start the counters, provided that the permission to control the counter using the meter buttons is enabled in the input configuration (bCtrl setting). The buttons operation applies only to the inputs working in the counter mode.
 	RESET – Pressing the buttons combination will reset (set) the counters, provided that the permission to control the counter using the meter buttons is enabled in the input configuration (bCtrl setting). The buttons operation applies only to the inputs working in the counter mode.

All the events of deleting of saved minimum, maximum values and alarm activation memory are indicated by the meter by displaying an appropriate message.

5.3 Programming meter parameters

Programming meter parameters is possible via the RS485 interface and by direct edition of the parameters using the buttons and the meter display.

Direct programming process is easy thanks to meter menu, which includes the settings grouped into sections with all parameters related to a given functionality, e.g. all parameters of the serial interface are grouped in the menu **RS485**.

Pressing and holding the confirm button for at least 3 seconds allows to switch from a normal operation to meter menu . If access to change the parameters is password protected, the user will be requested to enter the access password before entering the menu. Entering an incorrect password will allow to enter the menu but it will be not possible to change the parameters - parameters monitoring mode. Entering a correct password will allow to move to a programming matrix, the menu after entering the programming mode is shown below.

















Fig. 9: View of meter menu.

While navigating the meter main menu with the groups of the parameters, the upper line of the display shows the name of the group and the lower line continuously displays the word MENU. After entering the group of the parameters (after pressing the confirm button), the upper line displays the value of a given setting and the lower line shows the name of the parameter which value is displayed in the upper line. Sample view of the selection of the measured input signal type is shown in Fig. 9.







Fig. 10: View of menu when setting a parameter.



The buttons   allow to navigate the menu of the meter. After selecting the group of the parameters which configuration is to be changed, press the confirm button to move to the parameters of the group. The parameter which value is to be modified is selected the same way as the selection of the group. To cancel the parameter change, press the cancel button  to exit the parameter changing mode or the parameter group. The meter will automatically exit the programming mode and return to displaying the measuring value if no button is pressed for 30 seconds during programming. The programming matrix is shown below.

	 Selection of measuring quantities - input type.	 Selection of a rescaling by constant method.	 Constant rescaling the measuring value - pulsing number per a single count (revolution).	 The value to or from which is a counting (for counting down).	 Filter - minimum duration of the low level on the input.
	 Filter - minimum duration of the high level on the input.	 Permission to use the meter buttons to operate the counter (Start, Stop, Reset).	 Standard averaging - time of a single measurement as a multiple of 100 ms.	 Moving window method averaging - number of the measurements to be averaged (window width).	 Mathematical function selection based on which the measuring value should be converted.
	 The parameter available only for INP 1. Converter of the additional measuring value (frequency) during the measurement in the CntFL mode - time period selection.				





INP EX	IN3 F The function of the additional input no. 3.	EL3 Filter - minimum duration of the low level on the input no. 3.	EH3 Filter - minimum duration of the high level on the input no. 3.	IN4 F The function of the additional input no. 4.	EL4 Filter - minimum duration of the low level on the input no. 4.
	EH4 Filter - minimum duration of the high level on the input no. 4.				
INDCH1 INDCH2	INDCH Enabling or disabling the individual characteristic.	P CNB Number of points of the individual characteristic.	X01 Measuring value - point no.1.	901 Expected value for the measuring value X1.	X02 Measuring value - point no.2.
	902 Expected value for the measuring value X2.	X32 Measuring value - point no.32.	932 Expected value for the measuring value X32.
DISPL	DVAL Selection of main displayed value.	EA Lo Minimum value on the display. For values lower than this value, a lower overrun message is displayed.	EA HI Maximum value on the display. For values higher than this value, an upper overrun message is displayed.	RES Resolution - position of the decimal point.	UNIT Unit that can be displayed in the bottom line (when displaying the measured value).
	2L LINE Function of a lower line of the display - selection of a quantity displayed in the lower line.				
ALARM1 ALARM2 ALARM3 ALARM4	INPV Selection of quantity controlling the alarm state.	ATYPE Selection of alarm type.	P L Alarm state change lower threshold.	P H Alarm state change upper threshold.	DEL D Alarm activation delay.
	DEL OF Alarm deactivation delay.	MEM Active alarm memory.			
R5485	Addr Meter network address.	Mode Transmission frame type - data format.	BAUD Baud rate.		
ANOUT	ATYPE Selection of the type of analog output used.	INPV Selection of value controlling the analog output.	AN Lo Value of the controlling quantity for which the output will have a minimum value, in accordance with the selected output type.	AN HI Value of the controlling quantity for which the output will have a rated value, in accordance with the selected output type.	ANMAN Value on the analog output in case of manual control or an error on the measuring input.
SYSTEM	TIME Current time according to the internal clock.	DATE Current date according to the internal clock.	Auto Automatic change of DST and inversely	PASS Password to protect against settings modification.	FACT Restore default settings

5.3.1 How to change quantity of a selected parameter

To increase the value of the selected parameter, press the button . Pressing the button will increase the currently set digit by 1 and after reaching the value 9, pressing the button will set the value 0. After setting the required value of a digit, move to the next digit by pressing the button . After setting the required parameter value, press the confirm button  to accept the entered value or the cancel button  to cancel the parameter change and return to the previous value of the parameter. It is possible to change a sign of the entered value during setting the last digit (most significant).

There are three steps to change the floating point values. The first step is to set the digits and a sign in accordance with the algorithm described above. The second step is set the position of the decimal point after pressing the confirm button. The buttons   are used to set the position of the decimal point. After setting the decimal point position as required, press the confirm button to move to the third step - setting the multiplier of kilo, mega or no multiplier. Symbol of the multiplier value is shown on the left side of the display.



Entering an incorrect value of a given parameter causes that the new value is not accepted and the parameter will automatically have the previous value.







To change the parameters other than numerical select the appropriate setting from the parameter list using the buttons  . After selecting the appropriate setting, press the confirm button  to use the setting or the cancel button  to return to the previous value and exit the parameter change mode.

5.3.2 Programmable meter parameters, default parameters

The N320 meters have a number of programmable parameters, which enable the meter to be adapted to the requirements of application. The parameters grouped according to the menu are shown in the tables below.

Table 1

 - main input configuration (terminals I1A and I1B)		
 - additional input configuration (terminal I2)		
Parameter symbol	Description	Range of changes
	Input mode selection - selection of the measuring quantity	Default: Cnt SL CntF – Bidirectional fast pulses counter. Filter time settings in microseconds. Cnt SL – Bidirectional slow pulses counter. Filter time

		<p>settings in milliseconds.</p> <p>PERIOD – Period measurement. Additional frequency measurement.</p> <p>FREQ – Frequency measurement. Additional period measurement.</p> <p>tACHO – Rotation speed measurement. Additional frequency measurement.</p> <p>ENC* – Counter working with the encoder.</p> <p>CntFL* – Pulse counter with frequency measurement. The mode dedicated for the meters, it is possible to determine the flow rate in addition to counting. For example, the meter works with a flow meter, counts the pulses from the flow meter and converts the flow rate.</p> <p>W tIME – Bidirectional working time counter.</p> <p>tIMER – Bidirectional timer expressed in seconds with a resolution of 1 millisecond.</p> <p>tIME* – Real-time clock</p> <p>* - only available for the first channel INP 1</p>
	<p>Selection of the basic method of measuring quantity conversion. Multiplication or division by the value defined by CONST parameter.</p>	<p>Default: DIV</p> <p>DIV – division by a constant.</p> <p>MUL – multiplication by a constant.</p>
	<p>Constant rescaling the measuring value. The measuring value is multiplied or divided by this value depending on SCAL setting. Entering a negative value in the counter modes causes the counter to count down.</p>	<p>Default: 1</p> <p>-99999...999999</p>
	<p>For counting up, the setting value determines the value up to which the counter will be counting. The counter is automatically reset and counting starts from zero after reaching this value.</p> <p>For counting down, the setting value determines the initial value of the counter after a reset. During counting down, the counter will automatically return to the value set in CAUTO when the counter reaches the value 0.</p> <p>The value determines the encoder counter range for the encoder mode. The encoder counts to CAUTO value and then resets for the clockwise direction of the encoder rotation. The counter counts down to 0 and then sets CAUTO value for the counterclockwise direction of the encoder rotation.</p>	<p>Default: 999999</p> <p>-99999...999999</p>
	<p>Minimum duration of a low level on meter input before it is considered as the low level. Pulses with a shorter low level duration are ignored. The value is expressed in microseconds for CntF mode. And the setting is expressed in milliseconds for CNT SL mode.</p>	<p>Default: 0</p> <p>0...60000</p> <p>Note: Entering a duration time below 50 ms disables the low level filtering function.</p>
	<p>Minimum duration of a high level on meter input before it is considered as the high level. Pulses with a shorter low level duration are ignored. The value is expressed in microseconds for CntF mode. And the setting is expressed in milliseconds for CNT SL mode.</p>	<p>Default: 0</p> <p>0...60000</p> <p>Note: Entering a duration time below 50 ms disables the high level filtering function.</p>
	<p>Permission to control the counter using the meter buttons.</p>	<p>Default: ON</p> <p>ON – Control enabled. The following actions can be performed using the meter buttons: Start, Stop and Reset of the counter.</p> <p>OFF – Control disabled.</p> <p>Note: The setting only applies to the inputs set as the counter input.</p>
	<p>Measurement time. The setting determines the period of measurement (gating) during the frequency or period measurements. It also determines the maximum duration time of the</p>	<p>Default: 10</p> <p>1...600 – The value is expressed as a multiple of 100 ms. For example, the setting 10 sets the measurement time to 1</p>







	<p>measurement and limits the measurement of low frequencies. The period of the measuring signal must be shorter than the measurement time.</p> <p>The setting defines for the counter type inputs only data acquisition period for the averaging algorithm using the moving window method.</p>	<p>second and limits the frequency (period) measurement to the waveforms higher than 1 Hz.</p>
	<p>Number of the item for moving window method averaging. Each item is a measurement taken in SAVG time.</p> <p>Note: The averaging using the moving window method is disabled for the counter types. However, the minimum and maximum value in the time period set by MAVG setting is saved.</p>	<p>Default: OFF</p>
	<p>Mathematical function selection which should be applied for the measuring value. The mathematical function is applied before the value is converted by the individual characteristic.</p> <p>Note: The setting has no effect in <i>WtIME</i> and <i>tIME</i> modes.</p>	<p>Default: NONE</p> <p>NONE – no additional mathematical operations. Sqr – measuring value is squared. Sqrt – square root of the measuring value. Inv – reciprocal of the measuring value. InvSq – reciprocal of the measuring value is squared. InvSt – square root of reciprocal of the measuring value.</p>
	<p>The setting applies only to <i>CNtFL</i> mode which is available only for the input 1, and determines the period for which the input pulses speed (frequency) is to be converted. For example, the measuring value would be 600 at 10 pulses per second and the setting <i>/min</i>.</p>	<p>Default: /SEC</p> <p>/SEC – conversion of the pulse speed for one second period. /MIN – conversion of the pulse speed for one minute period. /HOUR – conversion of the pulses speed for one hour period.</p>

Table 2

		
Parameter symbol	Description	Range of changes
	<p>The function of the input no. 3 (terminal I3). Each pulse on this input increases the counter no. 3, regardless of the function of the input. The functions assigned to the input refer to the control of the inputs configured to work in the counter mode.</p>	<p>Default: NONE</p> <p>NONE – no function C1 SS, C2 SS – control of the main input (counter modes). An active signal at the input starts the counter and counting. The counter is stopped at no signal at the input - the pulses are not counted. The counter operation is controlled by the input level. C1 STA, C2 STA – start the counter. Edge control - input signal starts the counter. C1 STP, C2 STP – stop the counter. Edge control - input signal stops the counter. C1 RST, C2 RST – input signal resets the counter. The initial value of the counter (after a reset) depends on set counting direction (see the parameter <i>CONSt</i>) . C2 DIR – change counting direction. During an active signal the counting direction of the additional input of the counter (I2) is changed. C12SS – control of the main input and the additional input (counter modes). An active signal at the input starts the counters and counting the pulses. The counters are stopped at no signal at the input - the pulses are not counted. The counters are controlled by the level.</p> <p>Note: C1 refers to the main input (I1) and C2 refers to the additional input (I2).</p>
	<p>Minimum duration of a low level on meter input I3 before it is considered as the low level. Pulses with a shorter low level duration are ignored. The setting is expressed in milliseconds.</p>	<p>Default: 10</p> <p>0...65535</p>
	<p>Minimum duration of a high level on meter input I3 before it is considered as the high level. Pulses with a shorter high level duration</p>	<p>Default: 0</p>

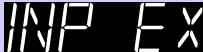

	are ignored. The setting is expressed in milliseconds.	
	The function of the input no. 4 (terminal I4).	Default: NONE The setting range is the same as for IN3 F parameter.
	Minimum duration of a low level on meter input I4 before it is considered as the low level. Pulses with a shorter low level duration are ignored. The setting is expressed in milliseconds.	Default: 10 0...65535
	Minimum duration of a high level on meter input I4 before it is considered as the high level. Pulses with a shorter high level duration are ignored. The setting is expressed in milliseconds.	Default: 10 0...65535

Table 3







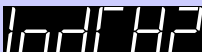

 - main input individual characteristic configuration (terminals I1A and I1B)  - additional input individual characteristic configuration (terminal I2).		
Parameter symbol	Description	Range of changes
	Enable or disable the individual characteristics. The OFF setting makes possible to disable the individual characteristic function.	Default: OFF OFF – individual characteristic disabled. ON – individual characteristic enabled.
	Number of points of the individual characteristic.	Default: 2 2...32
	The first point of the individual characteristic - the value measured directly or the value converted by the mathematical function.	Default: 0 -99999...999999
	The first point of the individual characteristic - expected value for the value X1.	Default: 0 -99999...999999
...		
	Last possible point of the individual characteristic.	Default: 31 -99999...999999
	Last possible point of the individual characteristic – expected value for X32.	Default: 31 -99999...999999

Table 4

		
Parameter symbol	Description	Range of changes
	Selection of the main value displayed on the top line of the display.	Default: VAL VAL – value of the measuring quantity converted by CONST parameter. It is a measuring value without an individual characteristic, without conversion by the mathematical functions and without averaging using the moving window method. VALIND – averaged value of the measuring quantity, converted by the mathematical functions and converted by







		<p>the individual characteristic. Note: Averaging is not active for the counter type measurement modes. VALEXt – Value additionally measured is converted only by CONST parameter (e.g. a frequency during the period measurement). MIN MW – minimum value registered during the averaging period of the moving window method (during the window) MAX MW – maximum value registered during the averaging period of the moving window method (during the window) Note: The window length can be programmed (MAVG parameter).</p>
	<p>Display narrowing lower threshold. If the value to be displayed is below the threshold, the lower limit symbol is displayed</p> 	<p>Default: -99999 -99999...999999</p>
	<p>Display narrowing upper threshold. If the value to be displayed is above the threshold, the upper limit symbol is displayed</p> 	<p>Default: -99999 -99999...999999</p>
	<p>Resolution, display format as the position of the decimal point.</p>	<p>Default: 0000.00 000000 00000.0 0000.00 000.000 00.0000 0.00000 AUTO – automatic position of the decimal point for maximum possible resolution.</p>
	<p>Selection of the unit to be displayed in the lower line of the display, if the function 2L INE is to display the unit.</p>	<p>Default: „----” The list of available units is provided in section 5.1</p>
	<p>Selection of the parameter displayed in the lower line of the display.</p>	<p>Default: UNIt UNIt – unit VAL 1 – measuring value on the main input (I1) without conversion and without averaging, calculated only by CONST parameter. IND 1 – measuring value on the main input converted by the mathematical functions, individual characteristics and averaged. Note: Averaging is not active for the counter type measurement modes. EXt 1 – value additionally measured on the main input (e.g. a frequency during the period measurement). VAL 2 – measuring value on the additional input (I2) without conversion and without averaging, calculated only by CONST parameter. IND 2 – measuring value on the additional input converted by the mathematical functions, individual characteristics and averaged. Note: Averaging is not active for the counter type measurement modes. EXt 2 – value additionally measured on the additional input (e.g. a frequency during the period measurement). clock – current time. INPUTs – displaying the status of all inputs. The character 0 is displayed for the given input, if the input is inactive, or the character 1, if the input is active. Note: The averaging period is defined by MAVG setting.</p>

Table 5









ALARM 1, ALARM 2, ALARM 3, ALARM 4		
Parameter symbol	Description	Range of changes
	Input value controlling the alarm.	<p>Default: IND 1</p> <p>IND 1 – measuring value on the main input converted by the mathematical functions, individual characteristics and without averaging using the moving window method. Note: Averaging is not active for the counter type measurement modes.</p> <p>AVG 1 – the same as <i>IND 1</i>, but averaged using the moving window method.</p> <p>VAL 1 – measuring value on the main input (I1) without conversion and without averaging, calculated only by <i>CONST</i> parameter.</p> <p>Ext 1 – value additionally measured on the main input (e.g. a frequency during the period measurement).</p> <p>IND 2 – measuring value on the additional input converted by the mathematical functions, individual characteristics and without averaging using the moving window method. Note: Averaging is not active for the counter type measurement modes.</p> <p>AVG 2 – the same as <i>IND 2</i>, but averaged using the moving window method.</p> <p>VAL 2 – measuring value on the additional input (I2) without conversion and without averaging, calculated only by <i>CONST</i> parameter.</p> <p>Ext 2 – value additionally measured on the additional input (e.g. a frequency during the period measurement).</p> <p>time – current RTC time in hh.mmss format.</p> <p>Note: The averaging period is defined by <i>MAVG</i> setting.</p>
	Alarm type (see section 5.4.3)	<p>Default: H-oFF</p> <p>n-on – normally enabled n-oFF – normally disabled on – enabled oFF – disabled H-on – permanently enabled (manually) H-oFF – permanently disabled (manually) REG – the state controlled by the MODBUS protocol register.</p>
	Alarm state change lower threshold.	<p>Default: 10 -99999...999999</p>
	Alarm state change upper threshold.	<p>Default: 20 -99999...999999</p>
	Alarm activation delay - the duration in seconds of the alarm state before activating the alarm relay.	<p>Default: 0 0...900</p>
	Alarm deactivation delay - the duration in seconds the state without the alarm before deactivating the alarm relay.	<p>Default: 10 0...900</p>
	Alarm signalization latch. When the function is enabled, after the alarm event ends, the display indicator informing about the alarm status will be flashing signaling the alarm until it is canceled by a combination of buttons   or via the RS-485 interface.	<p>Default: OFF</p> <p>ON – alarm memory is activated. OFF – alarm memory is deactivated.</p>

Table 6

25485		
Parameter symbol	Description	Range of changes
Addr	MODBUS network meter address	Default: 1 1...247
Mode	The transmission frame type of RS-485 interface. Setting the parity bits and the number of stop bits.	Default: F8N1 F8N1 F8N2 F8O1 F8E1
Baud	RS-485 interface baud rate.	Default: 9.6k 2.4k – 2400 b/s 4.8k – 4800 b/s 9.6k – 9600 b/s 14.4k – 14400 b/s 19.2k – 19200 b/s 28.8k – 28800 b/s 38.4k – 38400 b/s 57.6k – 57600 b/s 115.2k – 115200 b/s

Table 7

AnOut		
Parameter symbol	Description	Range of changes
ALTYPE	Selection of the operating mode and the type of analog output used with the option of switching off the output and manual setting the output value.	Default: OFF OFF – Output support is disabled. 4 20MA – current output 4...20 mA. 0 20MA – current output 0...20 mA. 0 10V – voltage output 0...10 V. MAN I – current output. The output value corresponds to the AnMAN setting. MAN U – voltage output. The output value corresponds to the AnMAN setting.
INPV	Input quantity controlling the analog output	Default: U IND 1 – measuring value on the main input converted by the mathematical functions, individual characteristics and without averaging using the moving window method. Note: Averaging is not active for the counter type measurement modes. AVG 1 – the same as <i>IND 1</i> , but averaged using the moving window method. VAL 1 – measuring value on the main input (I1) without conversion and without averaging, calculated only by <i>CONST</i> parameter. Ext 1 – value additionally measured on the main input (e.g. a frequency during the period measurement). IND 2 – measuring value on the additional input converted by the mathematical functions, individual characteristics and without averaging using the moving window method. Note: Averaging is not active for the counter type measurement modes. AVG 2 – the same as <i>IND 2</i> , but averaged using the moving window method. VAL 2 – measuring value on the additional input (I2) without conversion and without averaging, calculated only by <i>CONST</i> parameter. Ext 2 – value additionally measured on the additional input (e.g. a frequency during the period measurement).









		time – current RTC time in hh.mmss format. Note: The averaging period is defined by MAVG setting.
	Displayed (measured) value for which the analog output will have a rated minimum value, in accordance with the programmed output type.	Default: 0 -99999...999999
	Displayed (measured) value for which the analog output will have a rated maximum value, in accordance with the programmed output type.	Default: 100 -99999...999999
	Value of the signal on the analog output for output value manual control. Note: The value is set on the analog output after detecting an error on the measuring input. The maximum possible signal will be generated if the value exceeds the maximum value for a given output type.	Default: 0 0...22

Table 8

		
Parameter symbol	Description	Range of changes
	Setting the current time. Confirmation of the time resets the seconds counter.	Default: (not applicable) 00:2359
	Setting the current date in YYYY.MM.DD format, where: YY – year. MM – month. DD – day of the month.	Default: (not applicable) 00.01.01...99.12.31
	Automatic change of DST and inversely	Default: OFF OFF – automatic time change disabled. ON – automatic time change enabled.
	Password to access the meter configuration. When the set value is different from zero, each attempt to enter the menu of the meter will require entering a password. In case of providing an incorrect password, it will be possible to enter the menu in the monitoring mode without a possibility of make any changes.	Default: 0 0...9999
	Restore default settings. Selecting YES setting will restore all settings to the default settings and set FACT setting to NO.	Default: NO NO – do nothing. YES – restore default settings (factory).

5.4 Meter functions

5.4.1 Measurement

The measuring inputs, main and additional inputs of the N32O meters can work in various measuring modes. Certain functionalities for each type of the inputs are enabled, disabled, or the purpose of a given setting changes, e.g. the filtering time for the fast counter mode is expressed in microseconds, and for the slow counter mode in milliseconds. The table below summarizes the availability of the functions depending on the selected measuring mode.

Table 9

Mode		Functions of measuring inputs		Filtering the waveform (measurement of pulse duration)	Automatic reset External functions Keypad control	Multiplication, division by a constant	Averaging of a measurement using moving window method	Measurement of additional quantity
Symbol	Description	I1A	I1B					
CNTF	Fast pulses counter	Counted pulses	Change of counting direction	+ ¹	+	+	· ²	-
CNT SL	Slow pulses counter	Counted pulses	Change of counting direction	+ ³	+	+	· ²	-
PERIOD	Period measurement	Signal	-	+ ¹	-	+	+	frequency
FREQ	Frequency measurement	Signal	-	+ ¹	-	+	+	period
tACHO	Rotation speed measurement	Signal	-	+ ¹	-	+	+	frequency
ENC*	Incremental encoder support	Signal A	Signal B	-	+	+	-	-
CNTFL*	Pulse counter with pulse frequency measurement	Counted pulses	-	+ ¹	+	+	+ ⁴	frequency
W TIME	Working time counter	-	-	-	+	-	-	-
tIMER	Timer (seconds)	-	-	-	+	-	-	-
tIME*	Current time	-	-	-	-	-	-	-

* Measurement type available only for the main input.

¹ Filtering is enabled if a given parameter (tL or tH) has been set for a time higher than 50 (the setting is expressed in microseconds)

² Moving window averaging is disabled but the minimum and maximum values in the period defined by MAVG setting are registered.

³ Filtering is enabled if a given parameter (tL or tH) has been set for a value higher than 0 (the setting is expressed in milliseconds).

⁴ The measuring frequency is averaged using the moving window method in CNTFL measurement mode.

According to the table above, it is possible to filter the input waveform for several modes. **Filtering the waveform** is based on ignoring the occurring pulses which duration is shorter than the filter setting. When selecting the filtering time, the set time should be treated as a pre-setting, because the measuring waveform has many factors, e.g. input signal amplitude, source signal type (rise and fall times), e.g. open collector output or push-pull output. The graphical example of the filtering is shown in the figure below.

When using the filtering, it is important to keep in mind that the measurement of high level of interference signal may have an additional error, especially during period, frequency or their derivatives measurements. Nevertheless, filtering allows to make the correct measurements of the signals with high level of interference, e.g. when measuring the rotation speed, where the signal is generated by the inductive sensor and there are several changes of the sensor output signal when the gear tooth approaches the sensor due to insufficient hysteresis.

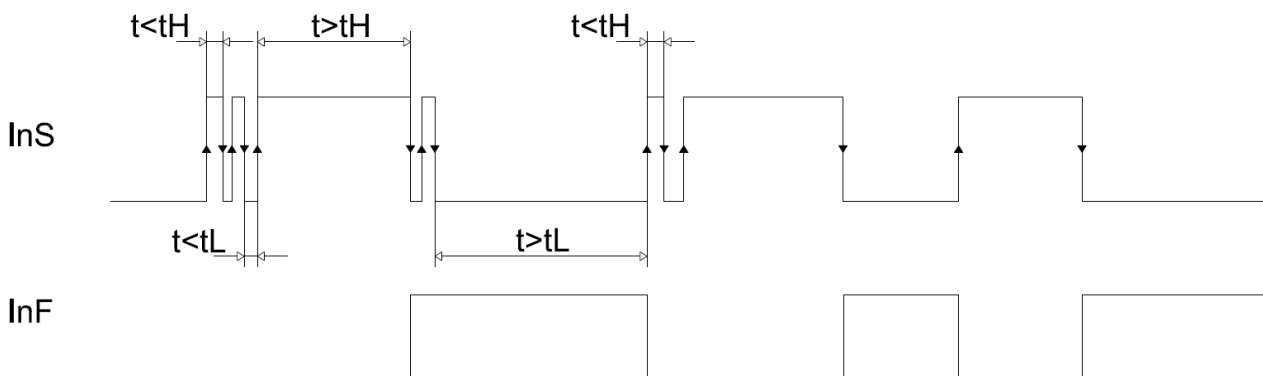

Fig. 11: Graphical example of the signal filtering.

Figure 11 shows how the filter works, where the InS signal is a disturbed input signal, while the InF signal is the signal after passing the filter, and t_L and t_H are the filter settings. The signal levels with the times shorter than the filter settings are ignored and do not change the state of the filtered signal. The testing of the pulse duration is done each time after the state change at the meter input.

A different filtering method was used in the fast change pulse counter mode. Filtering in this case is based on triggering a counter to count down at each edge of the input signal. The setting of the enabled counter corresponds to the set minimum pulse duration. When the counter counts up to 0, and there has been no change of the input status during this period, the given level is considered as correct. In this case, the change of the filtered signal happens each time the counter counts down to 0, and the pulse counting occurs when the filtered signal changes from inactive to active.

During the measurements, the main measuring value in the main and the additional channels may be changed by a number of mathematical operations e.g. averaging, dividing or multiplication by a constant, conversion by the mathematical functions and by the individual characteristics. The sequence of operations is shown in Figure 12. Not all the conversion functions are available for every type of the measurement (see the table above) and the main displayed value can be changed to another measuring value (d^{VAL} parameter from the d^{ISPL} menu). For simplicity, the figure shows only one measuring channel and the alarms and the analog output control of the real time clock has been omitted.

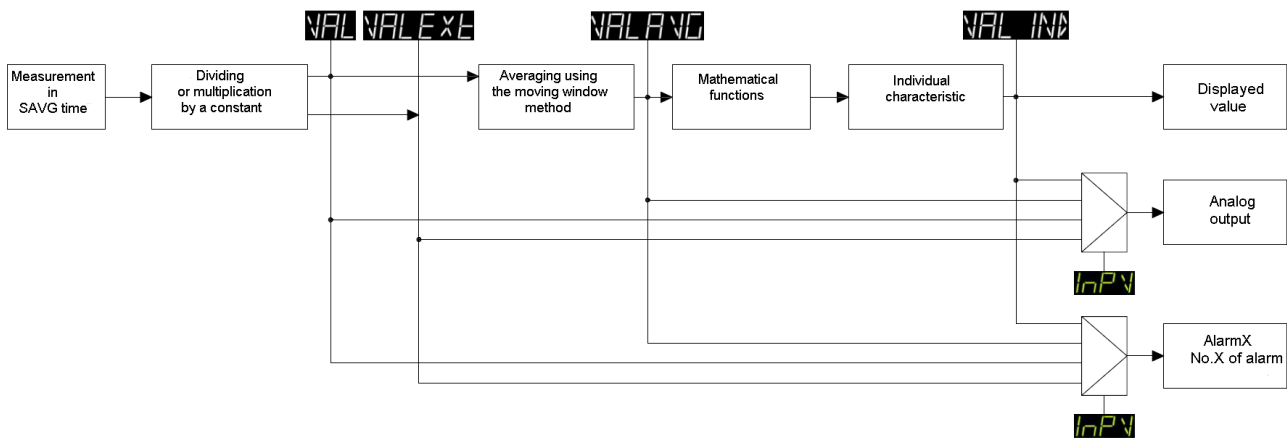

Fig. 12: Measurement recalculation.

Additionally, the range of the values displayed on the main display field (display upper line) can be limited by the user by defining the minimum and maximum displayed value. Exceeding set lower threshold of the measurement (the measuring value lower than the set limit value) causes to display information about exceeding the lower limit, and exceeding set upper threshold of the measuring range (measuring value greater than the set limit value) causes to display information about exceeding the upper limit.

All measuring parameters are available via the RS-485 interface, including the basic measuring values e.g. a frequency when measuring a rotation speed. Additionally, in order to facilitate a control of the measuring signals, the intermediate measuring values, such as values not converted by the individual characteristic or not averaged, were also stored in MODBUS interface registers (see Section 5.6.4).

5.4.1.1 Fast changing pulses counter

Counter main features:

- Counting the pulses with a frequency of up to 20 kHz.
- Meter triggering by the edge of the input signal.
- Input waveform filtering (for duration of a given level > 50 μ s).
- 64-bit basic pulse counter (without division/multiplication).
- Possibility to program the basic counting direction (up or down).
- Possibility to switch the counting direction with the I1B input for the main input or the I3 or I4 binary input for the additional input (after programming the input).
- Possibility to control the counter (start, stop, reset) using the meter keypad, the RS-485 interface and via the programmable binary inputs I3 and I4.
- Registration of the minimum and maximum value in a configurable time window.
- Active math functions.

- Active individual characteristic.

Configuration parameters:

- **SCAL** – selection of the operation to be performed on the counted number of pulses of the meter. Possibility to select division or multiplication by the value defined by CONST parameter.
- **CONST** – defines the value by which the counted basic number of pulses will be multiplied or divided. If CONST value is less than zero the basic counting direction of the counter is set to down counting.
- **CAUTO** – for basic up counting direction (CONST > 0) it defines the value up to which the counter will count. For the down counting direction (CONST < 0), it defines the initial value set after the counter reaches zero or the value after resetting the counter. It is important when setting CAUTO parameter that the setting value should be the value that the counter will reach before the conversion by the mathematical functions and the individual characteristics (CONST setting value is automatically taken into account by the meter).
- **tL** – minimum duration in microseconds of the low input level (inactive state) before it is considered as the low level. Low level filtering is active for tL setting higher than 50.
- **tH** – minimum duration in microseconds of the high input level (active state) before it is considered as the high level. High level filtering is active for tH setting higher than 50.
- **bCtrl** – permission to control the counter using the meter keypad. The control functions using the meter buttons are enabled for ON setting. The following operations can be done using the keypad: start/stop counting, counter reset.
- **SAVG** – the setting defines for the counter mode only data acquisition period for the averaging algorithm using the moving window method. The setting defines the multiplicity of 100 milliseconds, e.g. data acquisition period is 1000 ms for the setting 10.
- **MAVG** – number of the measurements with a period based on SAVG setting defines the time interval in which the minimum and maximum value will be determined. Counting the average value using the moving window method in the counter mode is not available.
- **Math** – type of the mathematical operation converting the value of counted pulses. The user can select the type of operation or disable the function by selecting *NONE* setting.
- **CFtIM** – not applicable.

5.4.1.2 *Slow changing pulses counter*

Counter main features:

- Counting the pulses with a frequency of up to 500 Hz.
- Input status scanning with a frequency of 1kHz.
- Input waveform filtering (for duration of a given level > 0 ms).
- 64-bit basic pulse counter (without division/multiplication).
- Possibility to program the basic counting direction (up or down).
- Possibility to switch the counting direction with the I1B input for the main input or the I3 or I4 binary input for the additional input (after programming the input).
- Possibility to control the counter (start, stop, reset) using the meter keypad, the RS-485 interface and via the programmable binary inputs I3 and I4.
- Registration of the minimum and maximum value in a configurable time window.
- Active math functions.
- Active individual characteristic.

Configuration parameters:

- **SCAL** – selection of the operation to be performed on the counted number of pulses of the meter. Possibility to select division or multiplication by the value defined by CONST parameter.
- **CONST** – defines the value by which the counted basic number of pulses will be multiplied or divided. If CONST value is less than zero the basic counting direction of the counter is set to down counting.
- **CAUTO** – for basic up counting direction (CONST > 0) it defines the value up to which the counter will count. For the down counting direction (CONST < 0), it defines the initial value set after the counter reaches zero or the value after resetting the counter. It is important when setting CAUTO parameter that the setting value should be the value that the counter will reach before the conversion by the mathematical functions and the individual characteristics (CONST setting value is automatically taken into account by the meter).
- **tL** – minimum duration in milliseconds of the low input level (inactive state) before it is considered as the low level. Low level filtering is active for tL setting higher than 0.
- **tH** – minimum duration in milliseconds of the high input level (active state) before it is considered as the high level. High level filtering is active for tH setting higher than 0.

- **bCtrl** – Permission to control the counter using the meter keypad. The control functions using the meter buttons are enabled for ON setting. The following operations can be done using the keypad: start/stop counting, counter reset.
- **SAVG** – the setting defines for the counter mode only data acquisition period for the averaging algorithm using the moving window method. The setting defines the multiplicity of 100 milliseconds, e.g. data acquisition period is 1000 ms for the setting 10.
- **MAVG** – number of the measurements with a period based on SAVG setting defines the time interval in which the minimum and maximum value will be determined. Counting the average value using the moving window method in the counter mode is not available.
- **Math** – type of the mathematical operation converting the value of counted pulses. The user can select the type of operation or disable the function by selecting *NONE* setting.
- **CFtim** – not applicable.

5.4.1.3 **Period measurement**

Measurement main features:

- Wide range of period measurement (from 50 μ s to 60 s) with the possibility of limiting the measurement time.
- High measurement resolution.
- Programmable measurement time (gating).
- Automatic change of the measurement method depending on the frequency of the input signal (counting the internal pulses within the input signal period or counting the number of the external pulses in the set gating time).
- High frequency of the internal reference signal generator (39 MHz).
- Input waveform filtering (for duration of a given level > 50 μ s).
- Additional frequency measurement.
- Possibility of simple measurement conversion by multiplying or dividing by a constant.
- Possibility of measurement averaging using the moving window method with registering the minimum and maximum value in a given averaging time.
- Active math functions.
- Active individual characteristic.

Configuration parameters:

- **SCAL** – selection of the operation to be performed in the measured period of the input signal. Possibility to select division or multiplication by the value defined by **CONSt** parameter.
- **CONSt** – defines the value by which the value of the measured period will be multiplied or divided. This setting enables a quick change of the basic unit of the measuring period, e.g. from seconds to milliseconds (the value is multiplied by 1000).
- **CAUTO** – not applicable.
- **tL** – minimum duration in microseconds of the low input level (inactive state) before it is considered as the low level. Low level filtering is active for **tL** setting higher than 50 μ s.
- **tH** – minimum duration in microseconds of the high input level (active state) before it is considered as the high level. High level filtering is active for **tH** setting higher than 50 μ s.
- **bCtrl** – not applicable.
- **SAVG** – measurement period (gating) of the input waveform expressed as a multiple of 100 milliseconds. This setting also defines the maximum duration of the measurements, thus defining the maximum period of the measuring input signal. It is recommended that the value of this setting should be about twice the maximum period of the measuring signal. The meter will display the upper range limit symbol, if during the time set by this setting a full period of the measuring signal is not present.
- **MAVG** – number of the measurements with a period based on **SAVG** setting which is averaged using the moving window method. The setting defines the window width and the averaging time of the measurements. The minimum and maximum values are registered within the defined window range.
- **Math** – type of the mathematical operation converting the value of the measuring quantity. The user can select the type of operation or disable the function by selecting *NONE* setting.
- **CFtIM** – not applicable.

5.4.1.4 Frequency measurement

Measurement main features:

- Wide range of frequency measurement (from 0.02 Hz do 20,000 Hz) with the possibility of limiting the measurement time (lower value of frequency).

- High measurement resolution.
- Programmable measurement time (gating).
- Automatic change of the measurement method depending on the frequency of the input signal (counting the internal pulses within the input signal period or counting the number of the external pulses in the set gating time).
- High frequency of the internal reference signal generator (39 MHz).
- Input waveform filtering (for duration of a given level > 50 μs).
- Additional period measurement.
- Possibility of simple measurement conversion by multiplying or dividing by a constant.
- Possibility of measurement averaging using the moving window method with registering the minimum and maximum value in a given averaging time.
- Active math functions.
- Active individual characteristic.

Configuration parameters:

- **SCAL** – selection of the operation to be performed in the measured period of the input signal. Possibility to select division or multiplication by the value defined by **CONSt** parameter.
- **CONSt** – defines the value by which the value of the measured period will be multiplied or divided. This setting enables a quick change of the basic unit of the measuring frequency, e.g. from Hz to kHz (the value is divided by 1000).
- **CAUTO** – not applicable.
- **tL** – minimum duration in microseconds of the low input level (inactive state) before it is considered as the low level. Low level filtering is active for **tL** setting higher than 50 μs .
- **tH** – minimum duration in microseconds of the high input level (active state) before it is considered as the high level. High level filtering is active for **tH** setting higher than 50 μs .
- **bCtrl** – not applicable.
- **SAVG** – measurement period (gating) of the input waveform expressed as a multiple of 100 milliseconds. This setting also defines the maximum duration of the measurements, thus defining the minimum frequency of the measuring input signal. It is recommended that the value of this setting should be about twice the maximum

period of the measuring signal. The meter will display the value 0, if during the time set by this setting a full period of the measuring signal is not present.

- **MAVG** – number of the measurements with a period based on SAVG setting which is averaged using the moving window method. The setting defines the window width and the averaging time of the measurements. The minimum and maximum values are registered within the defined window range.
- **Math** – type of the mathematical operation converting the value of the measuring quantity. The user can select the type of operation or disable the function by selecting *NONE* setting.
- **CFtIM** – not applicable.

5.4.1.5 *Rotation speed measurement*

Measurement main features:

- Wide range of rotation speed measurement (frequency measurement from 0.02 Hz do 20,000 Hz) with the possibility of limiting the measurement time (lower value of speed).
- Automatic conversion of the measuring signal into speed expressed in revolutions per minute.
- High measurement resolution.
- Programmable measurement time (gating).
- Automatic change of the measurement method depending on the frequency of the input signal (counting the internal pulses within the input signal period or counting the number of the external pulses in the set gating time).
- High frequency of the internal reference signal generator (39 MHz).
- Input waveform filtering (for duration of a given level > 50 μ s).
- Additional input signal period measurement.
- Possibility of simple measurement conversion by multiplying or dividing by a constant - determination of the number of pulses per one rotation.
- Possibility of measurement averaging using the moving window method with registering the minimum and maximum value in a given averaging time.
- Active math functions.
- Active individual characteristic.

Configuration parameters:

- **SCAL** – selection of the operation to be performed on the measured value of a

rotation speed. Possibility to select division or multiplication by the value defined by **CONSt** parameter. This parameter should normally be set to *DIV* value, then **CONSt** value defines the number of pulses per one rotation.

- **CONSt** – defines the value by which the value of a rotation speed will be multiplied or divided. **CONSt** value should as a standard correspond to the number of pulses per one rotation.
- **CAUTO** – not applicable.
- **tL** – minimum duration in microseconds of the low input level (inactive state) before it is considered as the low level. Low level filtering is active for **tL** setting higher than 50 μ s.
- **tH** – minimum duration in microseconds of the high input level (active state) before it is considered as the high level. High level filtering is active for **tH** setting higher than 50 μ s.
- **bCtrl** – not applicable.
- **SAVG** – measurement period (gating) of the input waveform expressed as a multiple of 100 milliseconds. This setting also determines the maximum time of the measurements and defines the minimum speed (frequency) of the measuring input signal. It is recommended that the value of this setting should be about twice the maximum period of the measuring signal. The meter will display the value 0, if during the time set by this setting a full period of the measuring signal is not present.
- **MAVG** – number of the measurements with a period based on **SAVG** setting which is averaged using the moving window method. The setting defines the window width and the averaging time of the measurements. The minimum and maximum values are registered within the defined window range.
- **Math** – type of the mathematical operation converting the value of the measuring quantity. The user can select the type of operation or disable the function by selecting *NONE* setting.
- **CFtIM** – not applicable.

5.4.1.6 Encoder (only the main input)

Measurement main features:

- Quadrature encoder support.
- Pulse counting on each edge of the signal on I1A input.
- Pulse counting on both edges of the signal on I1A input.

- The control of the signal on I1B input (no signal changes on this input will stop counting despite the correct waveform on I1A input).
- Automatic detection of the rotation direction.
- High operating frequency (up to 20,000 Hz).
- Possibility to set the meter range.
- Internal 32-bit hardware counter.
- Possibility of simple measurement conversion by multiplying or dividing by a constant.
- Registration of minimum and maximum value of the measurement in a given averaging time.
- Active math functions.
- Active individual characteristic.

Configuration parameters:

- **SCAL** – selection of the operation to be performed on the counted pulses. Possibility to select division or multiplication by the value defined by CONST parameter.
- **CONST** – defines the value by which the counted number of pulses will be multiplied or divided. It is important when determining the value of the multiplier or the divisor that the encoder counter is a 32-bit counter and setting the division value reduces the maximum number of counted pulses by a multiple of CONST value. For example, dividing by 1000 will set the counter to actually count 1000 times more pulses, so the maximum value it can count to will be 1000 times less.
- **CAUTO** – defines the maximum value of the counted pulses (counter range). Set value of the multiplier or divider (CONST parameter) is automatically used by the meter. The value increases to CAUTO value and then becomes zero when the encoder turns clockwise. The value decreases until it reaches 0 and then becomes CAUTO value when the encoder turns counterclockwise.
- **tL** – not applicable.
- **tH** – not applicable.
- **bCtrl** – not applicable.
- **SAVG** – the setting defines for the encoder mode only data acquisition period for the averaging algorithm using the moving window method. The setting defines the multiplicity of 100 milliseconds, e.g. data acquisition period is 1000 ms for the setting 10.

- **MAVG** – number of the measurements with a period based on SAVG setting defines the time interval in which the minimum and maximum value will be determined. Counting the average value using the moving window method in the encoder mode is not available.
- **Math** – type of the mathematical operation converting the value of the measuring quantity. The user can select the type of operation or disable the function by selecting *NONE* setting.
- **CFtIM** – not applicable.

5.4.1.7 Pulse counter with pulse speed measurement (main input only)

Measurement main features:

- Simultaneous measurement of the number of pulses and the input signal frequency.
- Possibility to determine the number of pulses per a count with automatic use of the set value of the frequency measurement.
- Possibility of rescaling the measuring frequency to another time unit.
- Unidirectional counter for counting up.
- Averaging the measured frequency using the moving window method with registering the minimum and maximum value in a given averaging time.
- Possibility to control the counter using the meter keypad, binary inputs or via the RS-485 interface.
- Wide range of frequency measurement (from 0.02 Hz do 20,000 Hz) with the possibility of limiting the measurement time (lower value of frequency).
- High measurement resolution.
- Programmable time of frequency measurement (gating).
- Automatic change of the measurement method depending on the frequency of the input signal (counting the internal pulses within the input signal period or counting the number of the external pulses in the set gating time).
- High frequency of the internal reference signal generator (39 MHz).
- Input waveform filtering (for duration of a given level > 50 μ s).
- Active math functions.
- Active individual characteristic.

Configuration parameters:

- **SCAL** – selection of the operation to be performed on the counted number of

pulses and measured pulse speed (frequency). Possibility to select division or multiplication by the value defined by *CONST* parameter. This parameter should normally be set to *DIV* value, and *CONST* parameter should define the number of pulses per single count (a constant of the connected energy meter, flow meter, etc.).

- **CONST** – defines the value by which the counted number of pulses will be multiplied or divided and measured value of frequency. The parameter defines the number of pulses per a single count and its value is also used during the pulse speed measurement so that the measured frequency is converted into the pulse speed.
- **CAUTO** – maximum value of the counter after exceeding which the counter will have the value zero.
- **tL** – minimum duration in microseconds of the low input level (inactive state) before it is considered as the low level. Low level filtering is active for *tL* setting higher than 50 μ s.
- **tH** – minimum duration in microseconds of the high input level (active state) before it is considered as the high level. High level filtering is active for *tH* setting higher than 50 μ s.
- **bCtrl** – Permission to control the counter using the meter keypad. The control functions using the meter buttons are enabled for *ON* setting. The following operations can be done using the keypad: start/stop counting, counter reset.
- **SAVG** – measurement period (gating) of the input waveform expressed as a multiple of 100 milliseconds. This setting also defines the maximum duration of the measurements, thus defining the minimum frequency of the measuring input signal. It is recommended that the value of this setting should be about twice the maximum period of the measuring signal. The meter will recognize the value of the measuring frequency as zero, if during the time set by this setting a full period of the measuring signal is not present. This setting has no effect on the pulse counting.
- **MAVG** – number of the measurements with a period based on *SAVG* setting which is averaged using the moving window method. The setting defines the window width and the averaging time of the measurements. The minimum and maximum values are registered within the defined window range. Averaging using the moving window method in this operation mode of the meter refers to the pulse speed (frequency). The value of counted pulses is not averaged.
- **Math** – type of the mathematical operation converting the counted pulses value without modifying the measured pulse speed. The user can select the type of operation or disable the function by selecting *NONE* setting.
- **CFtim** – setting of the pulse speed conversion. The pulses are counted and the input signal frequency is measured during a normal operation of the meter, and then

converted by CONST scaling value. The pulse speed determined this way corresponds to the speed expressed in pulses per second. Since in the measuring systems it is much more convenient to use the speeds expressed in speed per minutes or hours, the N320 meters have introduced CftIM parameter that allows a direct conversion of speed to the desired time: seconds (/SEC), minutes (/MIN) or hours (/HOUR).

The CNTFL measurement mode is dedicated for the N320 meter working with different counters, flow meters and length measurement systems. This mode enables counting a consumption and production with simultaneous evaluation of the dynamics of this parameter. For example, connecting a flow meter enables to count the consumption of a given medium and determine the flow rate, e.g. in m³/h. Another example is a length measurement of the film during a production with simultaneous measurement of manufacturing velocity (productivity), e.g. in m/min.

Configuration example

Let's assume that the N320 meter will work with a flow meter that generates 100 pulses per m³ of water. The upper line of the display should indicate a flow counter value, and in the lower line should display the flow rate in m³/h. The N320 meter should be configured according to the following parameters:

- *ItYPE* (input type) set to *CntFL* mode.
- *SCAL* (operation type) set to *DIV*.
- *CONST* (rescaling constant) set to 100,000.
- *CAUTO* (counter upper value) set to the value, e.g. 999999.
- *tL*, *tH* (minimum duration of signal levels) set to the value according to the requirements of the flow meter, e.g. to 1000. So the pulses with a duration shorter than 1 ms will be ignored.
- *BCtrl* – set according to the requirements, e.g. set to OFF, so it will not be possible to stop, start or reset the counter - the counter is enabled by default.
- *SAVG* – speed measurement time - set to 10, what will correspond to the maximum speed measurement time of 1 second, and the frequencies below 1 Hz will not be measured.
- *MAVG* – set measurement averaging using the moving window method to the value, e.g. 1 - disabled averaging using the moving window method.
- *MAth* – disable the mathematical functions - the setting *NONE*.
- *CFtIM* – set to the value */hour*.

Set *dVAL* parameter to *VALIND* and *2LINE* parameter to Ext 1 in *dISPLAY* menu after

completed measurement configuration. Set the required displayed resolution, e.g. 000000 format, and the meter will display with an accuracy of 1 m³.

5.4.1.8 Working time measurement

Measurement main features:

- Working time measurement with an automatic display format depending on the value of the working time counter.
- Working time counter can be configured for up or down counting.
- Possibility of changing the counting direction using the binary input I1B of the main input or using the binary inputs I3 or I4 of the additional input.
- Possibility to program the maximum value for up counting or the initial value for a counter configured for down counting.
- 64-bit seconds counter available via the RS-485 interface.
- Possibility to control the counter (start, stop, reset) using the meter keypad, the RS-485 interface and via the programmable binary inputs I3 and I4.
- Registration of the minimum and maximum value in a configurable time window.
- Automatically ignored mathematical functions.
- Automatically ignored individual characteristics.

Configuration parameters:

- **SCAL** – not applicable.
- **CONSt** – The value only defines the counting direction. The working time counter counts up for the values greater than zero and counts down for the values less than zero. The signal on the input controlling the counting direction changes the counting direction in relation to the programmed direction.
- **CAUTO** – maximum value of the counter after exceeding which the counter will have the value zero for a positive counting configuration. Counter initial value for down counting. Automatic resetting of the counter to the value set in *CAUTO* takes place during a down counting after reaching the value zero. The value is in HH.MMSS format.
- **tL** – not applicable.
- **tH** – not applicable.
- **bCtrl** – Permission to control the counter using the meter keypad. The control functions using the meter buttons are enabled for *ON* setting. The following operations can be done using the keypad: start/stop counting, counter reset.

- **SAVG** – the setting defines for the working time counter mode only data acquisition period for the averaging algorithm using the moving window method. The setting defines the multiplicity of 100 milliseconds, e.g. data acquisition period is 1000 ms for the setting 10.
- **MAVG** – number of the measurements with a period based on SAVG setting defines the time interval in which the minimum and maximum value will be determined. Counting the average value using the moving window method in the counter mode is not available.
- **Math** – not applicable.
- **CFtIM** – not applicable.

5.4.1.9 Time measurement

T

5.4.1.10 Additional counters I3 and I4.

The binary inputs I3 and I4 of the N320 meters use the unidirectional pulse counters that count the pulses independently of the functions assigned to the inputs.

The value of the counted pulses and the counters control are available via the RS-485 interface. The counters input signals are filtered by the programmable filters (the parameters tL3, tH3, tL4 and tH4). Counters main features:

- 64-bit counters.
- Unidirectional counters.
- Maximum input frequency 500 Hz.
- Input scanning speed 1 ms.
- Possibility to control the counters (start, stop, reset) only via the RS-485 interface.



5.4.1.11 Averaging the measuring quantities

The measuring values that are not counter type values such as period, frequency and rotation speed can be averaged using the moving window method. A single measurement is made within the set **SAVG** (measurement) time. This parameter defines the measurement time and is expressed as a multiplicity of 100 ms period, e.g. the measurement time will be one second for the setting 10.

Each single measurement in **SAVG** time is moved to the averaging function using the moving window method, where the individual measurements are stored in the array, so when adding a new item to the array it replaces the oldest item. The average value is

calculated every time a new element is stored in the array. The number of array elements (window length) is defined by the user in meter configuration (MAVG parameter). The number of array elements determines the averaging period, because it is a multiple of the time of a single measurement, e.g. for the previous example, setting the MAVG parameter to 60 will set the averaging time at 60 seconds, and the value will be updated every 1 second, i.e. every time a single measurement is done.

5.4.1.12 Minimum and maximum measuring values

The N32 meter continuously measures the signal on the indicated input. The measuring value (displayed) is constantly monitored, if the measuring range is not exceeded during the measurement. If the value is smaller than the current minimal value, then the new minimal value is saved. When the measuring (displayed) value is higher than the current maximum value, then the new maximum value is saved. The minimum and maximum value is available via the interface and from the panel of the meter. Press the button  to display the minimum value. Press the button  to display the maximum value. The minimum / maximum value is displayed for 2 seconds, then the meter automatically returns to displaying the measuring value.





Reset of the minimum / maximum value can be done via the interface or directly using the meter keypad. Press a combination of buttons   to reset the minimum value, and press a combination of buttons   to reset the maximum value. Each reset of the minimum or maximum value using the buttons is confirmed by a message - an example the message is shown below.



Fig. 13: The message after resetting the maximum value.

5.4.1.13 Mathematical functions

The N32O meters have a functionality that enables the conversion of the measuring value on the main or auxiliary input by the selected mathematical function (MATh setting):

- Sqr – measured value is squared.
- Sqrt – square root of the measured value.
- Inv – reciprocal of the measured value.
- InvSq – reciprocal of the measured value is squared.
- InvSt – square root of reciprocal of the measured value.

The mathematical functions can be disabled by the setting the parameter MatH to OFF.

Note: Definition of the mathematical functions is carried out independently for the main measuring input and for the auxiliary input, and it is available only for the selected measurement modes (see Table 9).

5.4.1.14 Individual characteristic

The measuring value measured by the N320 meter can be converted by the provided individual characteristic (separate for the main input and for the auxiliary input). It is important when using the mathematical functions to pay attention to the order of operations - the mathematical functions are completed before the individual characteristic, which should be taken into account when specifying the points coordinates x values. The user can define up to 31 linearization functions by defining 32 points of the characteristic. Parameters of the individual characteristic parameters are available from the menu level and via the interface. Programming client-specific characteristic requires to define the number of points and then determining their values. Defining points of the individual characteristic requires to determine the points of the characteristic by providing the X and Y values of each point. The X value of the point is the measuring value converted by the mathematical functions (if they are enabled), while Y value specifies the desired value for the measurement with X value. During a programming, however, the subsequent entered points should meet the dependence:

$$X_1 < X_2 < X_3 < \dots X_n,$$

where X_n - the last point of the characteristic.

Failure to observe the above dependence will disable the individual characteristic and set the error flag in the meter status register.

An example of the graphic interpretation of the individual characteristic is shown in the Fig. 12.

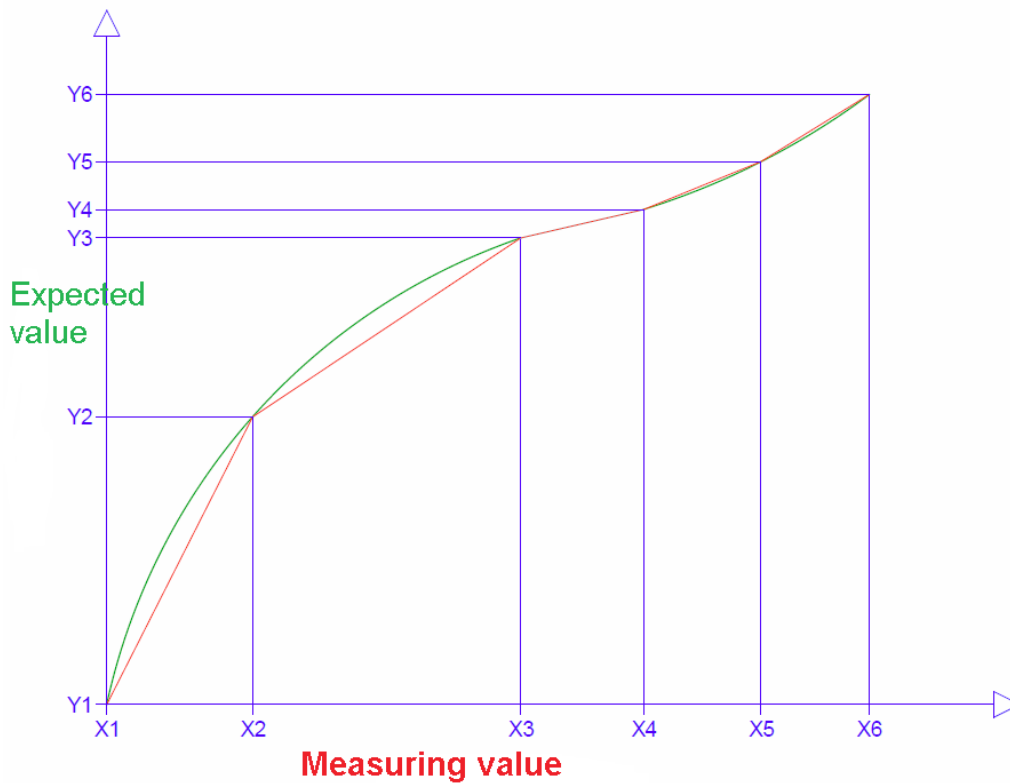

Fig. 14: Example of the individual characteristic.

The approximating functions strongly differ from the linear function, so it is important to keep in mind that the higher the number of the introduced points, the smaller the linearization error of the function.

The value for the measuring values smaller than X_1 is converted according to the first linear function determined on the basis of the points (X_1, Y_1) and (X_2, Y_2) . Similarly, the conversion for the measured values higher than the last entered point is made using the last selected function.

Note: The individual characteristic is available only for the selected measurement modes (see Table 9).

5.4.2 Analog output

The N32O meters can have one analog output (depends on the ordering code) connected to the meter terminals as a voltage output (0...10 V output) and as a current output (0...20 mA or 4...20 mA). The analog output is galvanically separated from the other meter circuits. Selection of the output type to be used can be done during the output configuration. It is not possible to use the voltage and current output at the same time because it is physically one output with two signals connected to the terminals. It is very important when using an output to choose the type of it that is actually being used. Otherwise, the output value will not match the expected output signal.

The following parameters should be defined during the output configuration:

- **AtYPE** – type of output signal that will be used. Additionally, the manual operation modes are available (separate for the voltage output and for the current output), where AnMAN setting defines the exact expected value on the analog output.
- **InPV** – setting which defines the quantity that will control the analog output signal.
- **AnLo** – lower value of the control signal in accordance with InPV parameter, which the minimum signal value on the analog output corresponds to.
- **AnHi** – upper value of the control signal in accordance with InPV parameter, which the maximum (rated) signal value on the analog output corresponds to.
- **AnMAN** – the parameter has two applications. First, it is the value of the signal (voltage or current) during a manual control of the output. Second, to use a set value when the signal controlling the output has an incorrect value, e.g. exceeded measuring range. In such case the signal on the output will be set according to this setting.

Thus, configuration of the output requires to specify five parameters. An example of an output configuration is shown below.

Let's assume that the input signal will be the frequency and the measuring range will be 500 Hz, and for this range the output should change in the range of 4...20 mA. The settings for such case should be as follows:

- AtYPE = 4 20MA.
- InPV = IND 1.
- AnLo = 0.
- AnHi = 500.
- AnMAN = 22. The value on the analog output will be 22 mA in case of a measurement error.

5.4.3 Alarm outputs

The N32O meters are equipped with one alarm output as standard. They can have 4 alarm outputs as an option, including three outputs with a switching contact. The alarm output element are electro-magnetic relays. If the meter is physically equipped with one alarm, 4 alarms are still available in the meter menu. In this case, the alarms 2 to 4 can have a indication functions by controlling the alarm indicator on the screen and via the RS-485 interface (alarm states in the meter registers).

Each alarm output is independently configured and can be configured to work in one of six modes. It is possible to select the value controlling the alarm (see Fig. 9), define the alarm state change thresholds and define delays alarm activation and deactivation for each of

the alarms. Fig. 13 shows how the alarms work in n-on, n-off, off and on modes. Additional manual working modes H-on and H-off enable to permanently activate or deactivate the alarms. An additional REG operation mode has also been added to the alarm type settings. In this mode, the alarm state is controlled via the RS-485 interface by MODBUS protocol registers.

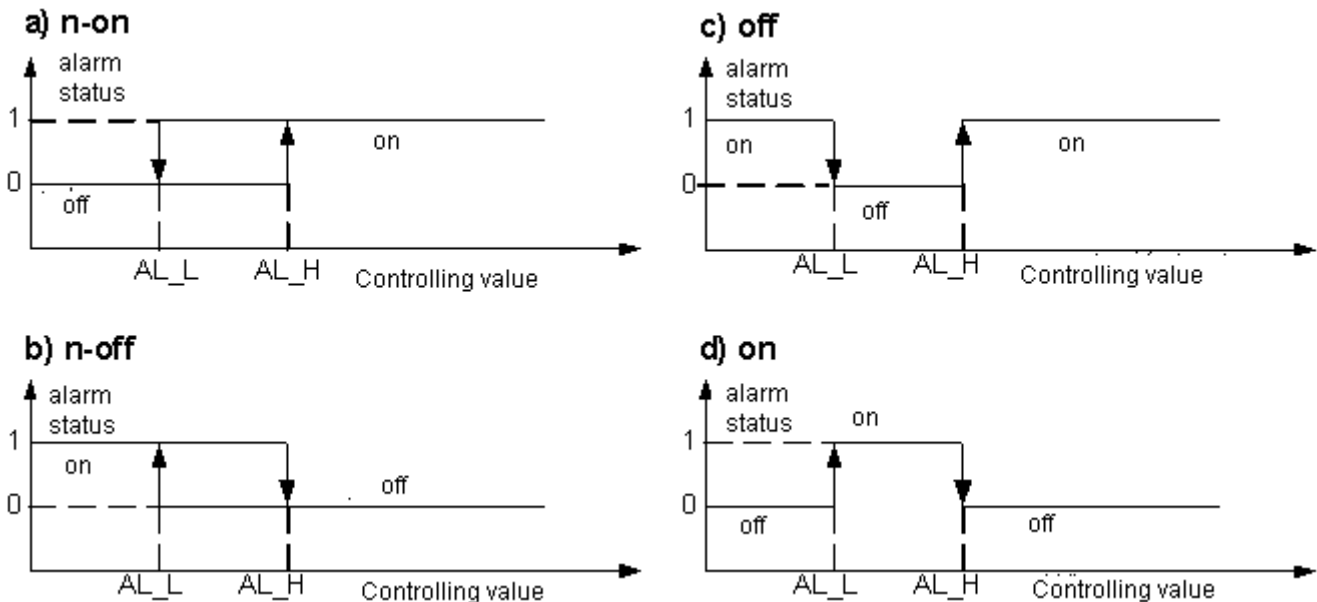

Fig. 15: Alarm types: a) n-on; b) n-off; c) off; f) on.

Designations used in the drawing:

- AL_L – corresponds to PrL setting and determines the alarm state change lower threshold.
- AL_H – corresponds to PrH setting and determines the alarm state change upper threshold.

Note: It is important to keep in mind when configuring the alarms that the entered threshold values should match the dependency $AL_L < AL_P$. Otherwise the dependency will disable the alarms.

Additionally, the alarm functions include the programmable delays of alarm activation and deactivation. The user can define how long the alarm event must last before the alarm relay contacts are switched on and the minimum time of the alarm event end before the relay contacts are switched off. Alarm delays prevent false alarms caused by a short-term change of the measuring value, e.g. during the start-up.

The alarm event could be registered if the alarm memory is enabled.

5.5 RS-485 interface

The N320 meters are equipped as a standard with one RS-485 port connected to the terminals of the lower connector. The interface is galvanically separated from the other circuits of the meter.

The implemented data exchange protocol is compatible with MODBUS RTU standard and allows to save and read all configuration parameters, as well as read all measuring data with data of alarm status, current time, date or other parameters related to the meter status. The transducer works in the network as a *slave* device.

Standard RS-485 allows a direct connection up to 32 devices on a single serial link. The maximum permissible cable length depends on a baud rate, and it is 1200 m for the baud rate 9600 b/s. It is necessary to use additional intermediate-separation circuits e.g. PD51 by LUMEL S.A. to connect more devices or to use a longer connections.

5.5.1 Connection

The terminals A, B and GNDI terminals which location is shown in Fig. 5 allow to connect the RS-485 interface to the N320 meter. It is required to connect the lines A and B in parallel with their equivalents in other devices to obtain the correct transmission.

The connection should be made using twisted pair screened cable in such a way that the A and B lines should be one pair and are connected with their equivalents of other devices in the network. The cable shield should be connected to the protective terminal in close proximity to the N320 meter. The cable shield of the interface cable should be connected to the protective terminal only in one point.

The GNDI line, which is the reference potential for the RS-485 interface, is used for additional protection of the interface line at long connections. Then all GNDI lines of all devices using the same bus should be connected together.

A star connection should be avoided when connecting the devices. The connection should have a bus layout which ends are connected to the termination resistors.

Method of connecting the devices is shown in Fig. 16.

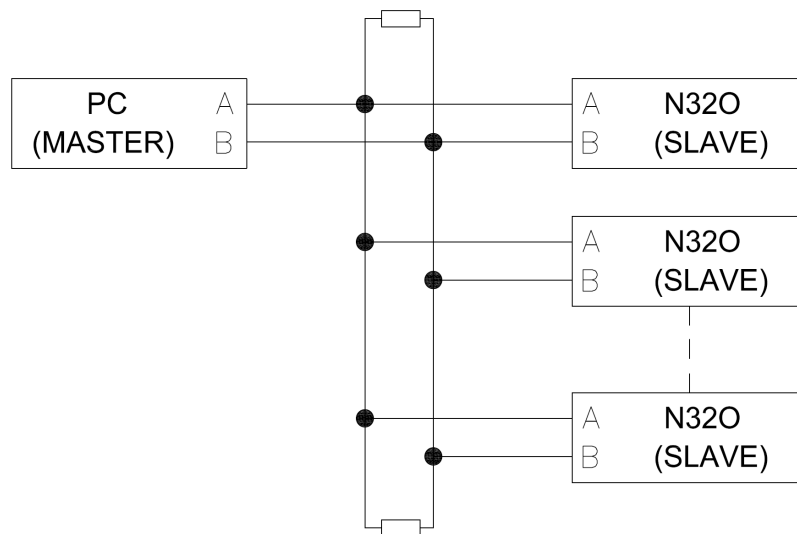

Fig. 16: Connecting the RS-485 interface.

5.5.2 Description of the MODBUS protocol implementation.

The implemented protocol is compliant with the PI-MBUS-300 Rev G specification of Modicon.

It is important to keep in mind when configuring the parameters that the devices using the same bus must meet the following requirements:

- Have a unique address, different from the addresses of other devices connected to the network.
- The same baud rate.
- The same type of transmission mode (single data frame format).

The N320 meters enable programming the following parameters of the RS-485 link:

- Meter address: 1...247.
- Baud rate: 2400, 4800, 9600, 14400, 19200, 28800, 38400, 57600, 115200 [b/s].
- Operation mode: RTU frame format 8n1, 8n2, 8o1, 8e1.
- Maximum response time: 50 ms.

5.5.3 Implemented functions of MODBUS protocol

The following functions of the MODBUS protocol have been implemented in the N320 meters:

- 03 (03h) – readout of registers group.
- 04 (04h) – readout of input registers group.
- 06 (06h) – single register writing.
- 16 (10h) – registers group writing.

- 17 (11h) – *slave* device identification.

5.5.4 Map of the registers

The register map of the N32O meter is divided into separate groups of 16-bit or 32-bit registers. Data stored in 32-bit registers are additionally available in the format of 16-bit registers, with the value of one 32-bit register is stored in two 16-bit registers.

The 32-bit registers store data in the float format compliant with IEEE-754. Bytes sequence: B3 B2 B1 B0 – the oldest byte is transmitted as the first. The 16-bit registers representing 32-bit values in two successive registers have been doubled in another address space with a byte sequence: B1 B0 B3 B2.

The table below shows the register map of the N32O meter. The addresses in the table are the physical addresses. The register number should be increased by 1 when using the programs where the addresses are provided in a logical format.

Address range	Value type	Description
4000 – 4079	16 bits	Readout and write registers - configuration registers
4200 – 4257	16 bits	Readout only registers with system parameter values
7500 – 7521	32 bits (float)	Readout only registers with measuring and calculated values.
7600 – 7744	32 bits (float)	Readout and write registers - registers with configuration data.
7000 – 7043	16 bits	Readout only registers. Registers store the same data as the registers 7500-7519, where one value is stored in two successive registers.
7200 – 7489	16 bits	Readout and write registers. Registers store the same data as the registers 7600-7744, where one value is stored in two successive registers.

5.5.4.1 Registers 4000 – 4079

16-bit readout and write configuration registers.

Address	Permissible values	Default	Description	
Measurement, display and protection of configuration				
4000	0...8	1	Type of measuring signal at the main input	
			Value	Type of measuring signal
			0	Bidirectional counter of fast changing signals.
			1	Bidirectional counter of slow changing signals.
			2	Period measurement.
			3	Frequency measurement.
			4	Rotation speed measurement.
			5	Quadrature encoder support.
			6	Unidirectional counter with speed measurement (frequency)
			7	Working time counter.
8	Timer			
9	Current time.			

4001	0, 1	0	Type of operation used for the measured value on the main input	
			Value	Type of operation
			0	Dividing by a constant.
			1	Multiplication by a constant.
4002	0...65535	0	Minimum duration of a low level on the main input before it is considered as the low level. Value in microseconds or milliseconds (see Section 5.3.2 and 5.4.1).	
4003	0...65535	0	Minimum duration of a high level on the main input before it is considered as the high level. Value in microseconds or milliseconds (see Section 5.3.2 and 5.4.1).	
4004	0, 1	1	Permission to control the main input using the meter keypad.	
			Value	Description
			0	No control using the keypad.
4005	0...5	0	Mathematical functions used for the measuring value on the main input.	
			Value	Description
			0	Disabled.
			1	Square of the measuring quantity.
			2	Square root of the measuring quantity.
			3	Reciprocal of the measuring quantity.
4006	1...600	10	Single measurement time on the main input – gating time. The value is the multiplicity of 100 ms period (SAVG parameter)	
			Number of single measurements averaged using the moving window method (main input).	
4007	1...3600	1	Defines the period for pulse speed conversion in <i>CNTFL</i> measurement mode.	
			Value	Description
			0	Pulse speed expressed as the number of pulses per second.
4008	0...2		1	Pulse speed expressed as the number of pulses per minute.
			2	Pulse speed expressed as the number of pulses per hour.
4009	0...5	1	Type of measuring signal at the additional input	
			0	Bidirectional counter of fast changing signals.
			1	Bidirectional counter of slow changing signals.
			2	Period measurement.
			3	Frequency measurement.
			4	Rotation speed measurement.
			5	Working time counter.
6	Timer			
4010	0, 1	0	Type of operation used for the measured value on the additional input	
			Value	Type of operation
			0	Dividing by a constant.
			1	Multiplication by a constant.
4011	0...65535	0	Minimum duration of a low level on the additional input before it is	

			considered as the low level. Value in microseconds or milliseconds (see Section 5.3.2 and 5.4.1).	
4012	0...65535	0	Minimum duration of a high level on the additional input before it is considered as the high level. Value in microseconds or milliseconds (see Section 5.3.2 and 5.4.1).	
4013	0, 1	1	Permission to control the main input using the meter keypad.	
			Value	Description
			0	No control using the keypad.
			1	Disabled control using the keypad.
4014	0...5	0	Mathematical functions used for the measuring value on the additional input.	
			Value	Description
			0	Disabled.
			1	Square of the measuring quantity.
			2	Square root of the measuring quantity.
			3	Reciprocal of the measuring quantity.
			4	Square of the reciprocal of the measuring quantity.
5	Square root of the reciprocal of the measuring quantity.			
4015	1...600	10	Single measurement time on the additional input – gating time. The value is the multiplicity of 100 ms period (SAVG parameter)	
4016	1...3600	1	Number of single measurements averaged using the moving window method (additional input).	
4017	0...11	0	The function of the binary input no. 3	
			Value	Input function
			0	No function
			1	Enable/Disable the counter of the main input. The counter is enabled if the input is active (control by level)
			2	Enable the counter of the main input. The counter is enabled if the input changes from inactive to active (control by edge).
			3	Disable the counter of the main input. The counter is disabled if the input changes from inactive to active (control by edge).
			4	Reset the counter of the main input. The counter is reset if the input changes from inactive to active (control by edge).
			5	Enable/Disable the counter of the additional input. The counter is enabled if the input is active (control by level)
			6	Enable the counter of the additional input. The counter is enabled if the input changes from inactive to active (control by edge).
			7	Disable the counter of the additional input. The counter is disabled if the input changes from inactive to active (control by edge).
			8	Reset the counter of the additional input. The counter is reset if the input changes from inactive to active (control by edge).
9	Change the counting direction at the additional input. The active state changes the counter counting direction at the additional input to the opposite to the programmed direction.			
10	Enable/Disable the counter of the main and the additional input. The counters are enabled if the input is active (control by level)			

			11	Reset the counters of the main and the additional input. The counters are reset if the input changes from inactive to active (control by edge).
4018	0...65535	10		Minimum duration in milliseconds of the low level on the input no. 3 before it is considered as the low level.
4019	0...65535	10		Minimum duration in milliseconds of the low high on the input no. 3 before it is considered as the high level.
4020	0...11	0		The function of the binary input no. 4. Setting range as the binary input 3 function (register 4017).
4021	0...65535	10		Minimum duration in milliseconds of the low level on the input no. 4 before it is considered as the low level.
4022	0...65535	10		Minimum duration in milliseconds of the low high on the input no. 4 before it is considered as the high level.
4023	0...4	1	Selection of the value displayed on the main display field - measuring value at the main input	
			Value	Description
			0	Value directly measured, not converted by the individual characteristic and the mathematical functions, without averaging using the moving window method.
			1	Measuring value averaged using the moving window method and converted based on the selected mathematical function and the individual characteristics.
			2	Value additionally measured during the measurement of the main value selected according to the configuration of the main input type (e.g. a frequency in the period measurement).
			3	Minimum value of the measuring quantity, averaged and converted using the mathematical functions and the individual characteristic, occurring during the averaging window.
4024	0...6	6	Displayed precision - position of the decimal point.	
			0	000000
			1	00000.0
			2	0000.00
			3	000.000
			4	00.0000
			5	0.00000
			6	Automatic - the position of the decimal point is set for maximum resolution.
4025	0..8	0	Contents of the bottom line of the display	
			Value	Description
			0	Unit according to the selected unit (register 4026)
			1	Measuring value on the main input, without the mathematical operations and the individual characteristic, not averaged.
			2	Measuring value on the main input averaged using the moving window method and converted based on the selected mathematical function and the individual characteristics.

			3	Value additionally measured on the main input during the measurement of the main value selected according to the configuration of the main input type (e.g. a frequency in the period measurement).
			4	Measuring value on the additional input, without the mathematical operations and the individual characteristic, not averaged.
			5	Measuring value on the additional input averaged using the moving window method and converted based on the selected mathematical function and the individual characteristics.
			6	Value additionally measured on the additional input during the measurement of the main value selected according to the configuration of the main input type (e.g. a frequency in the period measurement).
			7	Current time
			8	Status of all inputs of the meter.
4026	0...56	0	Selection of the unit to be displayed in the lower line of the display on the main screen (see register 4025). See point 5.1.	
4027	0...9999	0	Access protection code to make changed in the configuration using the meter menu. It would be required to provide a code each time when entering the meter menu in case of entering a value higher than zero.	
4028	0, 1	0	Enable the individual characteristic for the main input.	
			Value	Description
			0	Individual characteristic disabled.
			1	Individual characteristic enabled.
4029	2...32	2	Number of points of main input individual characteristic.	
4030	0, 1	0	Enable the individual characteristic for the additional input.	
			Value	Description
			0	Individual characteristic disabled.
			1	Individual characteristic enabled.
4031	2...32	2	Number of points of additional input individual characteristic.	
Analog output				
4032	0...5	0	Analog output mode.	
			Value	Description
			0	Output disabled.
			1	Output in operating mode 4...20 mA.
			2	Output in operating mode 0...20 mA.
			3	Output in operating mode 0...10 V.
			4	Current output controlled manually.
5	Voltage output controlled manually.			
4033	0...8	0	Quantity controlling the analog output signal	
			Value	Description
			0	Measuring value at the main input, averaged and converted using the individual characteristic and the mathematical functions.
			1	Measuring value at the main input, averaged without conversion using the mathematical functions and the individual characteristic.
			2	Measuring value at the main input, without averaging and

				conversions.
			3	Value additionally measured on the main input (e.g. period during the frequency measurement).
			4	Measuring value at the additional input, averaged and converted using the individual characteristic and the mathematical functions.
			5	Measuring value at the additional input, averaged without conversion using the mathematical functions and the individual characteristic.
			6	Measuring value at the additional input, without averaging and conversions.
			7	Value additionally measured on the additional input (e.g. period during the frequency measurement).
			8	Current time.
RS-485				
4034	1...247	1	RS-485 – MODBUS network meter address	
4035	0...3	0	RS-485 – data transmission frame type (format)	
			Value	Frame type
			0	8N1
			1	8N2
			2	8O1
4036	0...8	2	RS-485 – baud rate.	
			Value	Baud rate [b/s]
			0	2400
			1	4800
			2	9600
			3	14400
			4	19200
			5	28800
			6	38400
			7	57600
8	115200			
4037	0, 1	0	RS-485 – Apply entered settings. Entering the value 1 changes immediately the settings and resets the register. If the RS-485 interface parameters have been modified without applying the change, new parameters will be applied after the meter is turned on again.	
Alarm 1				
4038	0...8	0	Value controlling the alarm. Significance of the settings as for the register 4033 (quantity controlling the analog output).	
4039	0...6	5	Alarm type (see section 5.4.3)	
			Value	Description
			0	n-on
			1	n-off
			2	on
			3	off
4	H-on – manually disabled			

			5	H-off – manually enabled
			6	REG – state controlled by the RS-485 interface
4040	0...900	0	Alarm activation delay in seconds.	
4041	0...900	0	Alarm deactivation delay in seconds.	
4042	0, 1	0	Alarm activation memory. Entering the value 1 activates the alarm event memory function.	
Alarm 2				
4043	0..8	0	Value controlling the alarm, as for the alarm no. 1.	
4044	0...6	5	Alarm type, as for the alarm no. 1.	
4045	0...900	0	Alarm activation delay in seconds.	
4046	0...900	0	Alarm deactivation delay in seconds.	
4047	0, 1	0	Alarm activation memory. Entering the value 1 activates the alarm event memory function.	
Alarm 3				
4048	0..8	0	Value controlling the alarm, as for the alarm no. 1.	
4049	0...6	5	Alarm type, as for the alarm no. 1.	
4050	0...900	0	Alarm activation delay in seconds.	
4051	0...900	0	Alarm deactivation delay in seconds.	
4052	0, 1	0	Alarm activation memory. Entering the value 1 activates the alarm event memory function.	
Alarm 4				
4053	0..8	0	Value controlling the alarm, as for the alarm no. 1.	
4054	0...6	5	Alarm type, as for the alarm no. 1.	
4055	0...900	0	Alarm activation delay in seconds.	
4056	0...900	0	Alarm deactivation delay in seconds.	
4057	0, 1	0	Alarm activation memory. Entering the value 1 activates the alarm event memory function.	
Clock – setting only. The registers store data of last entered time and date.				
4058	0..99	19	Real-time clock – year - value to set the current year.	
4059	1...12	8	Real-time clock – month - value to set the current month.	
4060	1...31	1	Real-time clock – day - value to set the current day.	
4061	0...23	12	Real-time clock – hours - value to set the current hours.	
4062	0...59	0	Real-time clock – minutes - value to set the current minutes.	
4063	0...59	0	Real-time clock – seconds - value to set the current seconds.	
4064	0, 1	0	Automatic change of DST and inversely Entering the value 1 enables the function of automatic change of DST and inversely.	
4065	0, 1	0	Apply entered time. Entering the value 1 sets the clock for the time and date defined in the registers 4058...4063. The register is reset after applying the changes.	
Alarms - Control				
4066	0, 1	0	Alarm 1 - alarm state control for the active alarm in REG mode. Entering the value 1 activates the alarm. Entering the value 0 deactivates the alarm.	
4067	0, 1	0	Alarm 2 - alarm state control for the active alarm in REG mode. Entering the value 1 activates the alarm. Entering the value 0 deactivates the alarm.	
4068	0, 1	0	Alarm 3 - alarm state control for the active alarm in REG mode. Entering the value 1 activates the alarm. Entering the value 0	

			deactivates the alarm.	
4069	0, 1	0	Alarm 4 - alarm state control for the active alarm in REG mode. Entering the value 1 activates the alarm. Entering the value 0 deactivates the alarm.	
Alarms - Deleting alarm memory				
4070	0, 1	0	Alarm 1 - delete alarm memory. Entering the value 1 deletes the alarm event memory.	
4071	0, 1	0	Alarm 2 - delete alarm memory. Entering the value 1 deletes the alarm event memory.	
4072	0, 1	0	Alarm 3 - delete alarm memory. Entering the value 1 deletes the alarm event memory.	
4073	0, 1	0	Alarm 4 - delete alarm memory. Entering the value 1 deletes the alarm event memory.	
Additional requests				
4074	0...15	0	Reset minimum / maximum of measuring value / measuring values. Reset request resets the minimum and maximum values, unless there is no measurement error. Then the reset will be completed after the error is cleared. The value from the register is retrieved and the register is cleared after the request is issued. The register is treated as bits, with each bit corresponding to reset of a different value.	
			Bit	Description
			0	Reset minimum value on the main input.
			1	Reset maximum value on the main input.
			2	Reset minimum value on the additional input.
3	Reset maximum value on the additional input.			
4075	0...3	0	Control of the main input counter - entering the appropriate command will execute it and reset the value in the register.	
			Value	Description
			0	Do nothing.
			1	Start the counter of the main input.
			2	Stop the counter of the main input.
3	Reset the counter of the main input.			
4076	0...3	0	Control of the additional input counter. Operation as for the main input (see register 4075).	
4077	0...3	0	Control of the counter connected to the input no. 3. Operation as for the main input (see register 4075).	
4078	0...3	0	Control of the counter connected to the input no. 4. Operation as for the main input (see register 4075).	
4079	0, 1	0	Restore default settings Entering 1 restores the default settings (default configuration) and resets this register.	

5.5.4.2 Registers 4200 – 4257

Readout only 16-bit registers.

Address	Description
System parameters	
4200	Device ID
4201	Software version - version number multiplied by the value 100.
4202	N32 meter type - code corresponding to the "O" character.

4203	Meter serial number - older 16 bits.	
4204	Meter serial number - younger 16 bits.	
4205	Meter calibration date - older 16 bits.	
4206	Meter calibration date - younger 16 bits.	
4207	Total meter operation time in seconds - older 16 bits.	
4208	Total meter operation time in seconds - younger 16 bits.	
Real Time Clock		
4209	Current date - year in YY format.	
4210	Current date - month.	
4211	Current date - day.	
4212	Current time - hour.	
4213	Current time - minutes.	
4214	Current time - seconds.	
4215	State of the internal time clock	
	Value	Description
	0	No clock errors.
	1	Lost time settings.
	2	Clock initialization error - faulty clock.
3	Clock setting error.	
Alarms - alarm event memory		
4216	Alarm 1: Value 1 - active mode to register the alarm event. Value zero - no alarm events registered.	
4217	Alarm 2: Value 1 - active mode to register the alarm event. Value zero - no alarm events registered.	
4218	Alarm 3: Value 1 - active mode to register the alarm event. Value zero - no alarm events registered.	
4219	Alarm 4: Value 1 - active mode to register the alarm event. Value zero - no alarm events registered.	
Counters - 64-bit content of the successive counters		
4220	The registers store 64-bit content of the main input counter corresponding to the counted number of pulses (time units) without the mathematical conversion, the register 4220 stores the highest 16 bits of the word and the register 4223 stores the lowest 16 bits of the word.	
4221		
4222		
4223		
4224	The registers store 64-bit content of the additional input counter corresponding to the counted number of pulses (time units) without the mathematical conversion, the register 4224 stores the highest 16 bits of the word and the register 4227 stores the lowest 16 bits of the word.	
4225		
4226		
4227		
4228	The registers store 64-bit content of the input no. 3 counter corresponding to the counted number of pulses, the register 4228 stores the highest 16 bits of the word and the register 4231 stores the lowest 16 bits of the word.	
4229		
4230		
4231		
4232	The registers store 64-bit content of the input no. 4 counter corresponding to the counted number of pulses, the register 4228 stores the highest 16 bits of the word and the register 4231 stores the lowest 16 bits of the word.	
4233		
4234		
4235		
Status bits - value 1 indicates the occurrence of a given event		
4236	Communication error with the internal data memory.	

4237	Corrupted configuration registers from register group 4000.
4238	Corrupted configuration registers from register group 7600.
4239	Corrupted calibration registers - no calibration.
4240	The meter is not calibrated.
4241	Communication error with the analog output module.
4242	Incorrectly configured individual characteristic of the main input.
4243	Incorrectly configured individual characteristic of the additional input.
4244	Loss time - not set RTC clock.
4245	Alarm 1 active.
4246	Alarm 2 active.
4247	Alarm 3 active.
4248	Alarm 4 active.
4249	Value of main input counter.
4250	Value of additional input counter.
4251	Value of input no. 3 counter.
4252	Value of input no. 4 counter.
4253	State of input I1A.
4254	State of input I1B.
4255	State of input I2.
4256	State of input I3.
4257	State of input I4.

5.5.4.3 Registers 7500 – 7521 and 7000 – 7043

The 32-bit and the corresponding 16-bit registers with measuring and calculated data. The address entered in the address field is for 32-bit float variables or in the second column for the values stored in two 16-bit registers, where the value stored in two registers is of float type.

Address (32-bit float registers)	Address (value in 2 16-bit registers)	Description
7500	7000	Device ID
7501	7002	Measuring value on the main input without the mathematical functions, averaging using the moving window method and without the individual characteristic.
7502	7004	Value additionally measured on the main input.
7503	7006	Measuring value on the main input without the conversion, but averaged using the moving window method.
7504	7008	Minimum value of the measured quantity on the main input (converted by the mathematical functions, individual characteristics and averaged).
7505	7010	Maximum value of the measured quantity on the main input (converted by the mathematical functions, individual characteristics and averaged).
7506	7012	Measuring value on the main input - measuring value and then averaged, converted by the mathematical functions and converted in accordance with the configuration of the individual characteristic.
7507	7014	Minimum value of measuring quantity on the main input registered during the averaging window (during the selected averaging period).

7508	7016	Maximum value of measuring quantity on the main input registered during the averaging window (during the selected averaging period).
7509	7018	Measuring value on the auxiliary input without the mathematical functions, averaging using the moving window method and without the individual characteristic.
7510	7020	Value additionally measured on the additional input.
7511	7022	Measuring value on the auxiliary input without the conversion, but averaged using the moving window method.
7512	7024	Minimum value of the measured quantity on the auxiliary input (converted by the mathematical functions, individual characteristics and averaged).
7513	7026	Maximum value of the measured quantity on the auxiliary input (converted by the mathematical functions, individual characteristics and averaged).
7514	7028	Measuring value on the auxiliary input - measuring value and then averaged, converted by the mathematical functions and converted in accordance with the configuration of the individual characteristic.
7515	7030	Minimum value of measuring quantity on the auxiliary input registered during the averaging window (during the selected averaging period).
7516	7032	Maximum value of measuring quantity on the auxiliary input registered during the averaging window (during the selected averaging period).
7517	7034	Content of input no. 3 counter.
7518	7036	Content of input no. 4 counter.
7519	7038	Voltage of the backup battery.
7520	7040	CPU temperature.
7521	7042	Current time in the form of hh.mmss.

5.5.4.4 Registers 7600 – 7744 and 7200 – 7489

The 32-bit and the corresponding 16-bit registers with the configuration parameters.

Address (32-bit float registers)	Address (value in 2 16-bit registers)	Permissible values	Default	Description
Minimum and maximum displayed value				
7600	7200	-99999...999999	-99999	Display narrowing lower threshold. If the value to be displayed is below the threshold, the lower limit symbol is displayed.
7601	7202	-99999...999999	999999	Display narrowing upper threshold. If the value to be displayed is above the threshold, the upper limit symbol is displayed.
Main and auxiliary input counter parameters				
7602	7204	-99999...999999	1	CONSt parameter for the main input defines the value by which the measurement result will be multiplied or divided.
7603	7206	-99999...999999	999999	AUtO parameter for the main input. The value to which the main input counter will count (for up counting) or the initial value of the counter (for down counting).
7604	7208	-99999...999999	1	CONSt parameter for the additional input defines the value by which the measurement result will be multiplied or divided.
7605	7210	-99999...999999	999999	AUtO parameter for the additional input. The value to which the main input counter will count (for up counting) or the initial value of the counter (for down counting).
Analog output				
7606	7212	-99999M...999999M	0	The quantity of the value controlling the analog output for which the output will have the minimum value (according to the output range).
7607	7214	-99999M...999999M	100	Quantity of value controlling the analog output for which

				the output will have the maximum value (according to the output range).
7608	7216	0...22	0	The value of the analog output signal for manual operation or during a measurement error at the input.
Alarms – alarm state change thresholds				
7609	7218	-99999...999999	10	Alarm 1 – alarm state change lower threshold.
7610	7220	-99999...999999	20	Alarm 1 – alarm state change upper threshold.
7611	7222	-99999...999999	10	Alarm 2 – alarm state change lower threshold.
7612	7224	-99999...999999	20	Alarm 2 – alarm state change upper threshold.
7613	7226	-99999...999999	10	Alarm 3 – alarm state change lower threshold.
7614	7228	-99999...999999	20	Alarm 3 – alarm state change upper threshold.
7615	7230	-99999...999999	10	Alarm 4 – alarm state change lower threshold.
7616	7232	-99999...999999	20	Alarm 4 – alarm state change upper threshold.
Points of main input individual characteristic. Xn - value of the measuring quantity for which Yn value will be displayed on the display Yn - displayed value for the measuring value Xn, where n - point number				
7617	7234	-99999...999999	0	X1
7618	7236	-99999...999999	0	Y1
7619	7238	-99999...999999	1	X2
7620	7240	-99999...999999	1	Y2
7621	7242	-99999...999999	2	X3
7622	7244	-99999...999999	2	Y3
7623	7246	-99999...999999	3	X4
7624	7248	-99999...999999	3	Y4
7625	7250	-99999...999999	4	X5
7626	7252	-99999...999999	4	Y5
7627	7254	-99999...999999	5	X6
7628	7256	-99999...999999	5	Y6
7629	7258	-99999...999999	6	X7
7630	7260	-99999...999999	6	Y7
7631	7262	-99999...999999	7	X8
7632	7264	-99999...999999	7	Y8
7633	7266	-99999...999999	8	X9
7634	7268	-99999...999999	8	Y9
7635	7270	-99999...999999	9	X10
7636	7272	-99999...999999	9	Y10
7637	7274	-99999...999999	10	X11
7638	7276	-99999...999999	10	Y11
7639	7278	-99999...999999	11	X12
7640	7280	-99999...999999	11	Y12
7641	7282	-99999...999999	12	X13
7642	7284	-99999...999999	12	Y13
7643	7286	-99999...999999	13	X14
7644	7288	-99999...999999	13	Y14
7645	7290	-99999...999999	14	X15









7646	7292	-99999...999999	14	Y15
7647	7294	-99999...999999	15	X16
7648	7296	-99999...999999	15	Y16
7649	7298	-99999...999999	16	X17
7650	7300	-99999...999999	16	Y17
7651	7302	-99999...999999	17	X18
7652	7304	-99999...999999	17	Y18
7653	7306	-99999...999999	18	X19
7654	7308	-99999...999999	18	Y19
7655	7310	-99999...999999	19	X20
7656	7312	-99999...999999	19	Y20
7657	7314	-99999...999999	20	X21
7658	7316	-99999...999999	20	Y21
7659	7318	-99999...999999	21	X22
7660	7320	-99999...999999	21	Y22
7661	7322	-99999...999999	22	X23
7662	7324	-99999...999999	22	Y23
7663	7326	-99999...999999	23	X24
7664	7328	-99999...999999	23	Y24
7665	7330	-99999...999999	24	X25
7666	7332	-99999...999999	24	Y25
7667	7334	-99999...999999	25	X26
7668	7336	-99999...999999	25	Y26
7669	7338	-99999...999999	26	X27
7670	7340	-99999...999999	26	Y27
7671	7342	-99999...999999	27	X28
7672	7344	-99999...999999	27	Y28
7673	7346	-99999...999999	28	X29
7674	7348	-99999...999999	28	Y29
7675	7350	-99999...999999	29	X30
7676	7352	-99999...999999	29	Y30
7677	7354	-99999...999999	30	X31
7678	7356	-99999...999999	30	Y31
7679	7358	-99999...999999	31	X32
7680	7360	-99999...999999	31	Y32
Points of additional input individual characteristic. Xn - value of the measuring quantity for which Yn value will be displayed on the display Yn - displayed value for the measuring value Xn, where n - point number				
7681	7362	-99999...999999	0	X1
7682	7364	-99999...999999	0	Y1
7683	7366	-99999...999999	1	X2
7684	7368	-99999...999999	1	Y2
7685	7370	-99999...999999	2	X3
7686	7372	-99999...999999	2	Y3

7687	7374	-99999...999999	3	X4
7688	7376	-99999...999999	3	Y4
7689	7378	-99999...999999	4	X5
7690	7380	-99999...999999	4	Y5
7691	7382	-99999...999999	5	X6
7692	7384	-99999...999999	5	Y6
7693	7386	-99999...999999	6	X7
7694	7388	-99999...999999	6	Y7
7695	7390	-99999...999999	7	X8
7696	7392	-99999...999999	7	Y8
7697	7394	-99999...999999	8	X9
7698	7396	-99999...999999	8	Y9
7699	7398	-99999...999999	9	X10
7700	7400	-99999...999999	9	Y10
7701	7402	-99999...999999	10	X11
7702	7404	-99999...999999	10	Y11
7703	7406	-99999...999999	11	X12
7704	7408	-99999...999999	11	Y12
7705	7410	-99999...999999	12	X13
7706	7412	-99999...999999	12	Y13
7707	7414	-99999...999999	13	X14
7708	7416	-99999...999999	13	Y14
7709	7418	-99999...999999	14	X15
7710	7420	-99999...999999	14	Y15
7711	7422	-99999...999999	15	X16
7712	7424	-99999...999999	15	Y16
7713	7426	-99999...999999	16	X17
7714	7428	-99999...999999	16	Y17
7715	7430	-99999...999999	17	X18
7716	7432	-99999...999999	17	Y18
7717	7434	-99999...999999	18	X19
7718	7436	-99999...999999	18	Y19
7719	7438	-99999...999999	19	X20
7720	7440	-99999...999999	19	Y20
7721	7442	-99999...999999	20	X21
7722	7444	-99999...999999	20	Y21
7723	7446	-99999...999999	21	X22
7724	7448	-99999...999999	21	Y22
7725	7450	-99999...999999	22	X23
7726	7452	-99999...999999	22	Y23
7727	7454	-99999...999999	23	X24
7728	7456	-99999...999999	23	Y24
7729	7458	-99999...999999	24	X25

7730	7460	-99999...999999	24	Y25
7731	7462	-99999...999999	25	X26
7732	7464	-99999...999999	25	Y26
7733	7466	-99999...999999	26	X27
7734	7468	-99999...999999	26	Y27
7735	7470	-99999...999999	27	X28
7736	7472	-99999...999999	27	Y28
7737	7474	-99999...999999	28	X29
7738	7476	-99999...999999	28	Y29
7739	7478	-99999...999999	29	X30
7740	7480	-99999...999999	29	Y30
7741	7482	-99999...999999	30	X31
7742	7484	-99999...999999	30	Y31
7743	7486	-99999...999999	31	X32
7744	7488	-99999...999999	31	Y32

6 Error codes

The N320 meters have several diagnostic functions and settings built-in that allow to limit the displaying. So the display may show and the status registers may store information about the diagnosed error, event or fault. Possible messages and their potential causes are listed below.

Message	Description
	Overflow of the lower value of the measuring range value or the programmed indication range.
	Overflow of the upper value of the measuring range value or the programmed indication range.
	It is not possible to display the measuring value in the selected resolution - the measurement result does not fit on the display. Lower the display resolution or select the mode of automatic position of the decimal point.
	Lost calibration. Please contact the technical support.
	Lost real time clock settings. The message is displayed only when turning the meter on. Time and date must be set. If the message still appears when turning the meter on after setting the time and date, please contact the Service Department because a backup battery may require to be replaced. This message can be ignored if the clock settings are not significant in a given application.
	Measurement module error. It is not possible to make a measurement, please contact the technical support.
	Configuration data memory and calibration memory error. It is not possible to use a meter, please contact the technical support.
	No communication with the analog output module. Please contact the Service Department.

7 Technical data

Measuring ranges

Input type	Indication range	Class, measurement error
Main input		
Pulse counter	-99999...999999	±1 pulse
Slow changing pulses counter	-99999...999999	±1 pulse
Period	0.00005...3600 [s] ¹	0.001 ²
Frequency	0.017...20,000 Hz ¹	0.001 ²
Rotation speed	0...999999	0.001 ²
Encoder	0...999999	±1 pulse
Pulse counter with frequency measurement	0...999999 0.017...20,000 Hz ¹	±1 pulse 0.01
Working time counter, Timer	0...999999	0.5 second a day
Current time		0.5 second a day
Additional input		
Pulse counter	-99999...999999	±1 pulse
Slow changing pulses counter	-99999...999999	±1 pulse
Period	0.00005...3600 [s] ¹	0.001 ²
Frequency	0.017...20,000 Hz ¹	0.001 ²
Rotation speed		0.001 ²
Working time counter, Timer		0.5 second a day
Current time		0.5 second a day

¹ The maximum measurement time (signal period duration) for frequency and period measurement is defined by SAVG setting, which also narrows the measuring range.

² The measurement error is defined as a percentage of the displayed value, but not less than the error resulting from the gating time of 30 ns, eg for the displayed value of 1000.00 Hz, the measurement error will be 0.01 Hz + 0.03 Hz.

Maximum frequency of the input signal is limited to 20 kHz. The minimum pulse duration t_{Hmin} and the pulse interval t_{Lmin} is defined as 25 μ s. The errors may occur in the measurements (loss of pulses, errors of the measuring value, etc.) if the signal does not meet the minimum duration.

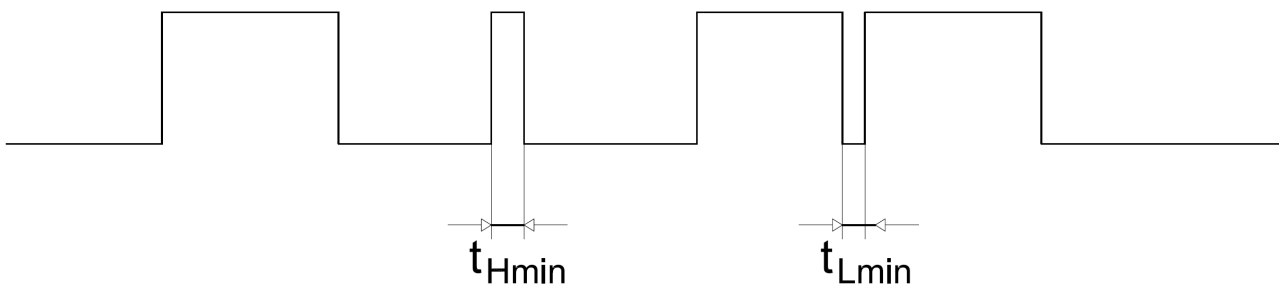

Parameters of measuring loops, binary inputs

Low level voltage (inactive input)	< 4 V
High level voltage (active input)	> 7 V
Current drawn by the input at 24 V	3.8 mA
Maximum continuous operating voltage of the binary input	30 V
Maximum operating voltage of the binary input at 50% duty cycle (signal frequency higher than 2 Hz)	40 V
Scanning frequency of the additional inputs I3 and I4	1000 Hz
Frequency of the control signals connected to the inputs I3 and I4	< 500 Hz

Additional measurement errors

Due to ambient temperature change	50% of class / 10 K
-----------------------------------	---------------------

RS485 interface

Galvanic separation	From all other signal connections
Protocol	MODBUS RTU
Supported protocol functions	3, 4, 6, 16, 17
Data frame type	8N1, 8N2, 8O1, 8E1
Baud rate [b/s]	2400, 4800, 9600, 14400, 19200, 28800, 38400, 57600, 115200

Alarm outputs:

- NO relay: 5 A / 250 V AC; 5 A / 30 V DC (listed current values are the maximum permissible values. Operation at maximum load significantly shortens lifespan of the relay).
- Three relays with a switching contact (option): 6 A / 250 V AC; 6 A / 30 V DC; 0.15 A / 250 V DC. Maximum switching current 10 A / 20 ms.

Analog output

Voltage output	
Rated range	0...10 V
Maximum output voltage	< 15 V
Minimum load resistance	500 Ω
Intrinsic error	0.1 % of range
Error due to temperature change	50% of intrinsic error value / 10 K
Current output	
Rated range	0...20 mA; 4...20 mA
Maximum output voltage	< 15 V
Maximum load resistance	500 Ω
Maximum current value	24 mA
Intrinsic error	0.1% of range
Error due to temperature change	50% of intrinsic error value / 10 K

Rated operating conditions

Supply voltage (depends on the version)	85...253 V AC (40...400 Hz), 90...300 V DC or 20...40 V AC (40...400 Hz), 20...60 V DC
Power Consumption	< 6 VA
Working temperature	-25...23...+55 °C
Storage temperature	-30...70 °C
Humidity	<95 % (no condensation)
Working position	any
Preheating time	15 minutes

Protection grade ensured

From the front	IP65
From the terminals side	IP10

Weight and dimensions

Meter weight	< 0.2 kg
Dimensions (see Fig. 3)	96 x 48 x 93 mm

Electromagnetic compatibility

Noise immunity:	acc. to EN 61000-6-2
Noise emission:	acc. to EN 61000-6-4

Safety requirements acc. to EN 61010-1

Circuit-to-circuit insulation:	basic
Installation category:	III
Pollution grade	2
Maximum phase-to-earth operating voltage:	50 V for the measurement circuits. 300 V for the circuits: supply, alarm. 50 V for the circuits: auxiliary supply, RS-485 interface, analog output
Altitude a.s.l.	< 2000 m

8 Ordering code

Panel meter N320 type	X	X	XXXXXXXX	X	X
Supply voltage					
85..253 V AC, 90...300 V DC	1				
20...40 V AC, 20...60 V DC	2				
Outputs / Interface					
1 relay output, RS-485		1			
4 relay outputs, RS-485		2			
4 relay outputs, RS-485, 1 analog output		3			
Version					
standard			0000000		
custom-made*			XXXXXXXX		
Language version					
Polish - English*				M	
Acceptance tests					
without extra requirements					0
with quality inspection certificate					1
with calibration certificate					2
acc. to customer's request*					X

* only after agreeing with a manufacturer.

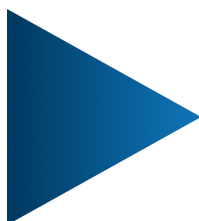

LUMEL S.A.

ul. Słubicka 4, 65-127 Zielona Góra, POLAND
tel. 68 45 75 100
www.lumel.com.pl

Technical support:

tel.: (+48 68) 45 75 143, 45 75 141, 45 75 144, 45 75 140
e-mail: export@lumel.com.pl

Export department:

tel.: (+48 68) 45 75 130, 45 75 131, 45 75 132
e-mail: export@lumel.com.pl

Calibration & Attestation:

e-mail: laboratorium@lumel.com.pl