

INSULATION METER
NT10

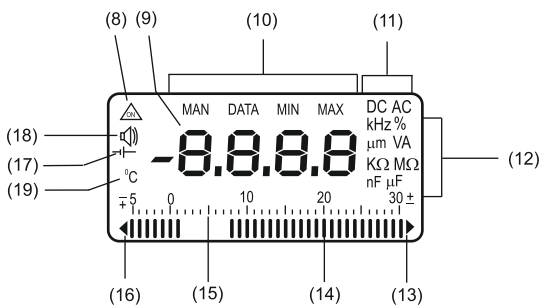

USER'S MANUAL

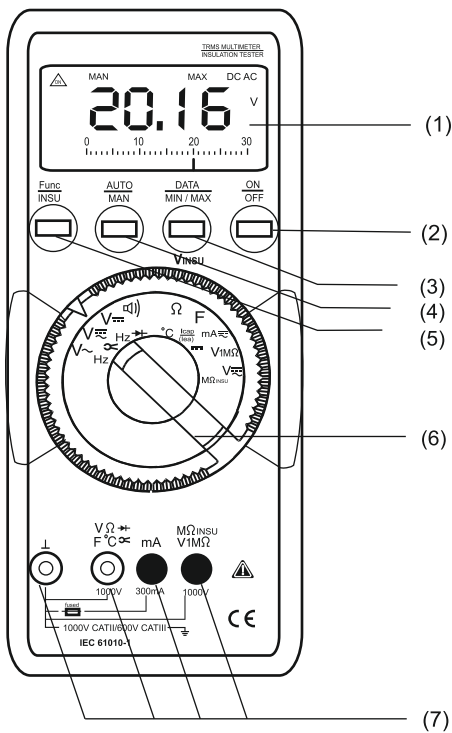



- | | |
|--|---|
| (1) Liquid crystal display | (10) Display for manual range selection, DATA hold and MIN/MAX storage. |
| (2) ON/OFF pushbutton | (11) Display for the selected function |
| (3) Pushbutton for data hold and MIN/MAX storage functions | (12) Display for the unit of measured quantity. |
| (4) Pushbutton for manual range selection | (13) Over range indication for positive analog range. |
| (5) Multi function pushbutton | (14) Pointer for analog indication. |
| (6) Function selector switch. | (15) Scale for analog indication |
| (7) Terminal sockets with automatic blocking system. | (16) Over range indication for negative analog range. |
| (8) Symbol for "CONTINUOUSLY ON" | (17) Low battery indication. |
| (9) Display for digits, decimal point and polarity. | (18) Buzzer indication |
| | (19) Display °C for temperature measurement range. |

Contents

Page

1. Introduction	2
2. Safety features and safety precautions.....	2
3. Switching the multimeter "ON".....	3
4. Function and range selection.....	4
4.1 Switching the DC current measuring ranges.....	4
4.2 Autoranging	4
4.3 Manual range selection.....	5
5. Liquid crystal display.....	5
5.1 Digital display	5
5.2 Analog indication	5
5.3 Backlit (optional)	6
6. "DATA " hold facility.....	6
7. Minimum value and maximum value "MIN/MAX" storage facility.....	6
8. Voltage measurement.....	7
9. Current measurement.....	9
9.1 AC current measurement with (clip-on) current transformers.....	11
10. Resistance measurement.....	11
11. Diode test and continuity test.....	13
12. Capacitance measurement	14
13. Equivalent leakage current measurement	14
14. Frequency measurement	15
15. Duty cycle measurement	15
16. Temperature measurement	16
17. Insulation resistance measurement	17
17.1 Before measurement	17
17.2 Selecting Test Voltage	17
17.3 Insulation Resistance measurement	17
17.4 After Insulation measurement	18
17.5 Evaluation of measurement values	18
18. Specifications.....	19
19. Maintenance.....	20
19.1 Battery.....	28
19.2 Fuses.....	28
19.3 Case.....	29

1. Introduction:

Thank you very much for selecting our multimeter. We are the leading manufacturer of Electrical and Electronics measuring instruments. These multimeters are manufactured as per IS 13875 and DIN 43751.

2. Safety features and safety precautions

You have chosen a multimeter which provides you a very high degree of safety. This meter is manufactured and tested in compliance with the safety standard IEC 61010-1:2001/ DIN EN61010 -1:2001 and IEC61557.

In case of incorrect use or careless handling, the safety of both user and multimeter is not assured.

For proper use and safe handling, it is absolutely necessary to read and understand the operating instructions before using the meter.

For your safety and for protection of the multimeter, this meter is fitted with an Automatic terminal Blocking System (ABS).

It is coupled with the function selector switch which blocks the Terminal sockets not necessary for measurement.

Please note the following safety precautions:

- The multimeter must be operated only by persons who understand the danger of shock hazards and are aware of the necessary safety precautions. Shock hazards exist wherever voltages of more than 30V (TRMS) are present.
- Do not work alone in shock hazardous environment while carrying out measurement.
- The maximum permissible voltage between terminal Socket (7) and ground is 1000 V.
- Take into account that unexpected voltages can occur on device under test (e.g. defective instrument). For example, capacitors may be charged to a dangerously high voltage.
- Verify that the test leads are in good condition, e.g. no cracked insulation, no open circuits in the leads or connectors.
- This multimeter must not be used for measurements on circuits with corona discharge (high voltage).
- Be particularly careful when measuring on HF circuits. Dangerous composite voltages may exist there.
- Measurements under moist environmental conditions are not Permitted.
- Do not overload the measuring ranges beyond their allowable capacities. Limit values are given in specifications Refer Chapter 18
- All current measuring ranges, are protected with fuse. The maximum permissible voltage of the measuring circuit (=nominal voltage of the fuse) is 1000 VAC/DC in "mA" ranges.

Meaning of the symbols on the device



Warning of a danger point
(Attention, refer to the user
manual)



Earth (ground) terminal.



Double or reinforced insulation

CAT II / III / IV

Instrument for over voltage
category II / III or IV



EU conformity mark.

Repair, replacement of parts:

When opening the meter, live parts may be exposed. The meter must be disconnected from the measuring circuit prior to opening its case for repair or replacement of parts. If repair cannot be avoided unless the meter is opened and live, this work must only be performed by a qualified person who understands the danger involved.

When it is realised that the safe operation is no longer possible, take the meter out of service and secure it against accidental use.

Safe operation may not be possible,

- when the meter shows obvious signs of damage,
- when the meter no longer functions correctly,
- after prolonged storage under adverse conditions,
- due to severe stress during transportation.

3. Switching the multimeter "ON"

Battery

We have already fitted your meter with a 1.5V x 6 (AAA size) batteries according to IEC 6 LR 03. It is ready for operation.

meter for the first time or after storage, refer to Section "19.1 Maintenance-Battery".

Switching the meter "ON"

- Press the "ON/OFF" pushbutton (2).
Switch-"ON" is acknowledged by a sound signal. As long as you keep the pushbutton pressed, all segments of the liquid crystal display (LCD) will appear. The LCD is shown on page 1.
After the pushbutton is released, the meter is ready for operation.

Note:

Electric discharges and high-frequency influence may cause incorrect information to be displayed and block the measuring process. Reset the meter by switching it OFF and ON again otherwise, check the battery connections.

Disconnect the meter from the measuring circuit before you open it, and see section "19.Maintenance"!

Automatic TURN - OFF

The meter turns off automatically, when the measured value remains constant (variations of the measured value $\leq \pm 2$ digits) for about 10 minutes and when neither a pushbutton nor the function selector switch is operated during that time. It remains ON, however, when a current measuring range is selected and a measured value >30 digits is displayed.

How to prevent automatic TURN-OFF

In order to prevent automatic "TURN OFF" select "CONTINUOUSLY ON" mode. For this, press yellow multi-function pushbutton (5) and the "ON/OFF" pushbutton (2) together. The function "CONTINUOUSLY ON" is shown on the LCD (1) by the symbol  (8).

Turning the multimeter OFF

Press the "ON/OFF" pushbutton (2).

4. Function and range selection

The function selector switch (6) is coupled with the Automatic terminal Blocking System (ABS) which allows access only to two correct sockets for each function. Prior to switching to the "mA" functions or from the "mA" functions, remove the test lead from the corresponding socket. When the test leads are plugged-in, the terminal blocking systems prevents accidental switching to nonpermissible functions.

4.1 Switching the DC current measuring ranges

300 μ A, 30 mA, 300 mA

The current measuring ranges mentioned above are not automatically selected when the meter is switched ON. The above ranges can only be selected manually with "AUTO/MAN" key!

Note:

- Automatic turn-OFF is inactive on all current measuring ranges when the measured value display exceeds 30 digits.
Set the function selector switch (6) to the desired position.

4.2 Autoranging

The multimeters feature autoranging for all measuring ranges with the exception of the 30 mV $\overline{\text{---}}$, 300 mV.

Autoranging is automatically selected after switching the Multimeter ON.

According to the measured quantity applied, the multimeter automatically selects the measuring range which gives the best resolution. When switching to frequency measurement and to ratio measurement, the previously selected voltage measuring range is maintained.

The meter switches automatically to :

the next higher range	at	\pm (3099 digits + 1 digit)
the next lower range	at	\pm (240/280 digits - 1 digit)
from the 300mA $\overline{\text{---}}$ to the 3mA $\overline{\text{---}}$ range	at	\pm (24 digits - 1 digit)

4.3 Manual range selection

You can switch OFF auto-ranging and select the ranges manually according to the table on the following page.

Manual mode is switched OFF when pushbutton AUTO/MAN is pressed (4) for approximately 1s, when the function selector switch (6) is operated, or when the meter is turned OFF and ON again.

When switching back to auto-ranging from 30 mV $\overline{\text{---}}$ or 300 mV $\overline{\text{---}}$ ranges, 3 V $\overline{\text{---}}$ range is automatically selected.

↓ AUTO/ MAN (4)	Function	Acknowledgement	
		Dis- play	Sound Signal
Short	Manual mode on : Used range is fixed	MAN (10)	1 x
Short	Switching sequence at: V $\overline{\text{---}}$: 3V \rightarrow 30V \rightarrow 300V \rightarrow 1000V \rightarrow 30mV \rightarrow 300mV \rightarrow 3V \rightarrow ... V $\overline{\text{---}}$: 3V \rightarrow 30V \rightarrow 300V \rightarrow 1000V \rightarrow 3V \rightarrow ... mA $\overline{\text{---}}$: 300 μ A \rightarrow 3mA \rightarrow 30mA \rightarrow 300mA \rightarrow 300 μ A mA $\overline{\text{---}}$: 3mA \rightarrow 300mA \rightarrow 3mA \rightarrow ... Ω : 30M Ω \rightarrow 30 Ω \rightarrow 300 Ω \rightarrow 3 k Ω \rightarrow 30 k Ω \rightarrow 300 k Ω \rightarrow 3 M Ω \rightarrow 30M Ω ... F: 30nF \rightarrow 300nF \rightarrow 3 μ F \rightarrow 30 μ F \rightarrow 30nF ... $\frac{I_{cap}}{(lea)}$: 2.3mA \rightarrow 22.57mA \rightarrow 107.7mA \rightarrow 121.7mA \rightarrow 2.3mA.. Hz: 300Hz \rightarrow 3kHz \rightarrow 30kHz \rightarrow 100kHz \rightarrow 300Hz ...	MAN (10)	1 x
Long	Return to autoranging	-	2 X

5. Liquid crystal display

5.1 Digital display

The digital display (9) shows the measured value with correct location of decimal point and sign. The selected measuring Unit (12) and the function (11) are simultaneously displayed. When measuring DC quantities, a minus sign appears in front of the digits, when the positive pole of the measured quantity is applied to the " \perp " input terminal. When upper range limit 3099 (on the r ange \rightarrow 1999), is exceeded then "OL" is displayed.

With V, A and Ω measurements, the digital display is updated two times per second.

5.2 Analog indication

The analog indication with pointer presentation gives the dynamic response of a moving-coil movement and is updated 20 times per second, when measuring V, A and Ω . Analog indication is of particular advantage when observing variations of measured values and for calibration procedures.

The analog indicator has its own polarity indication. When measuring DC quantities, the analog scale (15) has a negative range of 5 scale divisions so that variations of the measured values around "zero" can be observed exactly. When the measured value exceeds the range of indication, the left triangle (16) is shown before the polarity of the analog indicator switches over after approximately 0.7s. The over range indication on the measuring range ($>$ 3099 digits, on the range \rightarrow $>$ 1999) is shown by the right triangle (13).

5.3. Backlit

The instrument is provided with user selectable Back-lit for taking measurements in poor lighting conditions/ dark areas.

Switching the Backlit ON

By pressing "AUTO/MAN" and "DATA/MIN/MAX" keys simultaneously the Backlit can be switched ON.

Switching the Backlit OFF

By pressing "AUTO/MAN" and "DATA/MIN/MAX" keys simultaneously the Backlit can be switched OFF.

6. "DATA" hold facility

The DATA function allows to automatically hold the measured values. This is particularly useful, for instance, when connecting the probes to the measuring point requires full attention. When the measured value is applied and the "condition" according to the table shown below is met, the meter holds the measured value on the digital display and emits a sound signal. The probes can now be removed from the measuring point and the measured value on the digital display (9) can be read. When the measured value falls below the limit specified in the table, the meter is reactivated for a new storage.

The analog indication is not influenced by the DATA hold, The actual measured value can still be noted / read. Note that with a held digital display, the location of the decimal point is also held. With autoranging selected, the measuring range of the analog indicator is no longer known.

Function DATA	↓ DATA MIN/MAX (3)	Condition		Meter acknowledgement Display		
		Measuring Ranges	Limit of Measured Values (digits)	Meas. Value digital	DATA	Sound Signal
Activate	Short				flashes	1 x
Store		$V \approx \overset{2)}{\sim}$ $A \approx \overset{2)}{\sim}$ Ω $F, Hz, \% I_{cap}$ (I_{lea})	>280 >24 $< OL$ >280	dis- played	dis- played	1 x
Reactive ¹⁾		$V \approx \overset{2)}{\sim}$ $A \approx \overset{2)}{\sim}$ Ω $F, Hz, \% I_{cap}$ (I_{lea})	< 280 < 24 OL < 280	stored mea- sured value	flashes	
Reset	Long			Cleared	Cleared	2 x

- 1) Reactivated by falling below the specified limits of the measured value.
- 2) With the exception of the ranges 30 mV and 300 mV.

As long as the DATA hold function is active, manual range selection is not possible. The DATA hold function is switched OFF, when,

- ☛ The "DATA" push button(3) is pressed for approx. 1s. This is acknowledged by 2 sound signals.
- ☛ The function selector switch (6) is operated or
- ☛ The multimeter is turned OFF and ON again.

7. Minimum value and Maximum value "MIN/MAX" storage facility.

With the MIN/MAX function, you can hold the minimum and the maximum measured value which was applied to the input of the multimeter after activating MIN/MAX function. The most important application is the determination of the minimum and the maximum value for long-term monitoring of measured quantities. MIN/MAX does not influence the analog indication The actual measured value can still be noted/read.

Apply the measured quantity to the meter and select the measuring range prior to activating the MIN/MAX function.

With the function activated, you can select the measuring ranges only manually, if you switch to another range, the stored MIN/MAX values are cleared.

Function MIN/MAX	↓ DATA MIN/MAX (3)	Meas- uring ranges	Measured Values MIN and MAX	Meter acknowledgement		
				Display		Sound Signal
				Meas. Value digital	MIN MAX	
1. Activate and Store	2 x Short, 30 mV/ 300 mV and °C 1 x short	V ≈ Ω ≈ A ≈ F, Hz, % I _{cap} (lea) °C	Stored	actual measured value	MIN and MAX flash	1 x
2. Store and display	↓ short	V ≈ Ω ≈ A ≈ F, Hz, % I _{cap} (lea) °C	Storage Continued in the background, new MIN / MAX. values are displayed	stored MIN value	MIN	1 x
	↓ short			stored MAX value	MAX	1 x
3. Return to 1.	↓ Short	Same as 1.	Same as 1., Stored Values are not cleared	same as 1.	same as 1.	1 x
Reset	Long		Cleared	Cleared	Cleared	2 x

The MIN/MAX function is switched OFF, when the MIN/MAX pushbutton (3) is pressed for approximately 1s, or when the function selector switch (6) is operated, or when the meter is turned OFF and ON again.

8. Voltage measurement

- ☛ According to the voltage to be measured, set the function selector switch (6) to V ~, V --- or V ---.
- ☛ Connect the test leads as shown. The "⊥" socket should be connected to the lowest potential ground available.

Notes :

The 30 mV --- and 300 mV --- measuring ranges can only be selected manually with the "AUTO/MAN" pushbutton (4) !
On the 1000 V range, an intermittent sound signal warns you, when the measured value exceeds the upper range limit.

Caution :

Ensure current measuring range ("mA") is not selected for voltage measurement
When the cut-out rating of the fuses is exceeded because of incorrect operation
A dangerous situation exists!.

Zero adjustment on the 30 mV --- measuring range

- ☛ Connect the test leads to the meter and join the free ends.
After having selected the measuring range, briefly press the yellow multifunction pushbutton (5).
The meter acknowledges zero setting by a sound signal, the LCD shows "00.00" (+ 1 digit) and the decimal point flashes. The displayed voltage at the instant the pushbutton is pressed, is used as reference value (max ± 200 digits) it is automatically deducted from the values measured thereafter.

The zero adjustment is cleared when ;

- ☛ By pressing the yellow multifunction pushbutton (5) for a long time, clearance is acknowledged by the two sound signal.
- ☛ By switching the instrument OFF.

Voltage measurement

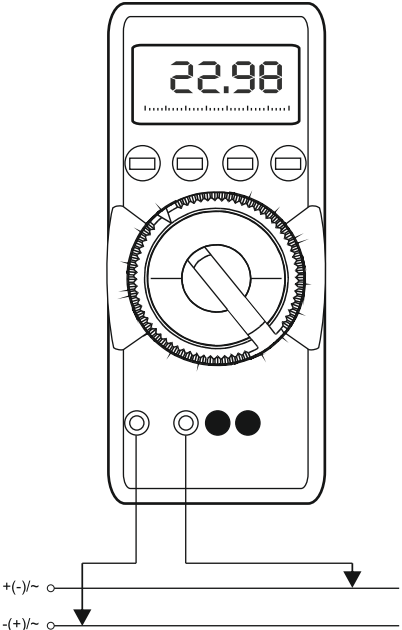

9. Current Measurement

- ✦ First disconnect the power supply to the circuit being measured and/or to the load, and discharge all capacitors within that circuit.
- ✦ Select the DC current measuring ranges as described in section 4.1
- ✦ With the function selector mA $\overleftrightarrow{=}$ for currents < 300 mA. When measuring current of unknown magnitude, select the highest measuring range first.
- ✦ Select the function corresponding to the measured quantity by briefly pressing the yellow multi-function pushbutton (5). Each time the pushbutton is pressed, alternate switching takes place between DC and (DC + AC).

The change-over is acknowledged by a sound signal. The symbols DC and AC (11) are displayed as per selected function on the LCD. When selecting a range with the function selector switch (6), the DC+AC function is always set by default. When pressing the yellow multi-function pushbutton (5) for a long time, the multimeter always switches back to DC + AC and acknowledges this by two sound signals.
- ✦ Connect the multimeter in series with the load, as shown. Ensure that the connections are tight (without contact resistance).

Notes on Current measurement :

- The multimeter must be used only in the power systems, where the current circuit is protected by a fuse or a circuit breaker of 2 A and when the nominal voltage of the system does not exceed 1000V AC/DC.
- Make the measuring circuit connections mechanically strong and secure so that they do not accidentally open. The conductor cross sections and connection points should be designed to avoid excessive heating.
- On the 300 mA an Intermittent sound signal warns you, when the Measured value exceeds the upper range limit.
- The current measuring ranges upto 300 mA are protected to a short

Current measurement

...300 mA

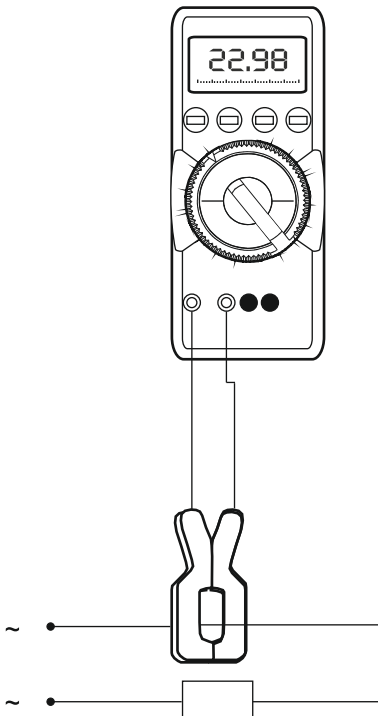
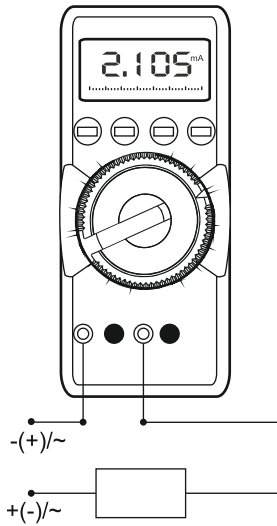

circuit current of 25 A by a fuse 1.6 A/1000V AC/DC in conjunction, with power diodes. The cut-out capacity of the fuse is 10kA at a rated voltage of 1000V AC/DC and ohmic load.

- ☛ A blown fuse is signalled on the LCD the instant a measured quantity having a voltage of more than 4 V is applied to the corresponding connection sockets. Then, the digital display (9) shows the word " FUSE"
- ☛ After a fuse has blown, eliminate the cause of the overload before using the meter again !
- ☛ Replacement of the fuses is described in section „19.Maintenance”.

9.1 AC current measurement with (clip-on) current transformer(∞)

- ☛ Current to voltage clamp with ratio 10 mA : 1mV is used to measure the current upto 300 A AC with this function
- ☛ Set rotary knob at position V(DC+ AC) .Press multifunction (Yellow) key until a sound beep is heard. This will enter “measurement with clip-on transformer” mode.
- ☛ Connect Clamp Output probes to “ \perp ” and “ ∞ ” input terminal of this meter
- ☛ It has two ranges i.e. 30.00 A and 300.0A. Measurement is possible with both auto ranging and manual ranging.

10. Resistance measurement

- ☛ Verify that the device under test is electrically dead. External voltages would falsify the measured result!
- ☛ Set the function selector switch (6) to “ Ω ”.
- ☛ Connect the device under test as shown.

Resistance measurement

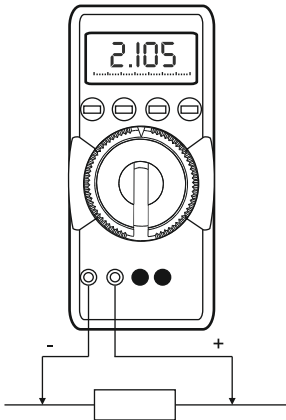

Diode Test

Forward direction

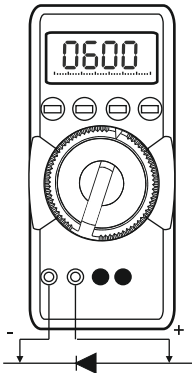

Reverse direction

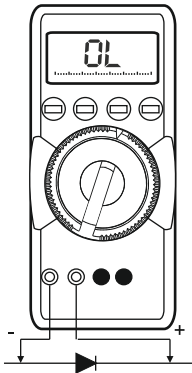

Continuity Test

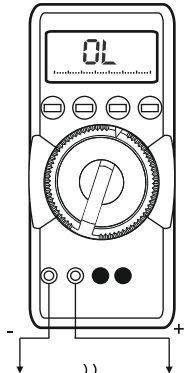
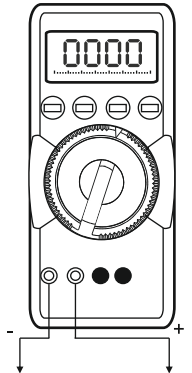

Zero adjustment on the 30 Ω measuring range

When measuring small resistance values on the 30 Ω range, you can eliminate the resistance of the leads and contact resistance by zero adjustment.

- Connect the test leads to the multimeter and join the free ends.
- Briefly press the yellow multi-function pushbutton (5). The meter acknowledges zero adjustment by a sound signal, the LCD shows "00.00" (+1digit) and the decimal point flashes. The resistance measured at the instant the pushbutton is pressed is used as reference value (max.200 digits) It is automatically deducted from the values measured thereafter. Zero adjustment can be cleared.
- By pressing the yellow multifunction pushbutton (5) for a long time and is acknowledged by two sound signals.
- By switching the multimeter OFF.

11. Diode test and continuity test

- Verify that the device under test is electrically dead. External voltages would falsify the measured results!
- Set the function selector switch (6) to " \rightarrow)) " "
- connect the device under test as shown.

Forward direction and/or short circuit:

The multimeter displays the forward voltage in Volts. As long as the voltage drop does not exceed the maximum display value of 1.999V, you can also test several series-connected elements or reference diodes with small reference voltage.

Reverse direction or open circuit:

The multimeter indicates overrange "OL"

Note:

Resistors and semiconductor junction in parallel with the diode falsify the measured results!

Diode test and continuity test with buzzer

With the "buzzer" function selected, the meter emits a continuous sound signal on the range 0...approx. 0.7 V.

To switch the Diode Test ON:

- Briefly press the yellow multi-function pushbutton (5).
- The multimeter acknowledges turn-ON with a sound signal. At the same time, the symbol \rightarrow)) (18) disappears from the LCD.

To switch the Diode Test OFF

- Briefly press the yellow multi-function pushbutton (5) again.
- The multimeter acknowledges turn-OFF with a sound signal. The symbol \rightarrow)) (18) appears on the LCD.

When selecting the function "Diode test and continuity test" with the function selector switch (6), the buzzer is always switched ON.. Repeated brief pressing of the multifunction pushbutton (5) alternately switches the buzzer off and on. When pressing the push button for a long time, the buzzer is always switched ON this is acknowledged by the buzzer sounding twice.

12.Capacitance measurement

- Verify that the device under test is electrically dead. External voltages would falsify the measured results!
- Set the function selector switch (6) to "F"
- Connect the (discharged !) device under test to the " ⊥ " and " F " sockets via test lead.

Notes:

Connect polarised capacitors with the " — " pole to the " ⊥ " socket. Resistors and semiconductor junctions in parallel with the capacitor falsify the measured results!

Zero adjustment on the 30 nF measuring range

When measuring small capacitance values on the 30 nF range, the internal resistance of the multimeter and the capacitance of the leads can be eliminated by zero adjustment.

- Connect the test leads to the meter without device under test.
- Briefly press the yellow multi-function pushbutton (5).
The meter acknowledges zero adjustment by a sound signal, by displaying "00.00" (+1digit) on the LCD and by a flashing decimal point. The capacitance measured at the instant the pushbutton is pressed is used as reference value (max.200digits). It is automatically deduced from the values measured thereafter.

The zero adjustment can be cleared

- By pressing the yellow multi-function pushbutton (5) for a long time, clearance is acknowledged by the two sound signal.
- By switching the multimeter off.

13. Equivalant leakage current measurement.

- Select 'F' function using rotary knob.
- Select manual ranging mode by pressing AUTO/MAN key
- Select 300nF or above range, press multifunction key (Yellow) key, then "Equivalent leakage current" mode is entered.
- Connect the measuring probes to the " ⊥"and " F" Sockets. This measures equivalent leakage current as below

$$I(\text{cap})/(\text{lea}) = \frac{(230 \text{ V} + 6\%)}{\sqrt{(4000000 + (1/(314 * C))^2)}}$$

14. Frequency measurement

Frequency measurement is possible on all voltage measuring ranges in AC and DC modes.

- Set the function selector switch (6) to $V \sim$ or $V \overline{\sim}$.
- Connections are made the same way as for voltage measurement, See foot note (8) on page 21.
- Briefly press the yellow multi-function pushbutton (5)
The multimeter switches to frequency measurement. The frequency is displayed on the LCD.

See section "19. Specifications" for the lowest measurable frequencies and the maximum permissible voltages.

Changing over between voltage, frequency and duty cycle measurement

Repeated brief pressing of the yellow multi-function switch (5) changes the measuring functions in the following order:

Voltage → frequency → duty cycle → voltage

From frequency or duty cycle measurement, directly switching back to voltage measurement is possible.

- by pressing the yellow multi-function pushbutton (5) for a long time. The meter acknowledges this by two sound signals. The voltage measuring range last selected is maintained.
- by operating the function selector switch (6).

15. Duty cycle measurement

With duty cycle measurement, we can determine the ratio of pulse duration to cycle time of recurring square-wave signals.

- Set the function selector switch (6) to $V \overline{\sim}$ or $V \sim$.
- Connections are made in the same way as for voltage measurement (See foot note 8) on page 23.

Briefly press the yellow multi-function pushbutton (5) twice.

The meter switches to duty cycle measurement. The duty cycle-that is the percentage pulse duration of a signal-is displayed on the LCD in %

- That is:
$$\text{Duty cycle (\%)} = \frac{\text{Pulse duration}}{\text{Cycle duration}} \times 100$$

Notes :

The applied frequency must remain constant during the duty cycle measurement. Change -over between voltage, frequency and duty cycle factor measurement is done as described in the preceding section.

16. Temperature measurement

The meter allows you to measure temperature with Pt100 and Pt1000 temperature sensors in the range from - 200 (- 100) °C...+850 °C

- ☛ Set the function selector switch (6) to “Ω”
- ☛ Connect the sensor to the two unblocked terminals.
- ☛ Briefly press the yellow multifunction pushbutton (5).
The multimeter switches to temperature measurement, it automatically detects the connected sensor (Pt100 to Pt1000) and shows the measured temperature in °C on the digital display.

Notes:

It is not possible to switch over to temperature measurement when the 30Ω resistance range is selected.

Sensor lead resistance up to 50 Ω

Lead resistance of sensors up to 50 ohms can be compensated as follows:

- ☛ Briefly press the yellow multi-function pushbutton (5) again.
The LCD now displays the resistance value which the multimeter automatically considers after selecting the temperature measuring range. We can recognise that this is the resistance correction value on the temperature measuring range. The “°C” character is simultaneously shown on the display.
- ☛ You can set the lead resistance correction value as follows:
Press the DATA--MIN/MAX pushbutton (3) to increment the value, or the AUTO/MAN pushbutton (4) to decrement the value. Each time the pushbutton is briefly pressed, the value changes by one digit.
- ☛ Briefly press the yellow multi-function pushbutton (5) again.
The LCD displays the measured temperature. The flashing decimal point shows you that we have entered a correction value for the lead resistance. The correction value is retained as long as multimeter is switched on.
- ☛ Each time the yellow multi-function pushbutton (5) is briefly pressed, the display changes between measured temperature and correction value of the lead resistance.

We can exit the temperature measurement function

- by pressing the yellow multi-function switch (5) longer, this is confirmed by the two sound signals.
- by changing the function selector switch.

Note:

For the lead resistance, the actual value measured on the digital multimeter should be taken as correction value and not any specified value.

17. Insulation resistance measurement

17.1 Before measurement.

⚠ CAUTION !!!

Insulation resistance of only 'voltage free objects' can be measured. Do not touch measuring probes.

- ⇒ Select the V1MΩ function using rotary switch
- ⇒ Connect the measuring probes to "1" and V1MΩ" input terminals. This function provides way to measure interference voltage. It also provides discharge path of 1Mohm to charge present on measuring objects.
- ⇒ Turn the rotary switch to "MΩINSU" when device under measurement is voltage free.
- ⇒ This position by default reads interference voltage. If this voltage is >50 V, insulation resistance measurement is disabled.



High Voltage

Do not touch the conductive ends of the test probes after insulation measurement has been activated at the instrument. A current with a value of 2.5 mA (limited by instrument) may flow over your body, and although this is not life threatening, the electric shock is distinctly perceptible. If you are taking measurement at capacitive DUT, for example a cable, it may be charged with as much as 1000 V, depending upon the selected nominal voltage. Touching the DUT may be life threatening.

17.2 Selecting Test Voltage: 50V or 100V or 250V or 500V or 1000V.

- ⇒ If VINSU key is briefly activated, currently selected test voltage is displayed.
- ⇒ Default values is 500 V. To select other value press and hold VINSU key until other voltage is displayed. This is confirmed with a sound beep signal.

17.3 Insulation resistance measurement:

- ⇒ Press and hold multifunction (yellow) key until display has stabilized. Insulation measurement is stopped when multifunction key is released.
- ⇒ An insulation resistance of less than 1MΩ with a test voltage of 500 V, or less than 2MΩ with a test voltage of 1000 V is indicated with an acoustic signal.
- ⇒ Automatic measuring range selection is active for insulation resistance measurement. There is no provision for the manual selection of measuring range.

⚠ NOTE !!!

The instrument batteries are rapidly depleted during insulation resistance measurement. Only press and hold the multifunction key as long as is necessary to take the reading. Continuous measurement as described below should only be performed if absolutely necessary. Use only Alkaline manganese batteries in accordance with IEC6 LR03.

Continuous Measurement

- ⇒ Activation: Press and hold multifunction (yellow) key and simultaneously press AUTO/MAN key until a sound beep is heard.

17.4 After Insulation measurement:

- ⇒ Voltage displayed after measurement is the voltage present on the device under test (DUT) due to conductor capacitance.
- ⇒ Discharge the device under test (DUT) by turning the function selector switch to "V1MΩ".
- ⇒ Contact with DUT must be maintained. Reduction of voltage can be observed directly on LCD.

⚠ CAUTION !!!

Do not disconnect DUT until voltage has dropped below 25V.

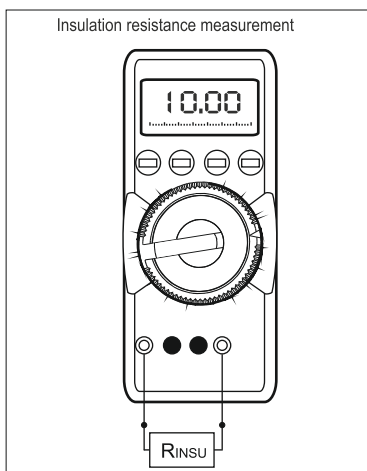

17.5 Evaluation of Measurement Values:

In order to assure that insulation resistance does not violate lower limit values, the instrument's intrinsic and influence errors must be taken into consideration.

The minimum values of insulation resistance can be determined by the following table, which must be displayed under consideration of maximum operating error for this meter (under nominal conditions of use) in order to assure that the required limit values are not violated.

Limit value in MΩ	Min.Display in MΩ
0.1	0.11
0.2	0.22
0.5	0.55
1	1.1
2	2.2
5	5.5
10	11
20	22
50	55
100	110
200	220
500	550
1000	1100
2000	2200

18. Specifications

Measurement Function	Measuring Range	Resolution	Input impedance
V $\overline{\dots}$	30.00 mV	10 μ V	> 10 G Ω // < 40 pF
	300.0 mV	100 μ V	> 10 G Ω // < 40 pF
	3.000 V	1 mV	11 M Ω // < 40 pF
	30.00 V	10 mV	10 M Ω // < 40 pF
	300.0 V	100 mV	10 M Ω // < 40 pF
	1000 V	1 V	10 M Ω // < 40 pF
V \sim	3.000 V ¹⁾	1mV	11 M Ω // < 40 pF
	30.00 V ¹⁾	10mV	10 M Ω // < 40 pF
	300.0 V ¹⁾	100 mV	10 M Ω // < 40 pF
	1000 V ¹⁾	1V	10 M Ω // < 40 pF
V $\overline{\sim}$	3.000 V ¹⁾	1 mV	11 M Ω // < 40 pF
	30.00 V ¹⁾	10 mV	10 M Ω // < 40 pF
	300.0 V ¹⁾	100 mV	10 M Ω // < 40 pF
	1000 V ¹⁾	1 V	10 M Ω // < 40 pF
			Voltage drop approx.
A $\overline{\dots}$	300.0 μ A	100 nA	15 mV
	3.000 mA	1 μ A	150 mV
	30.00 mA	10 μ A	650 mV
	300.0 mA	100 μ A	1V
A \sim ∞	30.00 A ²⁾	10 mA	-
	300.0 A ²⁾	100 mA	-
A $\overline{\sim}$	3.000 mA ¹⁾	1 μ A	150 mV
	300.0 mA ¹⁾	100 μ A	1V
			No load voltage
Ω	30.00 Ω	10 m Ω	max.3.2 V
	300.0 Ω	100 m Ω	max.3.2 V
	3.000 k Ω	1 Ω	max.1.25 V
	30.00 k Ω	10 Ω	max.1.25 V
	300.0 k Ω	100 Ω	max.1.25 V
	3.000M Ω	1 k Ω	max.1.25 V
	30.00M Ω	10 k Ω	max.1.25 V
\rightarrow	2.000 V	1 mV	max.3.2 V

1) TRMS measurement

3) At 0 $^{\circ}$...+40 $^{\circ}$ C

4) With zero adjustment, without zero adjustment + 35 digits

		Intrinsic error of digital display ± (...% of rdg. + ... digits) at reference conditions	Overload capacity 3)	
			Overload Value	Overload duration
		0.5 + 3 ⁴⁾	1000 V	Continuously
		0.5 + 3		
		0.25 + 1		
		0.25 + 1		
		0.25 + 1		
		0.35 + 1		
		1.0 + 3 (> 10 Digit)	DC	
		1.0 + 3 (> 10 Digit)	AC eff/rms sine wave	
		0.5 + 5 (> 10 Digit)	0.36 A	5)
		0.5 + 2		
		0.5 + 5 (>10 Digit)		
		0.5 + 5		
		0.5 + 5		5)
		0.5 + 5		
		1.5 + 4 (> 10 D)	12A	10min
		1.5 + 4 (> 10 D)		
		0.5 + 3 ⁴⁾	1000 V	Max 10 S
		0.5 + 3		
		0.4 + 1		
		0.4 + 1		
		0.4 + 1		
		0.6 + 1		
		2.0 + 1		
		0.25 + 1		

5) Continuously

6) 12 A 5 min, 16 A 30 s

Measurement Function	Measuring Range		Resolution	Discharge Resistance	$U_{0 \max}$
F		30.00 nF	10 pF	250 k Ω	2.5 V
		300.0 nF	100 pF	250 k Ω	2.5 V
		3.000 μ F	1 nF	25 k Ω	2.5 V
		30.00 μ F	10 nF	25 k Ω	2.5 V
I _{cap} (I _{ea})		2.300 mA	10 pF	250 k	2.5 V
		22.57 mA	100 pF	250 k	2.5 V
		107.7 mA	1 nF	25 k	2.5 V
		121.7 mA	10 nF	25 k	2.5 V
				$f_{\min} V \sim$	$f_{\min} V \sim$
Hz		3000 Hz	0.1 Hz	1 Hz	45 Hz
		3.000 kHz	1 Hz	1 Hz	45 Hz
		30.00 kHz	10 Hz	10 Hz	45 Hz
		100.0 kHz	100 Hz	100 Hz	100 Hz
%		2.0...98.0%	0.1 °C %	2 Hz	-
°C	pt 100	-200.0... + 200.0 °C	0.1 °C	-	-
		+ 200.0... + 850.0 °C	0.1 °C	-	-
	pt 1000	- 100.0... + 200.0 °C	0.1 °C	-	-
		+ 200.0... + 850.0 °C	0.1 °C	-	-

3) At 0...+40°C

4) With zero adjustment; without zero adjustment + 50 digits.

	Intrinsic error of digital display $\pm(\dots\% \text{ of reading.} + \dots \text{ digits})$ at reference conditions	Overload Capacity ³⁾	
		Overload value	Overload duration
	1.0 + 3 ⁴⁾	1000 V DC / AC eff / rms sine	Max 10 S
	1.0 + 3		
	1.0 + 3		
	3.0 + 3		
	1.0 + 3 ⁴⁾	1000 V DC / AC eff / rms sine	Max 10 S
	1.0 + 3		
	1.0 + 3		
	3.0 + 3		
	0.5 + 1 ⁷⁾	≤ 3 kHz; 1000 V ≤ 30 kHz; 300V ≤ 100 kHz 30 V	continuously
	2Hz... 1 kHz ± 5 Digit ⁸⁾ 1kHz ...10 kHz; ± 5 Digit/kHz ⁸⁾		
	2 Kelvin + 5 Digit ⁹⁾	1000 V	Max 10 S
	1.0 + 5 ⁹⁾	DC	
	2 Kelvin + 2 Digit ⁹⁾	AC eff/rms sine	
	1.0 + 2 ⁹⁾		

7) Range 3 V \cong :U_E = 1.5 V eff/rms.. 100 V eff/rms

30 V \cong : U_E = 15 V eff/rms.. 300 V eff/rms

300V \cong :U_E = 150 V eff/rms.. 1000 V eff/rms

8) On the range 3V \cong , square-wave signal positive on one side 5 ... 15 V,
f = const., not 163.84 Hz or integral multiple.

9) Without sensor.

Reference conditions

Ambient temperature :	+ 23 ⁰ C \pm 2 K
Relative humidity :	45% ... 55 % RH
Frequency of measured quantity	45Hz ...65 Hz
Waveform of the measured quantity	sinusoidal
Battery voltage	8 V \pm 0.1 V

Influence Quantities and Variations

Influence quantity	Range of influence	Measured quantity/ Measuring range	Variation ¹⁾ ± (...% of rdg. + ... digits)
Temperature	0°C + 21°C and + 25°C... + 40°C	30/300 mV $\overline{\text{---}}$	1.0 + 3
		3... 300 V $\overline{\text{---}}$	0.15 + 1
		1000 V $\overline{\text{---}}$	0.2 + 1
		V \sim	0.4 + 2
		300 $\mu\text{A}^{2)}$... 300 mA $\overline{\text{---}}$	0.5 + 1
		A $\overline{\text{---}}$	0.75 + 3
		30 $\Omega^{2)}$	0.15 + 2
		300 Ω	0.25 + 2
		3K Ω - 3M Ω	0.15 + 1
		30 M Ω	1.0 + 1
		30 nF ²⁾ - 3 μF	0.5 + 2
		30 μF	2.0 + 2
		Hz	0.5 + 1
		%	± 5 Digit
		-200 ... + 200 °C	0.5K+2
		+ 200 ... + 850 °C	0.5+2
M Ω INSU	0.25+2		
Frequency of the measured quantity	15 Hz ... < 30 Hz	3 ... 1000 V \sim	1.0 + 3
	30 Hz... < 45 Hz		0.5 + 3
	> 65 Hz... 400 Hz		2.0 + 3
	400 Hz... 1 kHz	3 ... 300 V \sim	3.0 + 3
		1000 V \sim	3.0 + 7
	15 Hz... < 30 Hz	A $\overline{\text{---}}$	1.0 + 3
	30 Hz ... < 45 Hz		0.5 + 3
> 65 Hz... 1 kHz	3.0 + 3		
Wave form of the measured quantity ³⁾	Crest. factor CF	V \sim ⁴⁾ , A $\overline{\text{---}}$ ⁴⁾	± 1 % of rdg.
			± 3 % of rdg.
<p>The permissible crest factor CF of the AC quantity to be measured is a function of the displayed value :</p> <div style="display: flex; justify-content: space-around;"> <div style="text-align: center;"> <p>Voltage measurement</p> </div> <div style="text-align: center;"> <p>Current measurement</p> </div> </div>			

Influence quantity	Range of Influence	Measured quantity/ Measuring range	Variation
Battery voltage	--- 5) ... < 7.9 V > 8.1 V ... 10.0V	V ---	± 2 Digit
		V \sim	± 4 Digit
		A ---	± 4 Digit
		A \sim	± 6 Digit
		30 Ω / 300 Ω / $^{\circ}\text{C}$	± 4 Digit
		3 k Ω --- 30 M Ω , M Ω INSU	± 3 Digit
		nF, μF , $\frac{\text{Icap}}{(\text{lea})}$	± 1 Digit
		Hz	± 1 Digit
	%	± 1 Digit	
Relative humidity	75 %	V \simeq , ∞	1 x intrinsic error
	3 days	A \simeq	
	Meter off	Ω	
		F, $\frac{\text{Icap}}{(\text{lea})}$	
		Hz	
		$^{\circ}\text{C}$	
DATA	-	%	± 1 Digit
MIN/MAX	-	V \simeq , A \simeq , ∞	± 2 Digit

- 1) With temperature : Error data apply per 10 K change in temperature.
With frequency : Error data apply to a display from 300 digits onwards.
- 2) With zero adjustment.
- 3) With unknown waveform (crest factor CF > 2), measure with manual range selection.
- 4) With the exception of sinusoidal waveform.
- 5) After the " --- " symbol is displayed.

Influence quantity	Range of Influence	Measuring ranges	Attenuation
Common mode interference voltage	Noise quantity max. 1000 V \sim	V ---	> 120 dB
	Noise quantity max. 1000 V \sim 50 Hz, 60 Hz sinusoidal	3V \sim , 30 V \sim 300 V \sim	> 70 dB
		1000 V \sim	> 60 dB
Normal mode interference voltage	Noise quantity V \sim value of the measuring range at a time max. 1000 V \sim , 50 Hz, 60 Hz. sinusoidal	V ---	> 50 dB
	Noise quantity max. 1000 V \sim	V \sim	> 110 dB

Display

Liquid crystal display section (65 mm x 30 mm) with analog indication and digital display and with display of the unit of measured quantity, function and various special functions.

Analog :

Indication	LCD scale with pointer
Scale length	55 mm on V $\overline{\text{---}}$ and A $\overline{\text{---}}$, 47 mm on all other ranges
Graduation	$\overline{\text{---}}$ 5...0... ± 30 with 35 scale divisions on $\overline{\text{---}}$, 0...30 with 30 scale divisions on all other ranges
Polarity indication	with automatic change-over
Overrange indication	by triangle (13)
Sampling rate	20 readings/s, on Ω ; 10 readings/s

Digital:

Display/Height of numer.	7-segment numerals/15mm
Number of digits	3 ^{3/4} digit \triangleq 3100 counts
Over range	"OL" is displayed.
Polarity indication	"- " sign is displayed, when the positive pole is at " \perp "
Sampling rate	2 reading/s, on Ω and °C: 1 reading/s

Power supply

Battery	1.5V X 6 (AAA size) alkaline-manganese cell according to IEC 6 LR 03.
---------	---

Lifespan	Without Backlit ON, using alkaline-manganese cell: approx. 600 hours on Vdc , Adc approx. 240 hours on Vac , Aac approx. 800 measurements for M Ω INSU @ 1000V approx. 2400 measurements, for M Ω INSU @ 50V, 100V,250V,500V. When operating with interface: times x 0.7
----------	--

Battery test	automatic display of the " --- " symbol, when the battery voltage drops below approx. 7 V.
--------------	---

EMC

Emission	Electromagnetic compatibility EN 61326 : 2002 Class B
Immunity	EN 61326 : 2002 IEC 61000-4-2 8 kV atmosphere discharge 4 kV contact discharge IEC 61000-4-3 : 3 V/m

Fuses

Fuse for upto 300mA ranges

FF (UR) 1.6 A / 1000V AC/DC; 6.3mm X 32mm; rating 10kA with 1000VAC/DC and ohmic load; in conjunction with power diodes, protects all current measuring ranges upto 300mA.

Response time (after manual range selection)

Measured quantity/ measuring range	Response time		Transient response for step function of the measured quantity
	of analog indication	of digital display	
V $\overline{\text{---}}$, V \sim , A $\overline{\text{---}}$, A \sim	0.7 s	1.5 s	from 0 to 80 % of upper range limit
30 Ω ... 3 M Ω	1.5 s	2 s	from 0 to 50 % of upper range limit
30 M Ω	4s	5 s	
\rightarrow	0.7 s	1.5 s	
nF μ F, $^{\circ}$ C		max. 1...3 s	from 0 to 50 % of upper range limit
300 Hz, 3 kHz		max. 2 s	
30, 100 kHz		max. 0.7 s	
% (1 Hz)		max. 9 s	
% (\geq 10Hz)		max. 2.5 s	

Interface

Type RS232C, serial, as per DIN 19241
 Data transmission Optically with infrared light through the case
 Baud rate 8192 bits/s

Ambient conditions

Functional temperature range $-10^{\circ}\text{C} \dots + 50^{\circ}\text{C}$
 Storage temperature range $-25^{\circ}\text{C} \dots + 70^{\circ}\text{C}$ without batteries
 Climatic class 2z/-10/50/70/75 % with reference to VDI/VDE 3540
 Altitude up to 2000 m

Mechanical configuration

Protection type IP 50, for the connection sockets IP 20
 according to DIN VDE 0470 Part 1 /EN 60529
 Dimensions 84 mm x 195 mm x 35 mm
 Weight 350 g approx., including battery

19. Maintenance

Caution

Disconnect the meter from the measuring circuit before you open it to replace the battery or the fuse!

19.1. Battery

Prior to initial start-up, or after storage of multimeter, verify that the batteries of multimeter does not leak. Repeat this check in regular short intervals. If the battery leaks, completely remove the battery electrolyte carefully with a moist cloth and install a new battery before you operate multimeter again.

When the symbol " --- " (17) appears on the LCD (1) replace the battery as soon as possible. Measurement can be done, but a reduced measuring accuracy must be taken into account.

The multimeter operates with a 1.5 V x 6 batteries according to IEC6 LR03.

Replacing the battery

- Place the multimeter on its face, loosen the two screws on the rear and remove the lower part of the case, lifting it from the bottom. The lower and the upper part of the case are fixed together at the top on the front by means of wedges.
- Remove all six batteries from the battery holder.
- Place six new batteries into battery holder with correct polarities.
- Replace the lower part of the case. Start at the top on the front and take care that the wedges are properly engaged at this point.
- Tighten the lower part with the two screws.
Please destroy the batteries in an environment friendly way.

19.2. Fuses

A blown fuse is signalled on the LCD display the instant a measured quantity having a voltage of more than 4 V is applied to the corresponding connection sockets.

Then, the digital display (9) shows "FUZE"

The 1.6 A protects all other current measuring ranges. All other measuring ranges continue to function.

When a fuse blows, first eliminate the cause of the overload using the multimeter again !

Fuse replacement

- Open the multimeter same as for battery replacement
- Remove the blown fuse, e.g. with the aid of a probe, and replace it with a new one.

Permissible types

-- for current measuring ranges up to 300 mA:

FF (UR) 1.6 A / 1000 V AC/DC ; (10 KA) ; 6.3 mm x 32 mm

Caution :

Absolutely verify that only the specified fuse is installed!

If a fuse of other cut-out capacity, other nominal current or other switching capacity is used, a dangerous situation exists, and there is danger of damaging protective diodes, resistors or other components.

The shorting of the fuse holder is not permissible.

19.3. Case

Special maintenance of the case is not required. Take care that the surface between the connection sockets is clean. For cleaning take a moist cloth. Avoid scrubbing.



LUMEL S.A.

ul. Słubicka 4, 65-127 Zielona Góra, POLAND

tel.: +48 68 45 75 100

www.lumel.com.pl

Export department:

tel.: (+48 68) 45 75 130, 45 75 132

fax.: (+48 68) 32 54 091

e-mail: export@lumel.com.pl

Technical support:

tel.: (+48 68) 45 75 143, 45 75 141, 45 75 144, 45 75 140