

# LUMEL

## SCREEN RECORDER

# KD6



## SERVICE MANUAL

## Contents

<b>1</b>	<b>Name and designation of the product</b> .....	<b>3</b>
<b>2</b>	<b>Recorder set</b> .....	<b>3</b>
<b>3</b>	<b>Basic requirements, user safety</b> .....	<b>4</b>
<b>4</b>	<b>Installation</b> .....	<b>4</b>
<b>5</b>	<b>Device description</b> .....	<b>5</b>
5.1	Mechanical design. ....	6
5.2	Basic modules.....	7
5.3	Diagram of connections between logical channels and inputs / outputs .....	9
<b>6</b>	<b>Recorder programming</b> .....	<b>9</b>
6.1	Recorder start-up.....	9
6.2	Language selection.....	10
6.3	Recorder front panel .....	10
6.3.1	Information bar .....	11
6.3.2	Navigation bar .....	13
6.4	Data panels.....	13
6.5	Configuration of KD6 parameters.....	14
6.5.1	General settings of the recorder .....	14
6.5.2	Inputs .....	15
6.5.3	Outputs:.....	17
6.5.4	Logical channels.....	18
6.5.5	Groups .....	20
6.5.6	Functions.....	22
	Mathematical functions.....	22
	Scaling functions .....	23
	Alarm function .....	23
6.5.7	Modbus Slave.....	27
6.5.8	Modbus Master / Slave.....	28
6.5.9	Ethernet.....	30
6.5.10	Security .....	32
6.5.11	Information .....	34
<b>7</b>	<b>Archiving measured values</b> .....	<b>35</b>
7.1	Internal memory.....	35
7.2	Creating a file archive .....	35
	Fig.30 Folders structure in the file archive .....	35
7.3	Building archive files .....	36
	Fig.31 Sample archive file with data .....	36
7.4	Archive download.....	37
<b>8</b>	<b>Serial interfaces</b> .....	<b>37</b>
8.1	RS485 interface - list of parameters.....	37
8.2	Examples of register reading and recording .....	37
	Readout of a single register (code 06h).....	39
	Recording to n-registers (code 10h) .....	39
8.3	Connecting the 10/100-Base-T interface.....	40
8.3.1	Web server.....	41
8.3.2	FTP server.....	42
8.3.3	Modbus TCP/IP .....	44
<b>9</b>	<b>Map of the KD6 recorder registers</b> .....	<b>45</b>
<b>10</b>	<b>Technical data</b> .....	<b>79</b>
<b>11</b>	<b>Ordering Code</b> .....	<b>84</b>

### 1 Name and designation of the product

The KD6 recorder is an advanced multi-channel device that allows to measure and display parameters in many channels simultaneously. It is an ideal solution for applications where several different physical quantities represent the state of the monitored object. This device can work autonomously or cooperate with external measuring and executive modules.

### 2 Recorder set

The set includes:

- |                                   |   |
|-----------------------------------|---|
| 1. KD6 recorder                   | 1 pc.                                   |
| 2. seal                           | 1 pc.                                   |
| 3. holder for mounting in a board | 1 set. (4 pcs.)                         |
| 4. screw set                      | 1 set (quantity depends on the version) |



1.

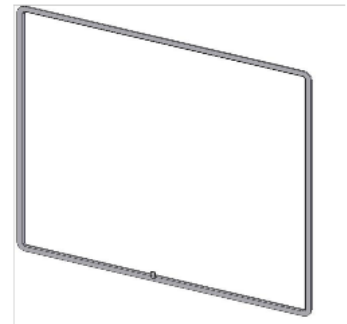

2.

4.

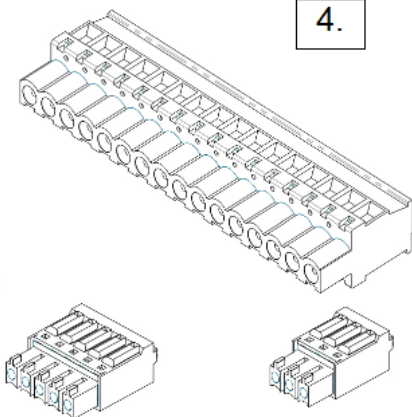

3.

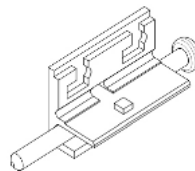

Fig.1 Recorder set

### 3 Basic requirements, user safety

In terms of operational safety, the recorder meets the requirements of the PN-EN 61010-1 standard. Safety Notes:

- The recorder should be installed and connected by qualified personnel. All available protection requirements must be considered.
- All pins should be inserted into the appropriate connectors on the device, even if they are not used for any connections.
- Before switching the recorder on, the correctness of connections shall be verified.
- Before removing the recorder housing, supply must be switched off and measuring circuits disconnected.
- Removal of the recorder housing during the warranty period voids its warranty.
- The recorder meets the requirements for electromagnetic compatibility in an industrial environment.
- There should be a switch or a circuit breaker in the building's installation, located near the device, easily accessible for the operator and appropriately marked.

### 4 Installation

The recorder is designed to be mounted in the board with the use of holders as shown in Fig. 1. The recorder housing is made of a self-extinguishing plastic.

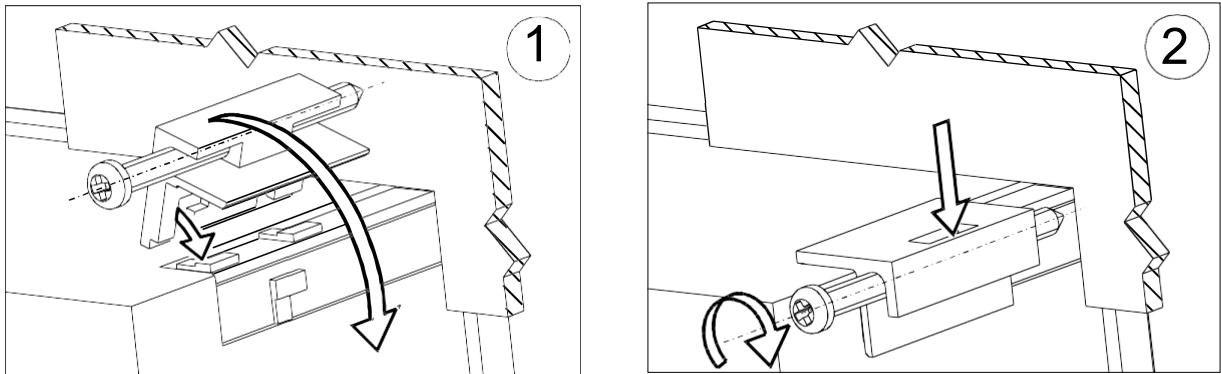

**Fig.2 Recorder mounting**

Housing dimensions 96 x 96 x 77 mm, mounting hole dimensions 92.5 x 92.5 mm. Outside the recorder, there are screw strips and self-locking ones which enable the connection of external wires with a cross-section of 2.5 mm<sup>2</sup>.

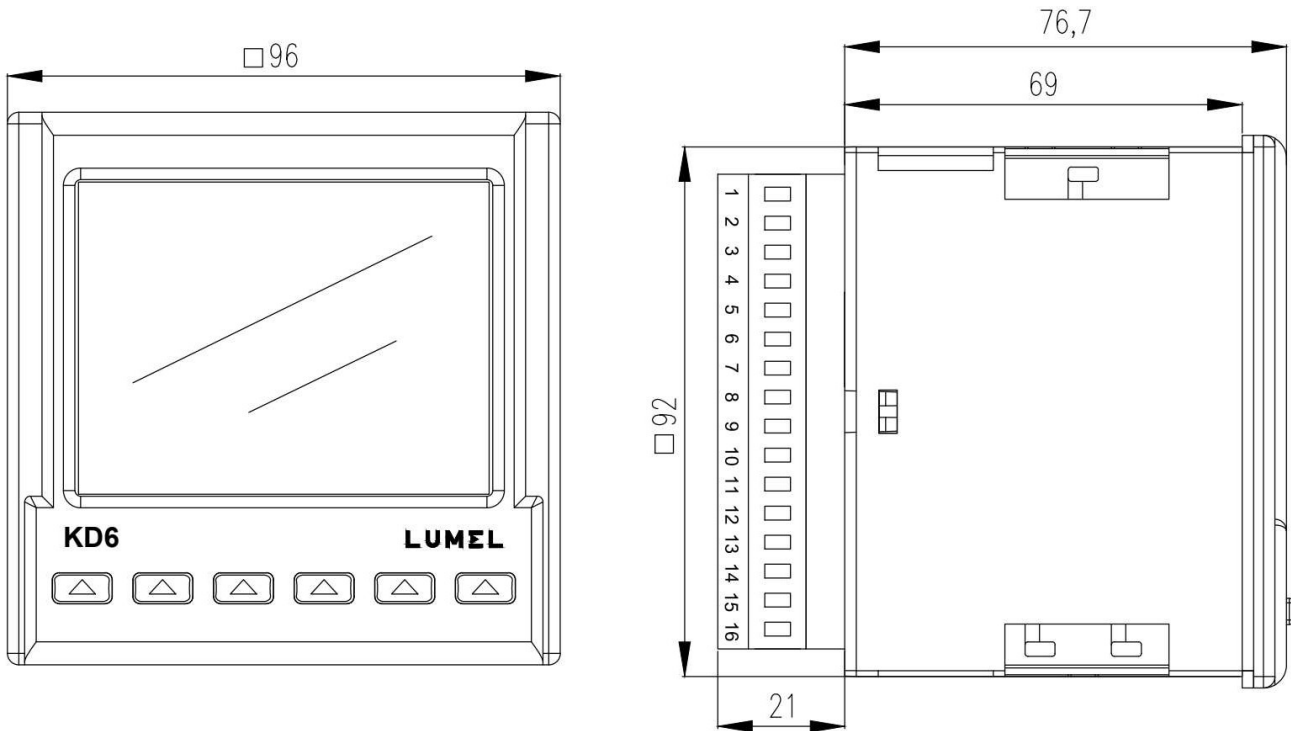

Fig.3 Overall dimensions figure of the KD6 recorder

### 5 Device description

KD6 has been designed as a modular device consisting of a power module (Z slot), communication module and optional input and output I / O modules (X and Y slot). The standard (basic) version of the recorder includes a power module, a display with buttons and a communication module.

The power module also includes an RS485 slave interface, 24 V / 30 mA object power supply, 2 x digital (voltage) inputs and 2 x relay outputs.

The communication module includes Ethernet, USB Host and RS485 master.

Functional features of the KD6 recorder:

- 3.5 "TFT colour graphic screen with a resolution of 320 x 240 pixels
- Ethernet 10/100 BASE-T, RJ45 socket, web server, ftp server, Modbus TCP / IP server, DHCP client
- USB Host

Recorder features:

- 60 logical channels,
- 10 logical groups being a combination of up to 6 logical channels,
- independent recording for each group (interval, recording trigger mode),
- alarm functions,
- mathematical functions,
- scaling functions,
- Modbus Master: 10 devices with 10 registers.

Data sources for logical channels:

- from internal measuring modules (binary inputs / outputs, analogue inputs / outputs),
- from remote devices connected to the recorder via the RS-485 Modbus Master interface,
- from mathematical, alarm and rescaling functions.

- Logical channels as a data source for:
- mathematical, alarm and rescaling functions,
  - logical groups
  - outputs (hardware relays),
  - analogue outputs.

- Presentation of data from logical channels on the display:
- as numerical values,
  - horizontal or vertical line and bar charts,
  - analogue indicators.

- Data recording
- 8GB internal memory,
  - as CSV or binary files.

- Downloading Recorded Data:
- USB HOST 2.0
  - FTP

## 5.1 Mechanical design.

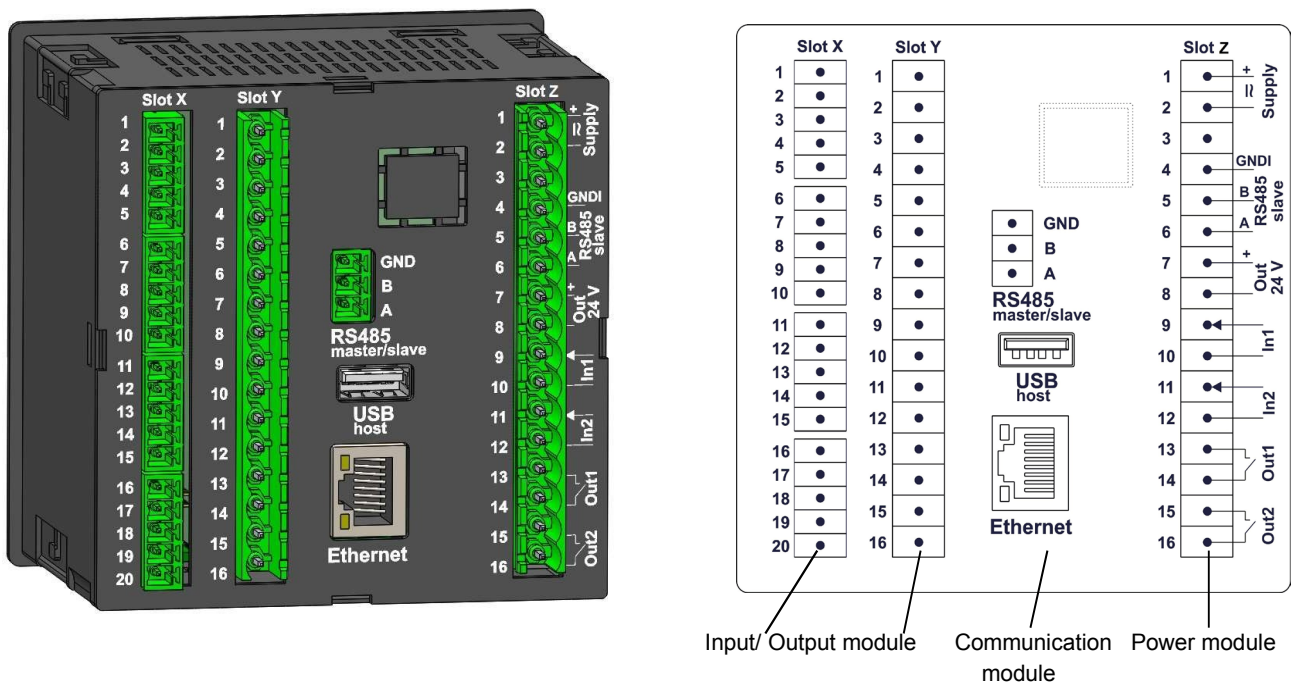

Fig.4 View of the recorder's rear plate

Input / output (I / O) modules are mounted in two slots X and Y.  
 Depending on the recorder execution code, the appearance of the X and Y slots of the rear panel in Fig. 4 may be different.

### 5.2 Basic modules.

Input / output (I / O) modules mounted in X / Y slots:

- a) 6 x relay output module ( Out1..Out6 ),
- b) 4 x relay output module ( Out1..Out4 ) + 4 x binary inputs separated from each other (In1..In4),
- c) 4 x analog output module ( Out1..Out4 ) + 4 x binary inputs with common ground ( In1..In4 ),
- d) 4 x programmable measuring inputs module ( In1..In4 ),

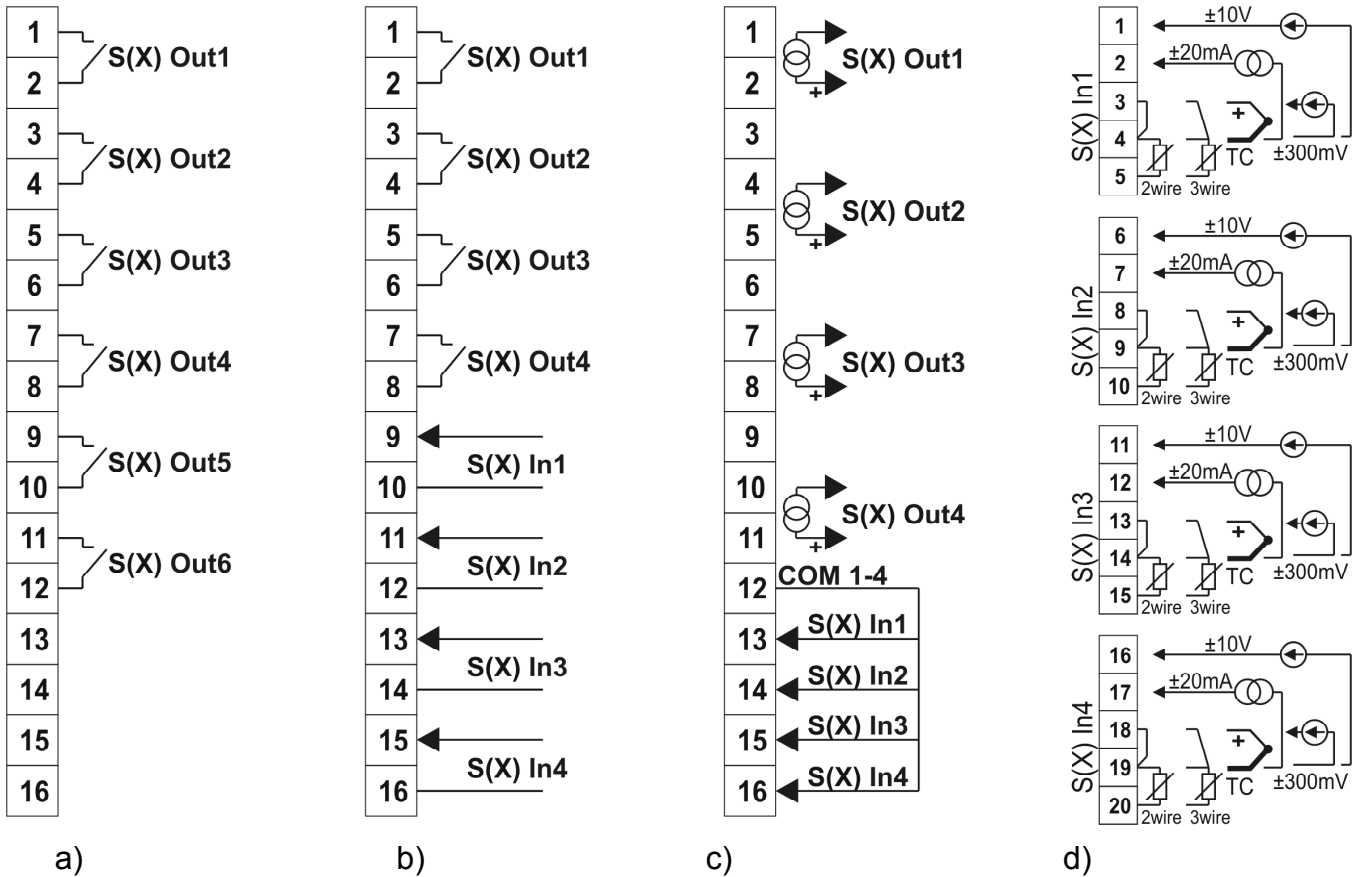
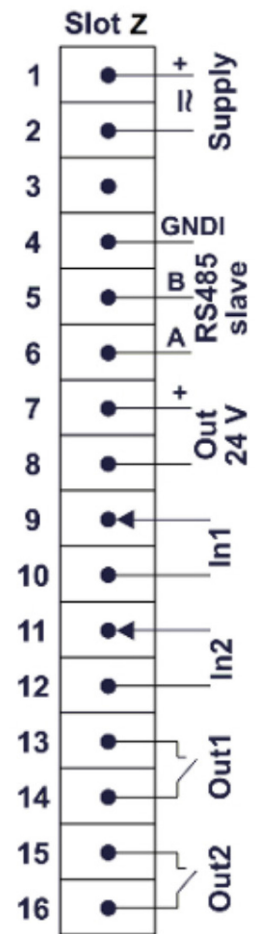

Fig.5 I / O module pin-outs description (for slot X)

Power module mounted in the Z slot:

- supply of the recorder supply (terminals 1,2)
- RS-485 slave communication interface (terminals 4-6)
- object power supply Out 24V (terminals 7,8)
- two binary inputs In1, In2 (terminals 9-12)
- two relay outputs Out1, Out2 (terminals 13-16)





### 5.3 Diagram of connections between logical channels and inputs / outputs

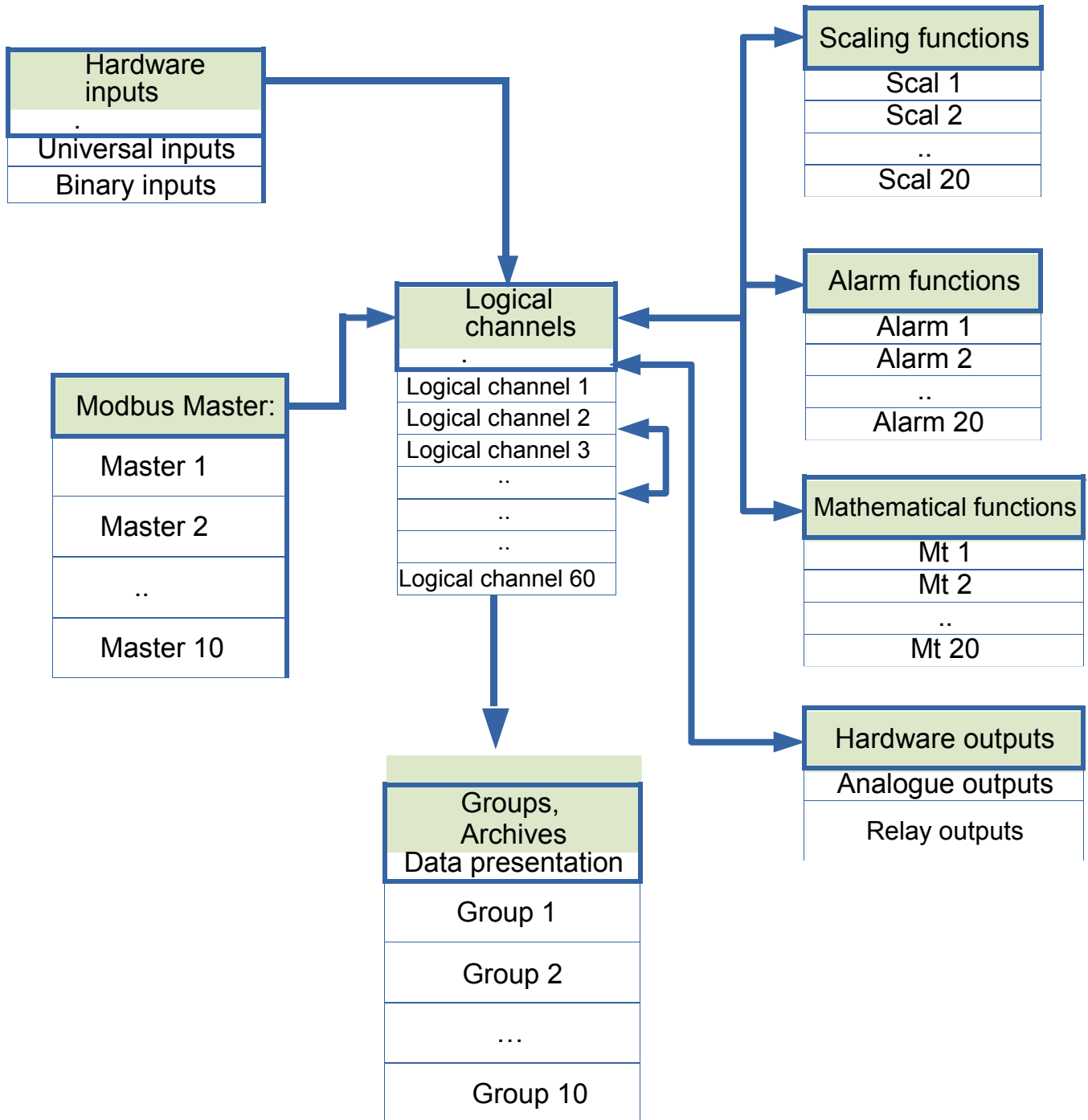

Fig.6. Diagram of connections between logical channels and inputs / outputs

## 6 Recorder programming

### 6.1 Recorder start-up

After switching the power on, the recorder displays the manufacturer’s logo, recorder name, input / output (I / O) modules mounted in the X / Y slots, the current software version, MAC address and recorder number. Then, the data visualization screen which was displayed at



the last disconnection of the recorder from the network appears.



Fig.7 The recorder screen after turning on the power

## 6.2 Language selection

The factory setting is English. To select a different language, press the Menu button and hold it for about 10 seconds. The language selection menu will then appear.



Use the buttons  or  to select the language, and then confirm by pressing the OK button.

## 6.3 Recorder front panel



Fig.8 KD 6 recorder front panel

The recorder has 6 buttons and a colour graphic screen.

Values of measured parameters are displayed in measuring groups selected by consecutive pressing of the buttons  (subsequent group) or  (previous group).

A maximum of any 6 values / logical channels / displayed simultaneously on the screen constitute a group. Defining of group is described in the **Groups** mode.

At the top of the screen there is an information bar (see section 6.3.1) informing the user about his work state on an ongoing basis.

The recorder buttons can be used for various functions. A description of the button functions can be found in the navigation bar at the bottom of the screen (see section 6.3.2). No description means that the button is inactive at the moment.

### 6.3.1 Information bar

The information bar at the top of the screen shows the state of the file archive memory, the archiving state, the symbol of connecting an external memory to the USB Host port, the symbol of transferring files from the file archive memory to an external memory connected to the USB Host port, symbol of Ethernet connection, indicators of receiving and transmitting data with the use of the RS485 link, date and real time clock.

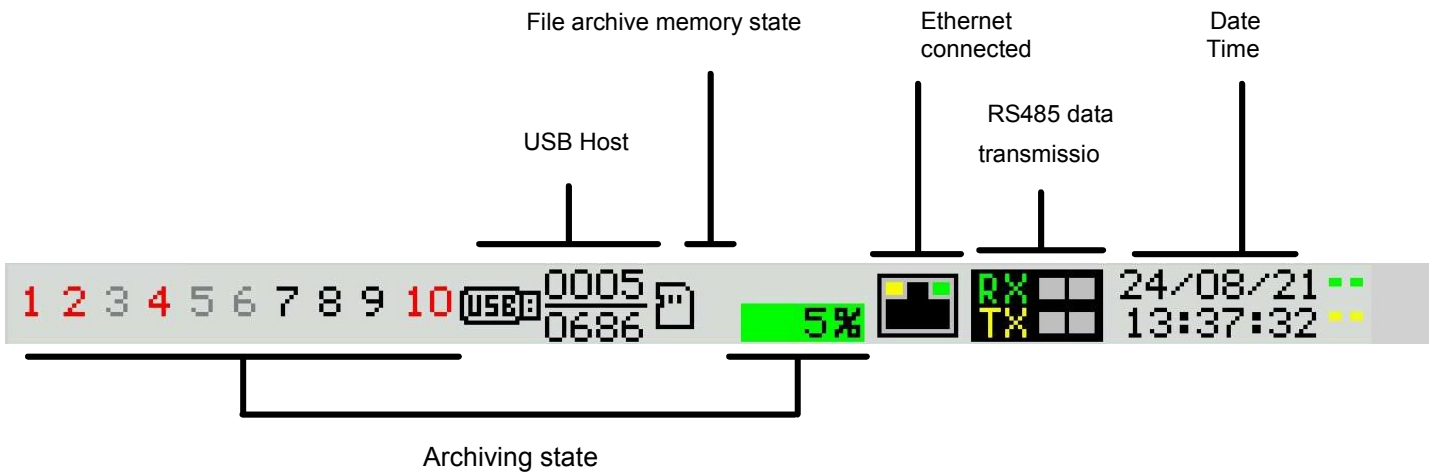











Fig. 9 Information bar







Symbol	Icon colour	Notes
	Black - archive memory installed correctly	
	Black - out of archive memory Red - Invalid file system on the card	
	Copying from internal memory to file archive memory. The percentage of use of the file archive memory is blinking blue and the percentage of copying progress is displayed.	
	Current archiving state: Black - archiving in the group enabled, waiting for the archiving condition to be met. Red - the archiving condition has been met and records are being saved. Grey - group archiving disabled.	Numbers indicate the archiving group
	Filling up the file archive memory in percentage	
	Green background	Value in the range 0 ... 70%
	Orange background	File archive over 70% full. It is recommended to delete unnecessary files via FTP or upload them to an external memory connected to the USB Host port.
	Red background	Less than 7% of free space in the file archive memory is left. Time until the file archive is completely full - approx. 14 days at 1 sec. interval. Delete unnecessary files via FTP immediately.  When the file archive is full to 95%, the overwrite mode starts and the oldest archive files are deleted during further archiving and new archive files are created.

	Percentage of progress when copying the archive	
	Blue pulsating background	Copying from internal memory to file archive is in progress
	File transfer to an external memory connected to the USB Host port	 - 5 files were transferred  - total number of files to be transferred
	Symbol indicating the connecting of an external memory to the USB Host port	

### 6.3.2 Navigation bar

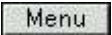
At the bottom of the screen, there is a navigation bar describing the functions of the buttons that allow the user to configure the recorder parameters, change the display mode, and change the displayed group.

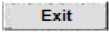
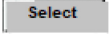
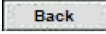
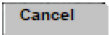
Button functions:

- |   |   |
|---|---|
|    | - Switching between the presented groups of logical channels.   |
|    | - Switching between different presentations of displayed data values in the current group.  |
|    | - Pressing the Menu button brings up the main menu selection window. This window allows to enter the Device Configuration, File Management menu and display the Device Info window. |
|    | - Navigation buttons in the option selection menu.  |
|    | - Displacement buttons. They allow to move the cursor in the edited text.   |
|   | - Exit the main menu.   |
|  | - Confirming the selection, introducing changes and exiting the edition window.   |
|  | - Leaving the current submenu.  |
|  | - Cancellation, no changes made.  |
|  | - Switching between graphs in data presentation mode as line graphs.  |

### 6.4 Data panels

The displayed data can be presented in several modes:

- numerical values,
- horizontal / vertical bar charts,
- horizontal / vertical line charts,
- in the form of an indicating meter,

Additionally, binary values 0/1 can be presented in two ways - as numerical values or as text.

All channels of a given group are presented simultaneously in the same way.

It is possible to switch between individual views and groups. Figure 10 shows the different presentation modes of logical channel groups called from the navigation bar with buttons.



Fig.10 Examples of the measurement data presentation mode

## 6.5 Configuration of KD6 parameters

To enter the configuration of recorder parameters, press the button **Menu**. Use the buttons **▼** **▲** to select the appropriate configuration window and confirm by pressing the button **Select**. Return to the measurement and recording mode is carried out by means of buttons **Back** and **Exit**.

Configuration menu:

- General settings of the recorder, see section 6.5.1
- Inputs, see section 6.5.2
- Outputs, see section 6.5.3
- Logical channels, see section 6.5.4
- Groups, see section 6.5.5
- Functions, see section 6.5.6
- Modbus Slave, see section 6.5.7
- Modbus Master / Slave, see section 6.5.8
- Ethernet, see section 6.5.9
- Safety, see section 6.5.10
- Information, see section 6.5.11

### 6.5.1 General settings of the recorder

General settings menu allows you to change the display language of the user interface, set the current date and time, restore factory parameters and set the time to the minimum brightness (LCD backlight) and the time of group switching (option enabling cyclical changes of the displayed group).

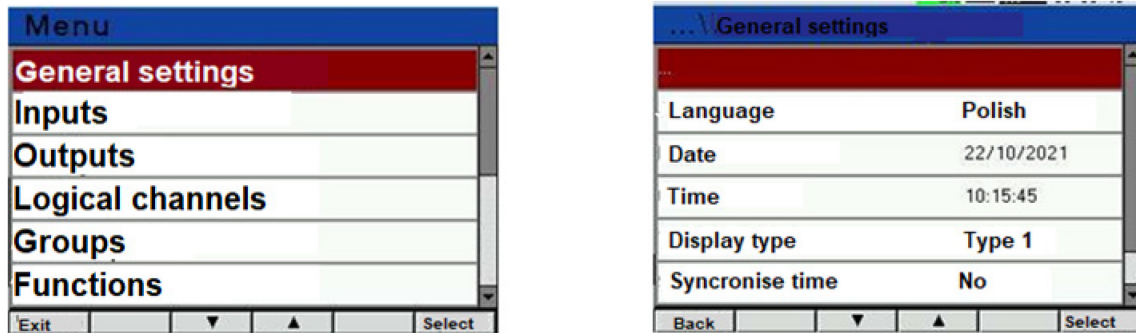

Fig.11 General settings

Menu parameters include as General settings:

Table 1.

No	Parameter name	Feature/value	Description	Factory set
1	Language	English, Polish, Deutsch		English
2	Date	dd / mm / yyyy	Day /month /year	01/06/2020
3	Time	hh:mm:ss	hours: minutes: seconds	
4	Display type	Type 1, Type 2	Type of display used	Depending on equipment
5	Synchronise time	No Yes	Synchronization with the time server	No
6	Factory parameter settings	No Yes	Restore manufacturer settings	No

### 6.5.2. Inputs

The device has 2 binary inputs In1, In2 in slot Z and inputs related to the installed input modules in slots X, Y (according to the customer's order) as standard. The configured input can be used by any logical channel to visualize the result or to further process the input data.

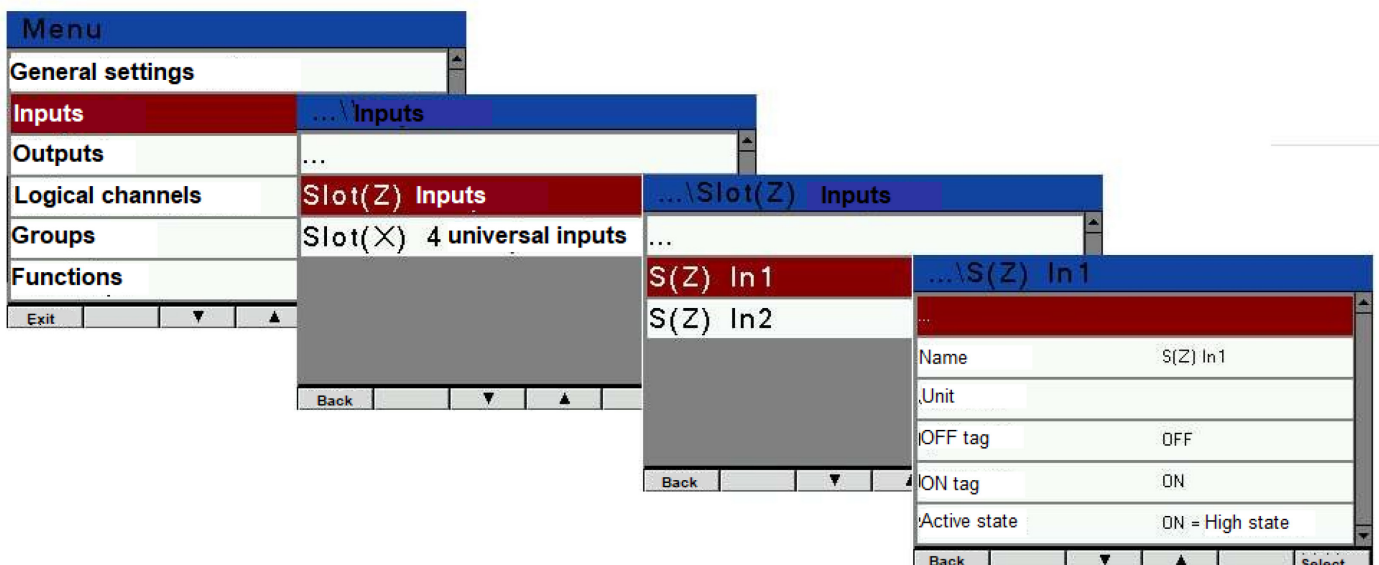

Fig.12 Binary inputs

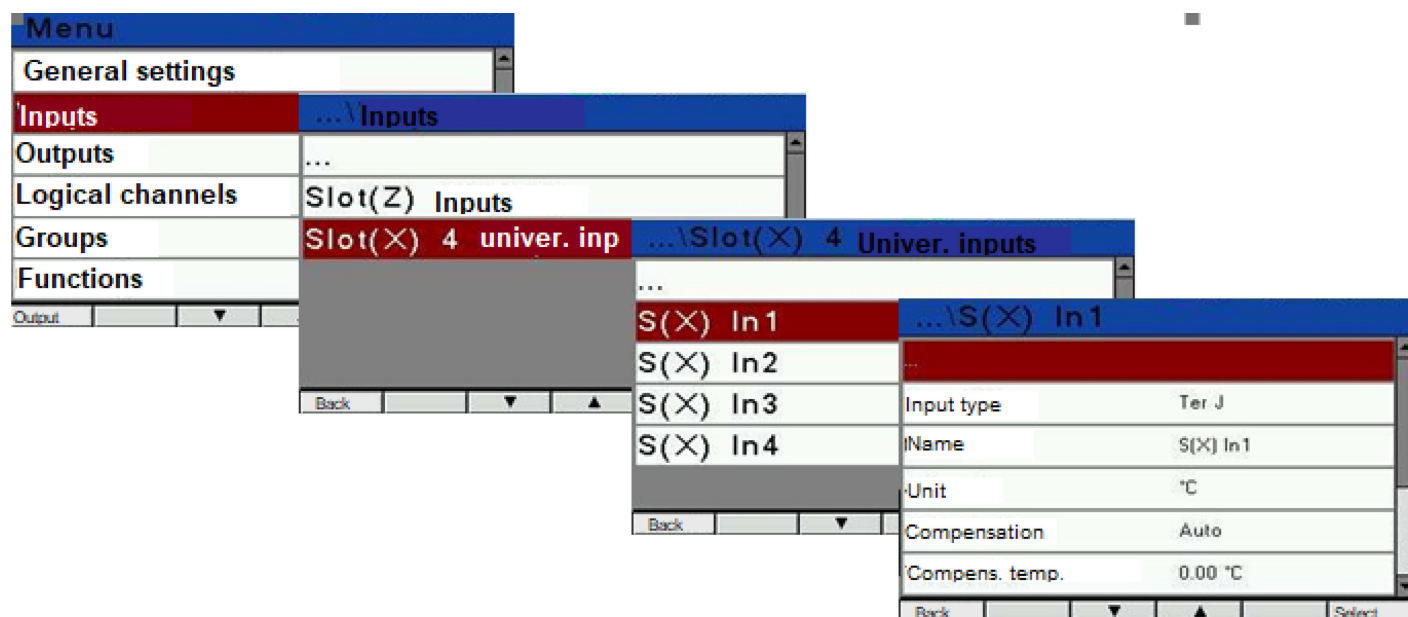

Fig.13 Universal inputs

Table 2.

No			Parameter name	Range	Notes/ description	Factory set
1	S	Binary input	Name		Name edition	
2			Unit		N/A	
3			OFF tag		Tag edition	OFF
4			ON tag		Tag edition	ON
5			Active state		ON = high state of input active ON = low state input active.	ON = high state
6		Universal input, voltage, current, resistance	Input type	-10..10, 0..10 V -300 ..300 mV, 0..300 mV -75..75 mV, 0..75 mV -40..40 mA, 0..40 mA 0..4000 Ω		-10..10 V
7			Name	S(X) In1.. S(Y) In4		S(X) In1..4
8			Unit	V, mV, mA, Ω		V
9			Filter	0.5..60.0 s		0,5 s
10			Min	-12 V, -360 mV, -90 mV, -48 mA, 0 Ω	Depending on the input range	-12.0 V
11			Max.	12 V, 360 mV, 90 mV, 48 mA, 405 Ω		12.0 V
12		Input Pt100/ 500/ 1000	Input type	Pt100, Pt500, Pt1000		
13			Name	S(X) In1.. S(Y) In4		S(X) In1..4
14			Unit	°C, °F		°C
15			The way of connecting the sensor		3 wire 2 wire	2 wire
16			Wires resistance	0.00..60.00 Ω,		0 Ω



## User's manual

17			Correction	-20.0..20.0 °C		0°C
18			Filter	0.5..60.0 s		0,5 s
19			Min			-200.0°C
20			Max.			850.0°C
21		Input Ter J, K, N, E, T, S, R, B	Input type	Ter J, K, N, E, T, S, R, B		
22			Name	S(X) In1.. S(Y) In4		S(X) In1..4
23			Unit	°C, °F		°C
24			Compensation	Auto, Manual		Manual
25			Comp. temp.	0.00..60.00 °C		0.0°C
26			Correction	-20.00..20.00 °C		0.0°C
27			Filter	0.5..60.0 s		0,5 s
28			Min	-55°C	Depending on the choice of the thermocouple	
29			Max.	1765°C	Depending on the choice of the thermocouple.	

### 6.5.3 Outputs:

Depending on the customer's needs, additional relay or analogue output modules can be installed in the appropriate X, Y slots in the device.

As standard, there are 2 relay outputs Out1, Out2 in the Z slot. The configured output can be used by any logical channel to visualize the result or to further process it.

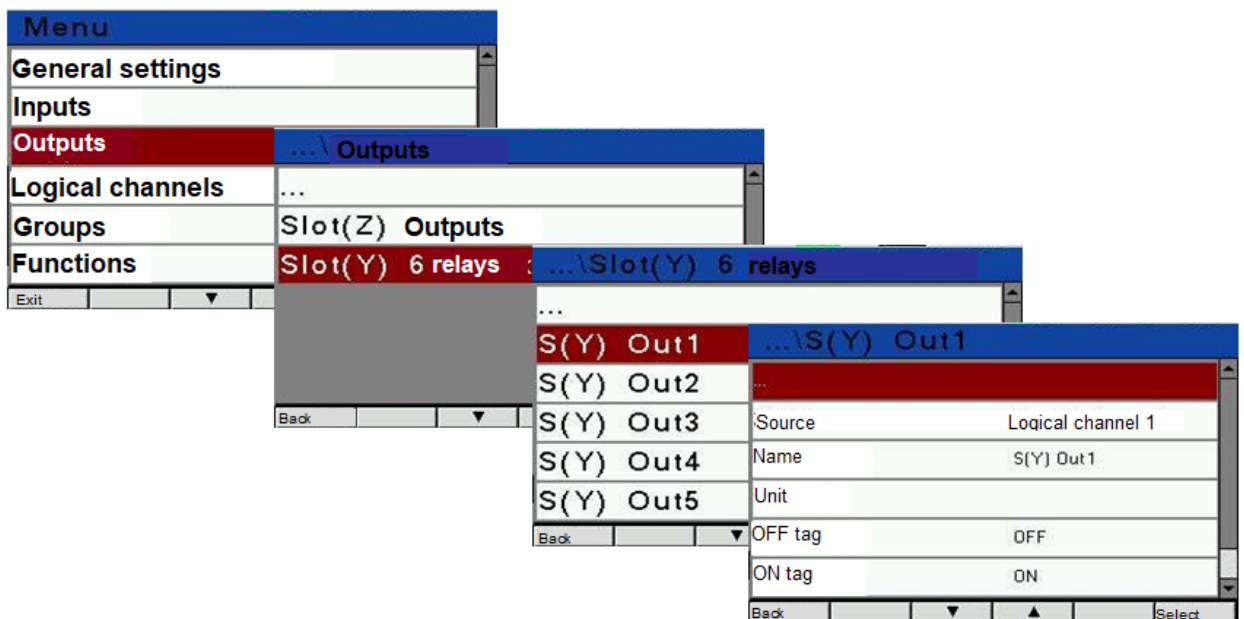

*Fig.14 Relay outputs*

Table 3.

No			Parameter name	Range	Notes/ description	Factory set		
1	Slot (X), Slot (Y), Slot (Z)	S(X) Out1..Out4, S(Y) Out1..Out4, S(Z) Out1, Out2	Relay outputs	Source:	Logical channel 1 ... Logical channel 60	Selection of logical channel (1..60)	Logical channel 1	
2			Name		Output name	S(Y) Out1		
3			Unit		Unit name ( only reading)			
4			OFF tag		Description edition	OFF		
5			ON tag		Description edition	ON		
6			Active state		On Off	On		
7		Analogue output	S(X) Out1..Out4, S(Y) Out1..Out4, S(Z) Out1, Out2	Analogue output	Source:	Logical channel 1 ... Logical channel 60		Logical channel 1
8				Name		Output name	S(X) Out1	
9				Unit	mA	Unit name ( only reading)	mA	
10				Value when ERR	0/4..20 mA		0.00	
11				Lower input value	+/- 21474000.00		-99999.99	
12				upper input value	+/- 21474000.00		99999.99	
13				Lower output value	0..20 mA		4.00 mA	
14				upper output value	0..20 mA		20.00 mA	
15				Output range	0..20 /4..20 mA		0..20 mA	

#### 6.5.4 Logical channels

Logical channels are a bridge between physical inputs and outputs and the control and visualization process.

This mode allows the user to configure the device to read data from the input / output modules installed in it, to display it on the screen, use it in calculations in other logical channels, or use it as a data source for the control output of any object.

The data source for the logical channel can be:

- measurement values from analogue inputs, binary inputs, and other devices read via the Modbus master interface,
- functions: mathematical, scaling, alarm,
- states on hardware outputs (analogue outputs, binary outputs),
- values from other logical channels.

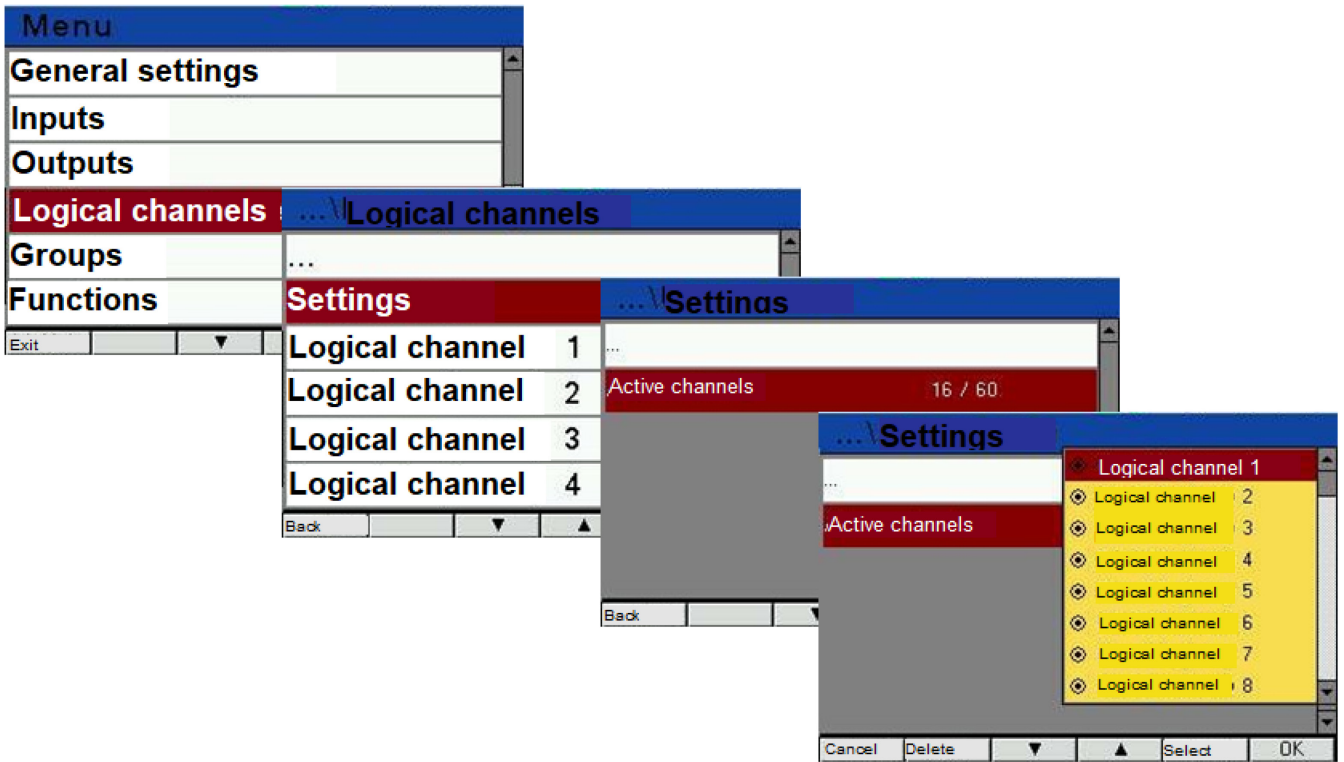

Fig.15 Logical channels – settings

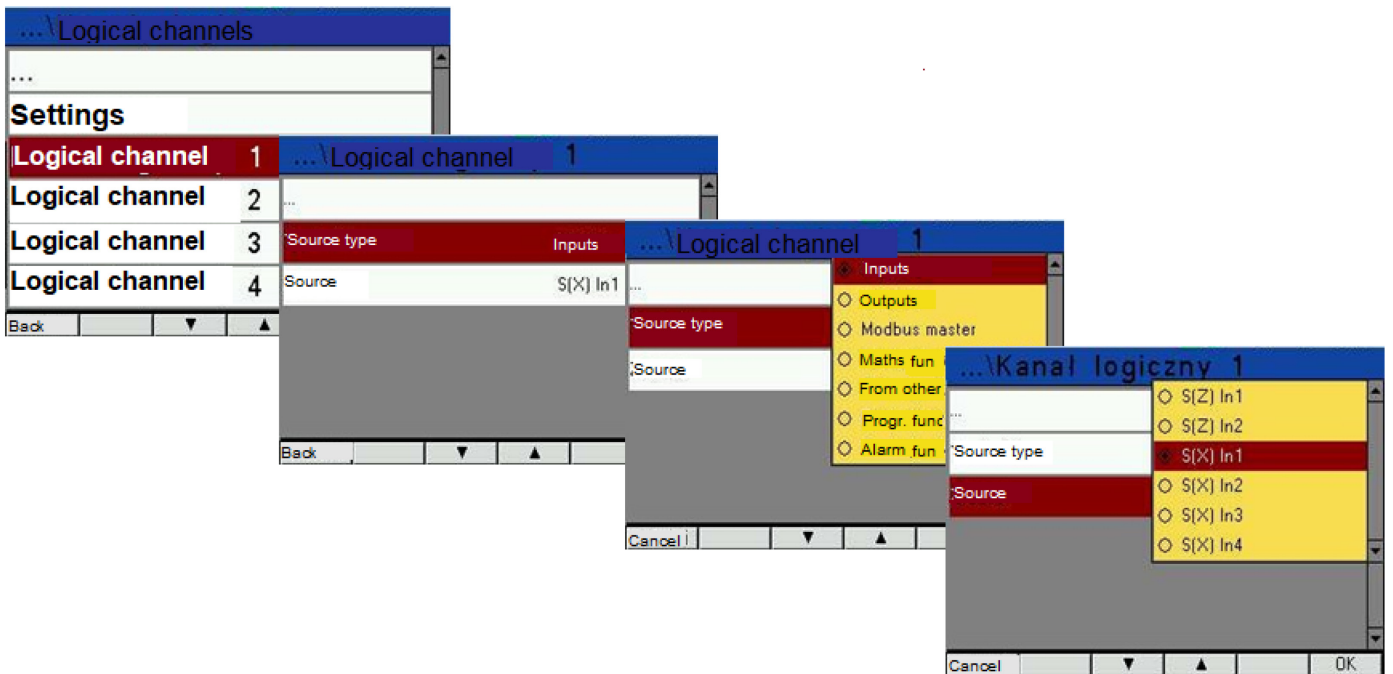

Fig.16 Logical channels - source

Table 4

No		Parameter name	Range	Notes/description	Factory set
1	Settings	Active channels	1..60	Channels selection	Channels 1..16
2	Logical channel 1..60	Source type	Inputs, Outputs, Modbus master Mathematical function From other channel Scaling function Alarm function		Inputs
3		Source:	Inputs S(Z) In1, S(Z) In2, S(X) In1 .. S(X) In4, S(Y) In1 .. S(Y) In4 Outputs: S(Z) Out1, S(Z) Out2, S(X) Out1 .. S(X) Out4 / 6, S(Y) Out1 .. S(Y) Out4 / 6 Modbus master: Master 1 .. Master 10 Mathematical function Mt1 .. Mt 20 From other channel Logical channel 1.. Logical channel 10		S(Z) In1

			Scaling function Scal 1 Scal 20 Alarm function Alarm 1 Alarm 20		
--	--	--	--	--	--

### 6.5.5 Groups

**A group is a set of up to six logical channels.** The device can only display channels assigned to the given Group on the same screen. Each logical channel can belong to one or more groups simultaneously or belong to no group.

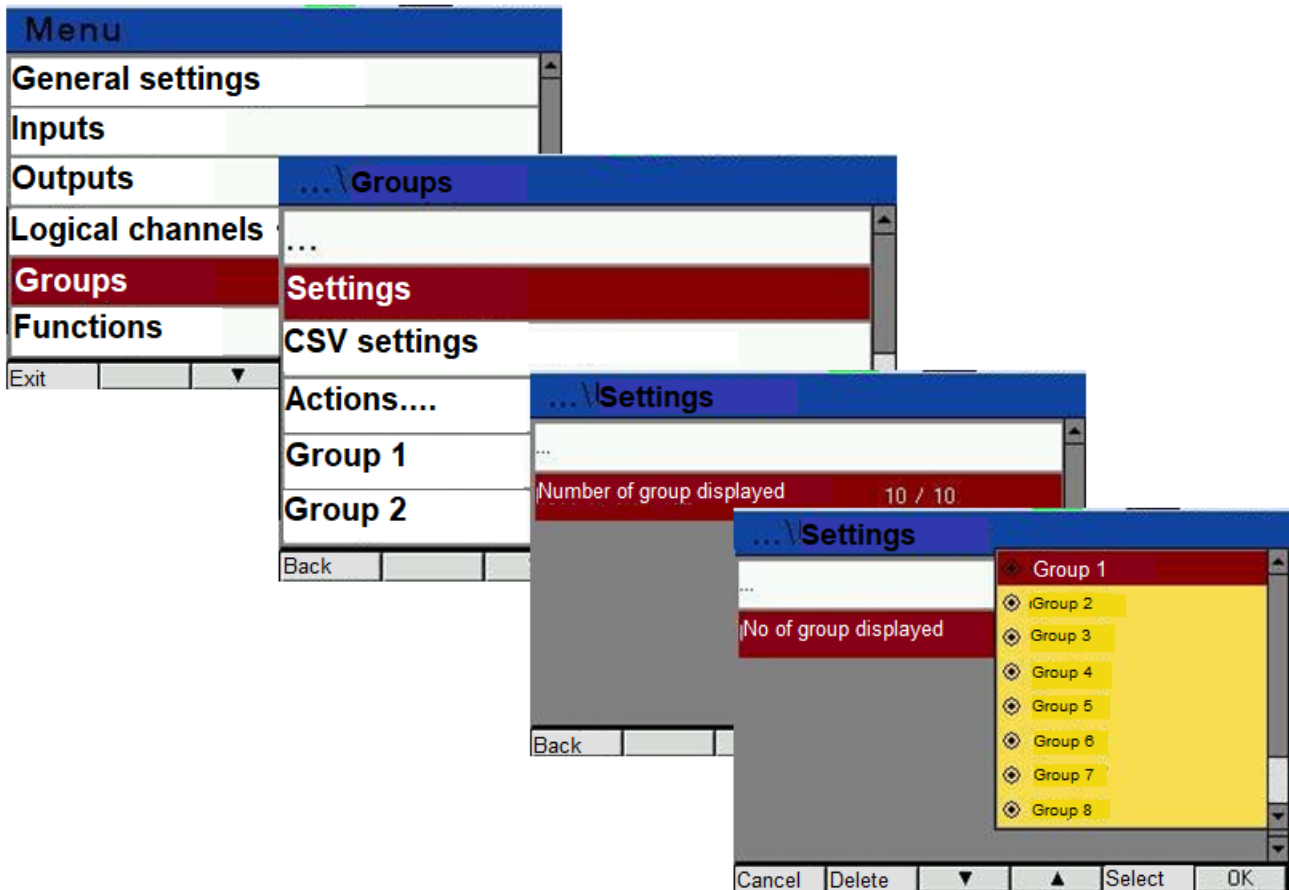

Fig.17 Groups - settings

Table 5.

No		Parameter name	Range	Notes/ description	Factory set
1	Settings	Number of displayed groups	1. 10		10
2	CSV settings	Field separator	Comma, Semicolon, Tab		Comma
3		Decimal separator	Dot Comma		Dot
4	Actions...	Auto export / files export	Off. On	It means transfer of completed files and automatic transfer of new created archives files to external memory	Off
5		Copy archives to CSV file	No Yes	Transfer of recorded values to new files in internal memory	No

6		Delete archives	No Yes	Deleting internal memory of recorder	No
7	∞ ∞	Quantity of displayed groups	1. 6		6
8		Type of bar diagrams	Off Horizontal Vertical		Horizontal
9		Type of linear diagrams	off Horizontal Vertical		Horizontal
10		Time base	30 sec. 7 days		2 min.
11		Colour of background	Black White	Selection	Black

12	Display field 1 .. 6	Archive type	Manually off Manually on Below Above Intern. Extern.		Manually Off
13		Triggering	Logical channel 1.. Logical channel 60		Logical channel 1
14		Interval	1 .. 3600 s		1
15		Lower threshold	-214740000 .. 214740000		-999999.9
16		Upper threshold	-214740000 .. 214740000		999999.9
17		Signal source	Logical channel 1... Logical channel 60		Logical channel 1
18		Decimal point	Auto, None, 0.0; 0.00; 0.000		Auto
19		Binary values displayed as ...	Value Text	0, 1 are displayed for the values. For the text displayed there are inscriptions: OFF, ON. In the case of the maths functions 4 ... 6, 18 ... 28 subtitles TRUE, FALSE are displayed	Value
20		Number of sectors	1 .. 6		1
21		Colour of sector 1	Green, Red, Yellow, White, Blue, Purple, Bright blue, Olive, Black, Bright green, Orange, Dark red, Grey	When choosing the colour of the sector you should have in mind chosen background colour to have information displayed on screen clearly visible.	Green
22		Value 1	+/- 214740000.0		0.0
23		Colour of sector 2	<i>As for sector 1</i>		Red
24		Value 2	+/- 214740000.0		100.0
25		Colour of sector 3	<i>As for sector 1</i>		Yellow
26		Value 3	+/- 214740000.0		200.0
27		Colour of sector 4	<i>As for sector 1</i>		White
28		Value 4	+/- 214740000.0		300.0
29		Colour of sector 5	<i>As for sector 1</i>		blue
30		Value 5	+/- 214740000.0		400.0
31		Colour of sector 6	<i>As for sector 1</i>		Purple

### 6.5.6 Functions

In the Functions mode, the user can define a mathematical, scaling and alarm function, the result of which can be displayed on the device screen. The user can use the output value in the conversion in other logical channels or use this data as a data source for the output to control any object.

#### Mathematical functions

In addition to the basic mathematical functions: addition, subtraction, multiplication and division, the device allows you to operate logical functions, calculate the arithmetic mean, search for the maximum and minimum value and many other functions that are discussed in the table 7.

**Scaling functions**

It enables linear scaling of the result by means of a multi-point (2..10 points) characteristic.

**Alarm function**

Enables you to select the reaction of the alarm function in the event of an alarm state. The alarm occurs when the value from the logical channel being the data source meets the alarm conditions.

The recorder also allows you to set the behaviour of the alarm function when the value is outside the measuring range: lower or upper exceeding or a sensor or calibration error occurs.

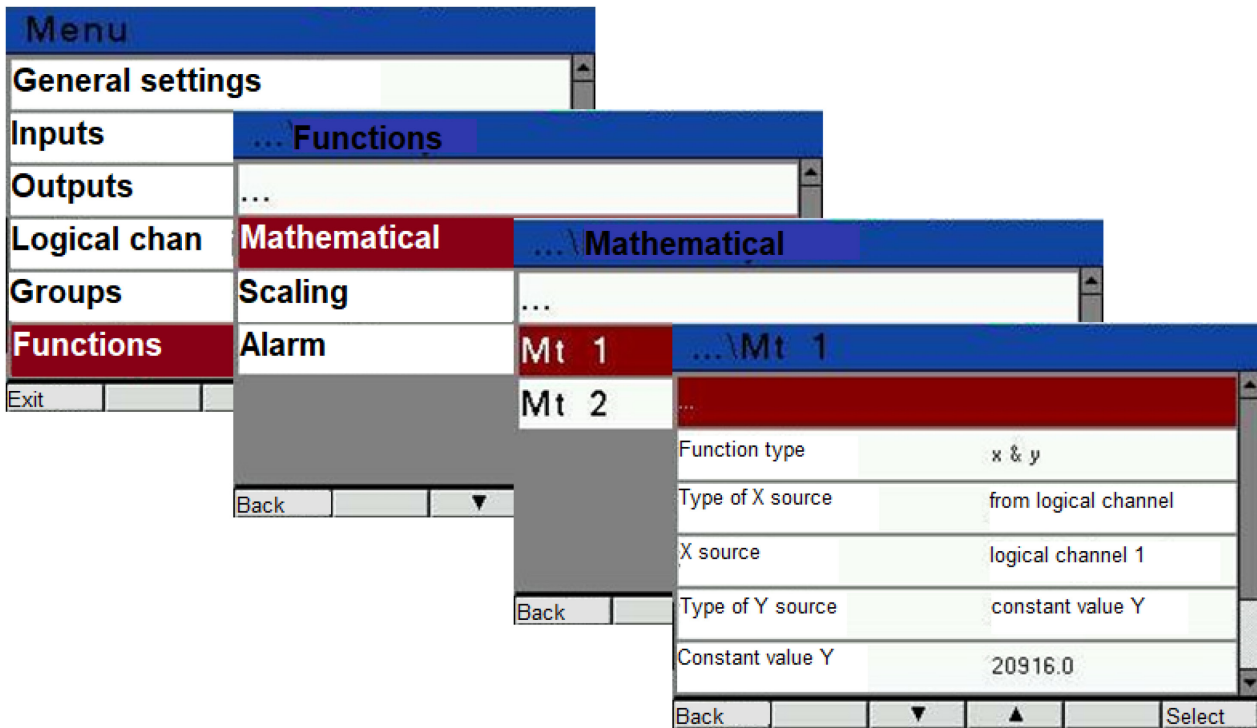

Fig.18 Mathematical functions

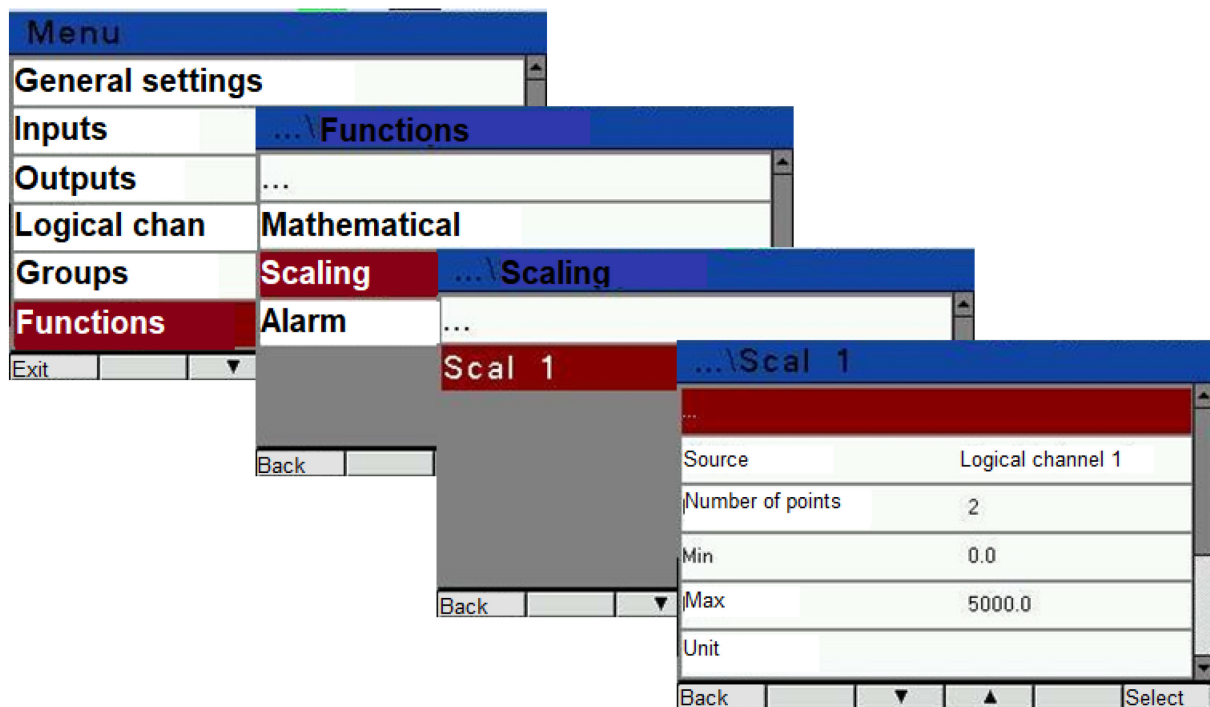

Fig.19 Scaling functions

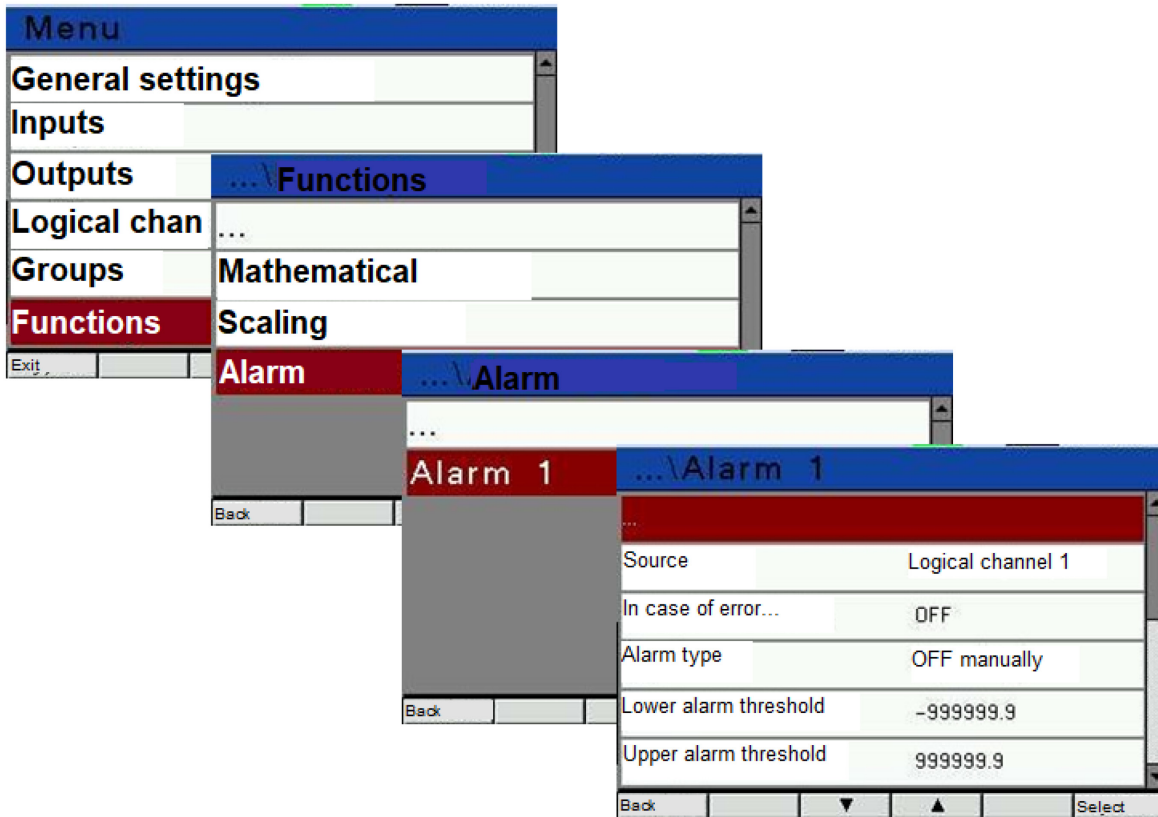

Fig.20 Alarm functions

Table 6.

No		Parameter name	Range	Notes/ description	Factory set
1	Mathematical functions Mt1...Mt20 (assigned in logical channels)	Function type	According to table 7.		Off
2		Type of Source X	From a logical channel, Constant value of X		From the logical channel
3		Source X	Logical channel 1. Logical channel 60		Logical channel 1
4		The value of X	+/-214740000.0		0.0
5		List of channels	Logical channel 1. Logical channel 60	Select up to 10 channels	0/10
6		In the event of an error	Add faulty channels, Skip faulty channels		Skip faulty channels
7		Type of source Y	From the logical channel, Constant Y value		
8		Source: Y	Logical channel 1. Logical channel 60		Logical channel 1
9		Y value	+/-214740000.0		0.0
10		Min	+/-214740000.0		
11		Max.	+/-214740000.0		



## User's manual

12	Scaling functions Scal1..Scal 20	Source:	Logical channel 1... Logical channel 60		Logical channel 1
15		Number of points	2..10		2
16		Min	+/-214740000.0		0.0
17		Max.	+/-214740000.0		0.0
18		Unit		Unit edition	
19		X1	+/-214740000.0		0.0
20		Y1	+/-214740000.0		0.0
21		X2	+/-214740000.0		0.0
22		Y2	+/-214740000.0		0.0
24		In the event of an error	No reaction ON, OFF		OFF
25		Alarm type	Manually off, manually on, below, above, intern. extern.		Manually off
26		Alarm lower threshold	+/-214740000.0		-999999.9
27		Alarm upper threshold	+/-214740000.0		999999.9
28		Hysteresis	0 .. 6500.0		0
29		Alarm activation delay	0 .. 65000		0 s
31		Min alarm activation time	0 .. 65000		0 s
32		Min alarm off time	0 .. 65000		0 s
33		Lock off alarm	Off. On		Off
34		Alarm signalling	Off. On		Off
35		Alarm reset	No Yes		No

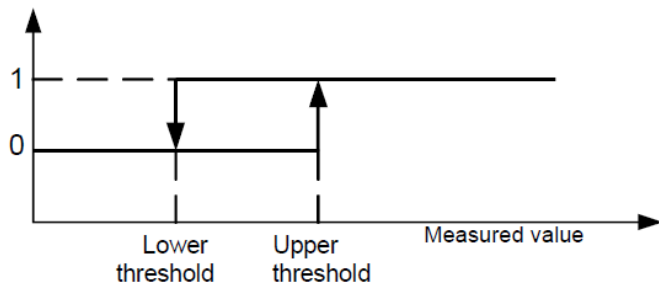

a) above

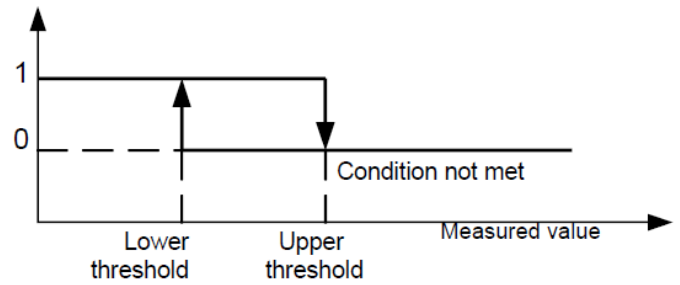

b) below

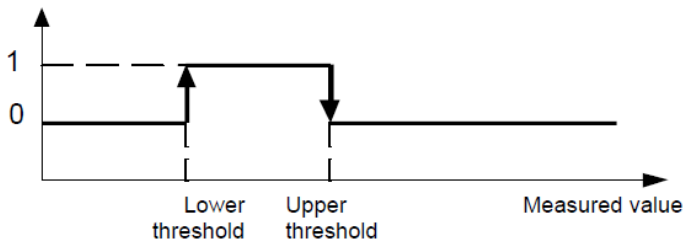

c) internal

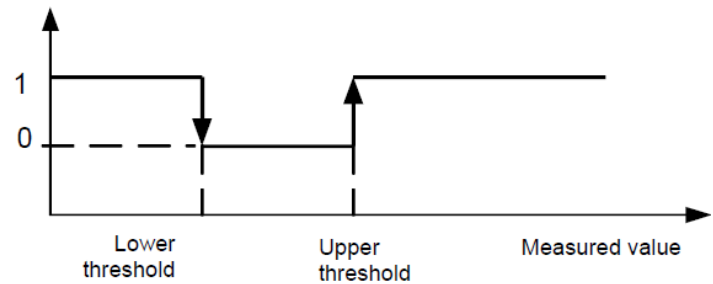

d) external

Fig.21 Alarm types or archiving types

- 0 - alarm status or archiving status not fulfilled
- 1 - alarm status or archiving status fulfilled

Other types of alarms or types of archiving:

- **Manually on** - always on;
- **Manually off** - always off,

List of available mathematical functions:

Table 7.

No	Function	Description
1.	round(x)	Returns the value of x rounded to the nearest integer
2.	sqrt(x)	The square root of x
3.	abs(x)	Absolute value of x
4.	isErr(x)	Returns 1 if the value is incorrect (e.g. Err, Lo, Hi)
5.	isLo(x)	Returns 1 if the value is incorrect (lower range exceeding)
6.	isHi(x)	Returns 1 if the value is incorrect (upper range exceeding)
7.	avg(x1,x2,x3,...)	Returns the average value of the numbers x1, x2, x3 ...
8.	sum(x1,x2,x3,...)	Returns the sum of the numbers x1, x2, x3 ...
9.	product(x1,x2,x3,...)	Returns the product of the numbers x1, x2, x3 ...
10.	min(x1,x2,x3,...)	Returns the minimum value of the numbers x1, x2, x3 ...
11.	max(x1,x2,x3,...)	Returns the maximum value of the numbers x1, x2, x3 ...
12.	x + y	Addition
13.	x - y	Subtraction
14.	x * y	Multiplication
15.	x / y	Division
16.	x ^ y	Exponentiation

## User's manual

17.	-x	Negation of the sign of the number x
18.	x > y	The logical operator greater than. Returns 1 if true, 0 if false.
19.	x < y	Logical operator less than .. Returns 1 if true, 0 if false.
20.	x >= y	Logical operator greater than or equal to. Returns 1 if true, 0 if false.
21.	x <= y	Logical operator less than or equal to. Returns 1 if true, 0 if false.
22.	x != y	The logical operator is different Returns 1 if true, 0 if false.
23.	x == y	The logical comparison operator. Returns 1 if true, 0 if false.
24.	(x>0) AND (Y>0)	result = 1 if x and y are greater than zero otherwise the result is 0
25.	(x>0) OR (Y>0)	result = 1 when x or y is greater than zero w otherwise the result is 0
26.	(x>0) XOR (Y>0)	result = 1 when one of the values is greater than zero and the other is less than or equal to zero. If both values are less than or equal to zero, or both are greater than zero, the result is 0
27.	x & y	Logical product (conjunction). Returns 1 if true, 0 if false.
28.	x   y	logical sum (alternative). Returns 1 if true, 0 if false.

### Notes

- Trigonometric functions operate on radians
- Logical **true and false** - a value other than 0 is treated as a logical value **true**, a value equal to 0 is treated as a logical value **false**.
- Functions **min, max, sum, avg, product** and all the others operate on instantaneous values, e.g. the **sum** function gives the sum of the instantaneous values given as parameters and not the sum of these values over time.

### 6.5.7 Modbus Slave

In the options, select Modbus Slave and approve the selection with the button Menu. The list of Modbus Slave protocol parameters is presented in the table 8.

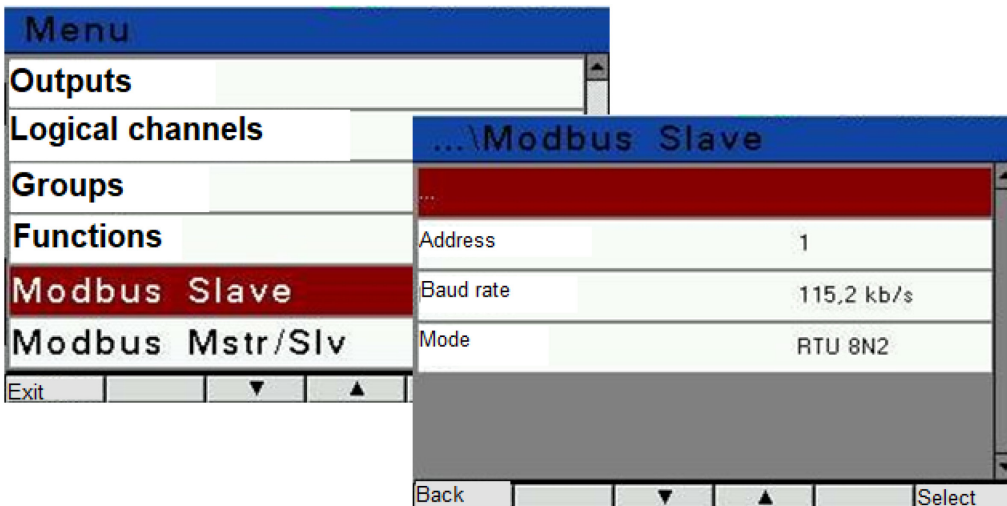

Fig.22 Configuration of Modbus protocol parameters in Slave mode

Table 8.

No	Parameter name	Feature/value	Description	Factory set
1	Address	1 .. 247	Address in Modbus net	1
2	Baud	9600 b/s, 19,2 kb/s, 38,4 kb/s, 57,6 kb/s, 115,2 kb/s	Baud rate:	115,2 kb/s
3	Mode	RTU 8N2, RTU 8E1, RTU 8O1, RTU 8N1	Transmission mode:	RTU 8N1

### 6.5.8 Modbus Master / Slave

Modbus Master / Slave (Mstr / Slv) mode allows to configure the KD6 recorder for reading data from the SLAVE device sent via the RS-485 Master / Slave bus.

Data read in Modbus Master mode can be assigned to logical channels and then they can be:

- displayed on the screen,
- used for calculations in other logic channels or as a data source for outputs to control any object.

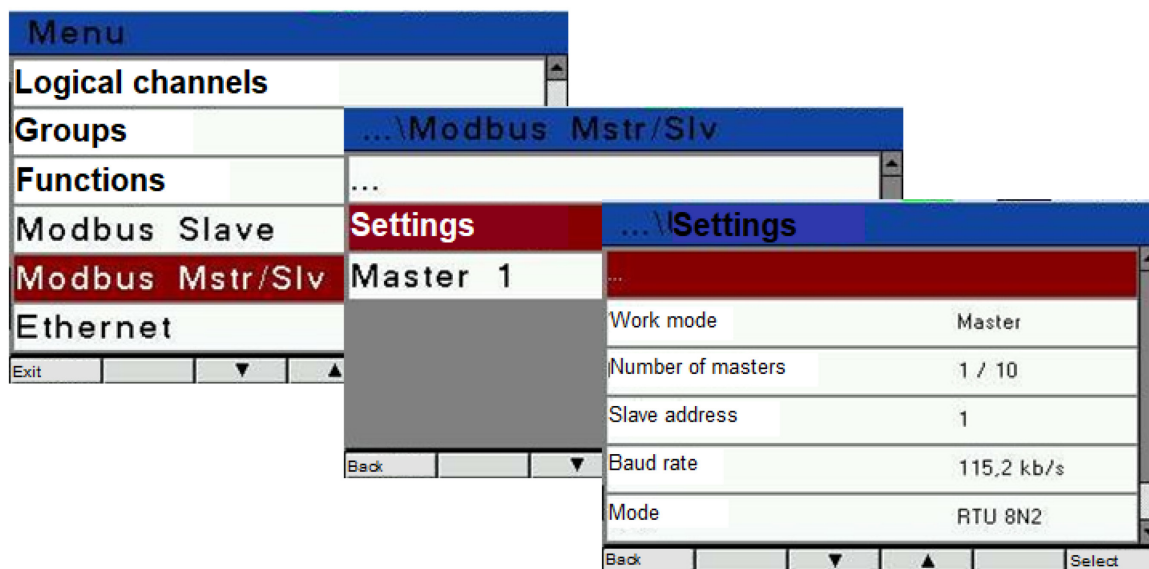

Fig.23 Configuration of Modbus protocol parameters in Master mode - general settings

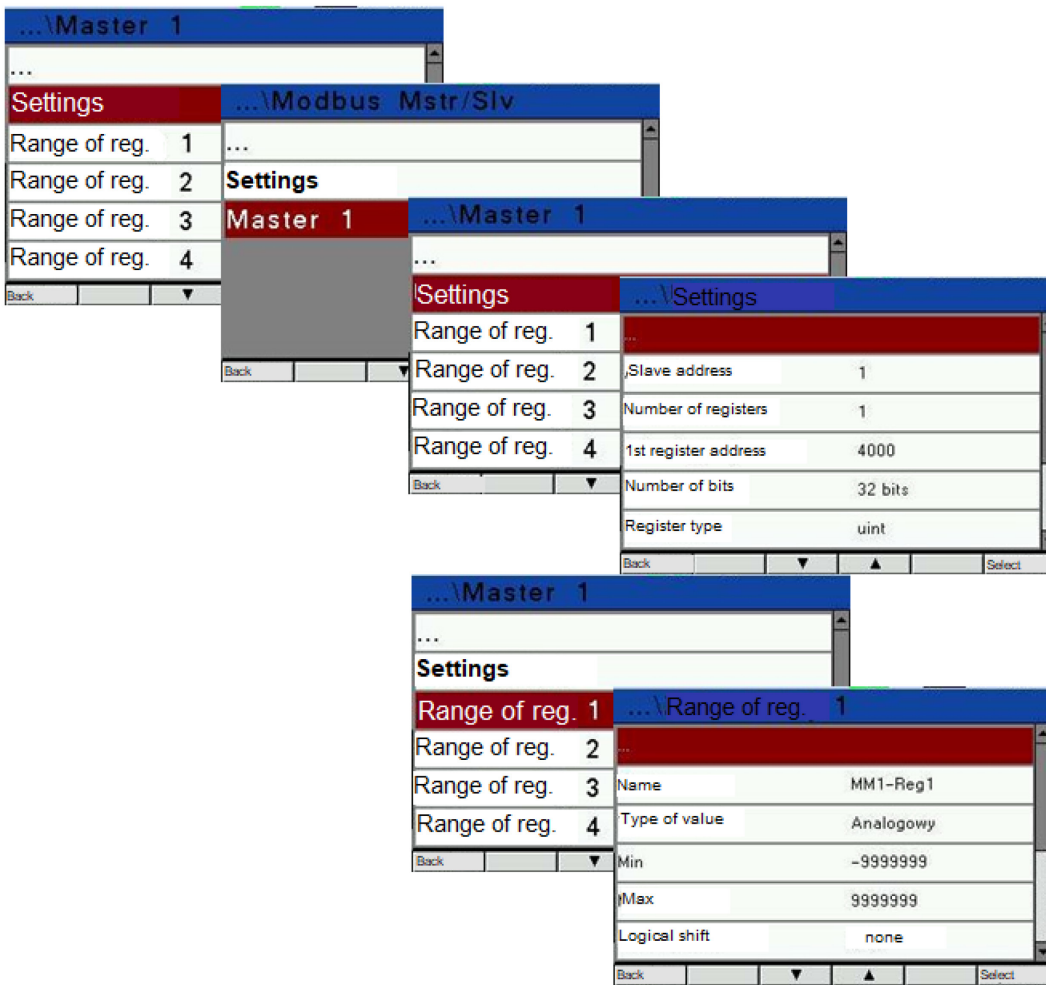

Fig.24 Configuration of Master 1 - Master 10 parameters

Table 9.

No		Parameter name	Range	Notes/ description	Factory set	
1	M	Settings	Work mode	Slave, Master		Slave
2			Quantity of masters	Master 1 .. Master 10		1
3			Slave address	1 .. 247		1
4			Baud	9600 b/s, 19,2 kb/s, 38,4 kb/s, 57,6 kb/s, 115,2 kb/s	Baud rate:	115,2 kb/s
5			Mode	RTU 8N2, RTU 8E1, RTU 8O1, RTU 8N1	Transmission mode:	RTU 8N1
6			Number of repetitions	0 .. 10		0
7	M	Settings	Slave address	1 .. 247		1
8			Number of registers	1 .. 10		1
9			Address of register 1	0x0000 .. 0xFFFF		4000
			Number of bites	32 bits / 16 bits		16 bits
10			Register type	char / uchar / int / uint / long / ulong / float 1234/2143/4321/3412		float4321
11			Reading function	0x03, 0x04		0x03
12			Response waiting time	100 .. 10000 ms		1000 ms
13			Repetition interval	100 .. 10000 ms		1000 ms
14	R		Name	ASCII chars		MM1-Reg1

15		Value type	Analogue, Binary	Binary
16		Min	+2147000000	-9999999
17		Max.	+2147000000	9999999
18		Logical shift	<i>None / &gt;&gt;right / &lt;&lt;left</i>	none
19		N bites logical shift	1 .. 31	7
20		OFF tag	<i>ASCII chars</i>	OFF
21		ON tag	<i>ASCII chars</i>	ON
22		Unit	<i>ASCII chars</i>	

### 6.5.9 Ethernet

The Ethernet menu allows you to configure the network settings in order to download and visualize data from the device via the Ethernet link.

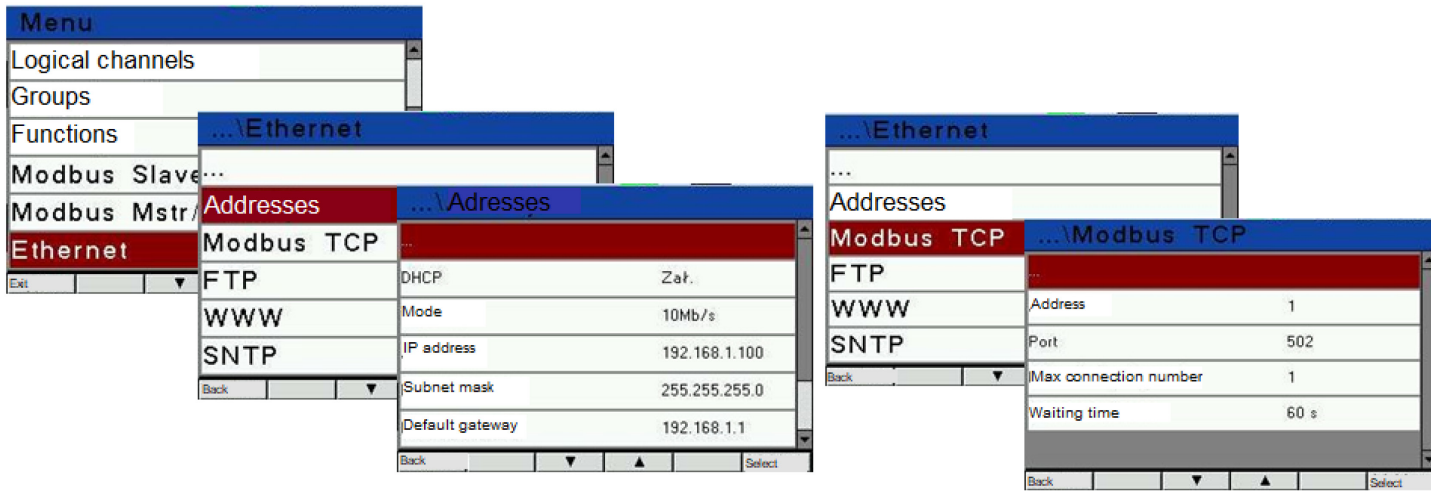

Fig.25 Ethernet – addresses

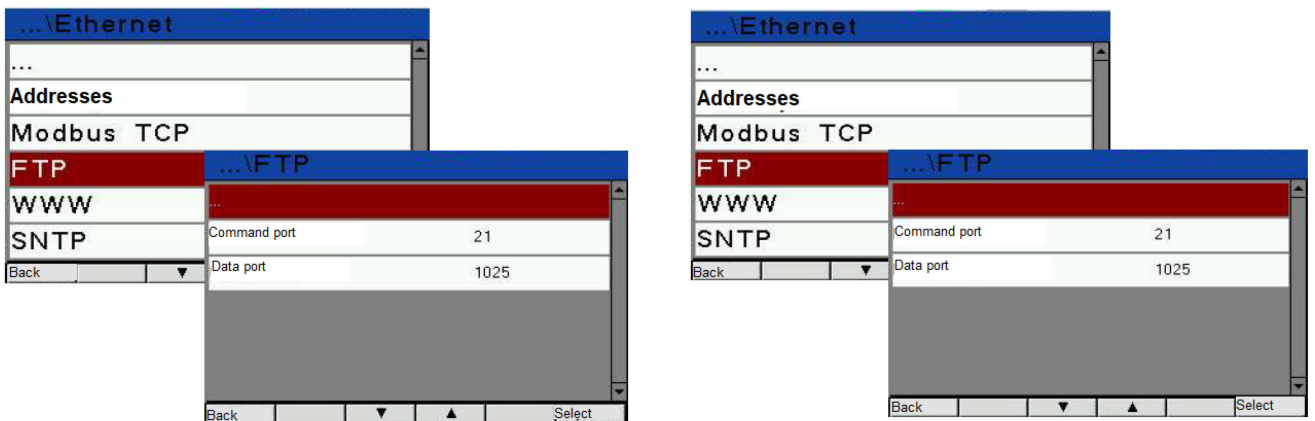

Fig.26 Ethernet – FTP

Table 10.

No		Parameter name	Range	Notes/ description	Factory set	
1	Addresses	DHCP	Off/On	Enabling / disabling the DHCP client (support for automatic acquisition of IP protocol parameters of the meter Ethernet interface from external DHCP servers within the same local area network (LAN))	Off	
2		Mode	Auto, 10Mb/s, 100Mb/s		Auto	
3		IP address	0.0.0.0...255.255.255.255	10.0.1.161	Obtained from DHCP or entered manually when DHCP off	-
4		Subnet mask	0.0.0.0...255.255.255.255	255.0.0.1		-
5		Default gateway	0.0.0.0...255.255.255.255	0.0.0.0		-
6		DNS address	0.0.0.0...255.255.255.255	10.0.0.44		-
7		MAC address		Aa:bb:cc:00:11:22	-	
8	Modbus TCP	Address	1 ... 247		1	
9		Port	80 ... 32000		1	
10		Max. number of connections	1 ... 4		1	
11		Waiting time	10 .. 360 s		60s	
12	FTP	Port of commands	20 ... 32000		21	
13		Data port	20 ... 32000		1025	
14	Web	Port	80 ... 32000		80	
15	SNTP	SNTP address	NTP server address	Time server IP address	10.0.17.49	
16		Time difference with respect to UTC time	+ or -	sign of the local time offset from UTC time	+	
18		Hours offset from UTC time	0 .. 12	Hourly value of local time offset from UTC time	1	
19		Automatic summer / winter time change	Yes, No		Yes	
20		Synchronise the time	No, Yes	Time synchronization command from time server	No	

**Description of the Ethernet setting parameters:**

**DHCP** - dynamic host configuration protocol of network nodes, a communication protocol that allows the device to obtain configuration data from the server, i.e. IP address, subnet mask, IP address of the default gateway.

**FTP File Transfer Protocol** enables bi-directional file transfer on an FTP server - FTP client system.

Connection via FTP protocol can operate in two modes: active and passive:

- if the FTP connection is in active mode, it uses port 21 for commands (set up by the client) and port 20 for data transfer (set up by the server),
- if the FTP connection works in passive mode, it uses port 21 for commands and a port number greater than 1024 for data transmission (both connections are established by the client).

**Modbus TCP** - Modbus RTU protocol with a TCP interface that runs on the Ethernet network.

**Web server port** - a parameter that allows you to select the server port on which the website

service is running. It allows you to connect to the device using a web browser on a selected port.

**SNTP address** - allows you to select the NTP server address, get the current time there from and, if necessary, correct the system clock. The device will connect to the selected server every 15 minutes and update its clock according to the time downloaded from the server.

**Synchronize time parameter** - enables immediate manual synchronization of the device clock with the time downloaded from the NTP server, and thus checking the correctness of the provided NTP server address.

### 6.5.10 Security

Table 11.

No		Parameter name	Range	Notes/ description	Factory set
1	Admin	Password enabled	No Yes		No
2		Password:	0 .. 9999		Auto

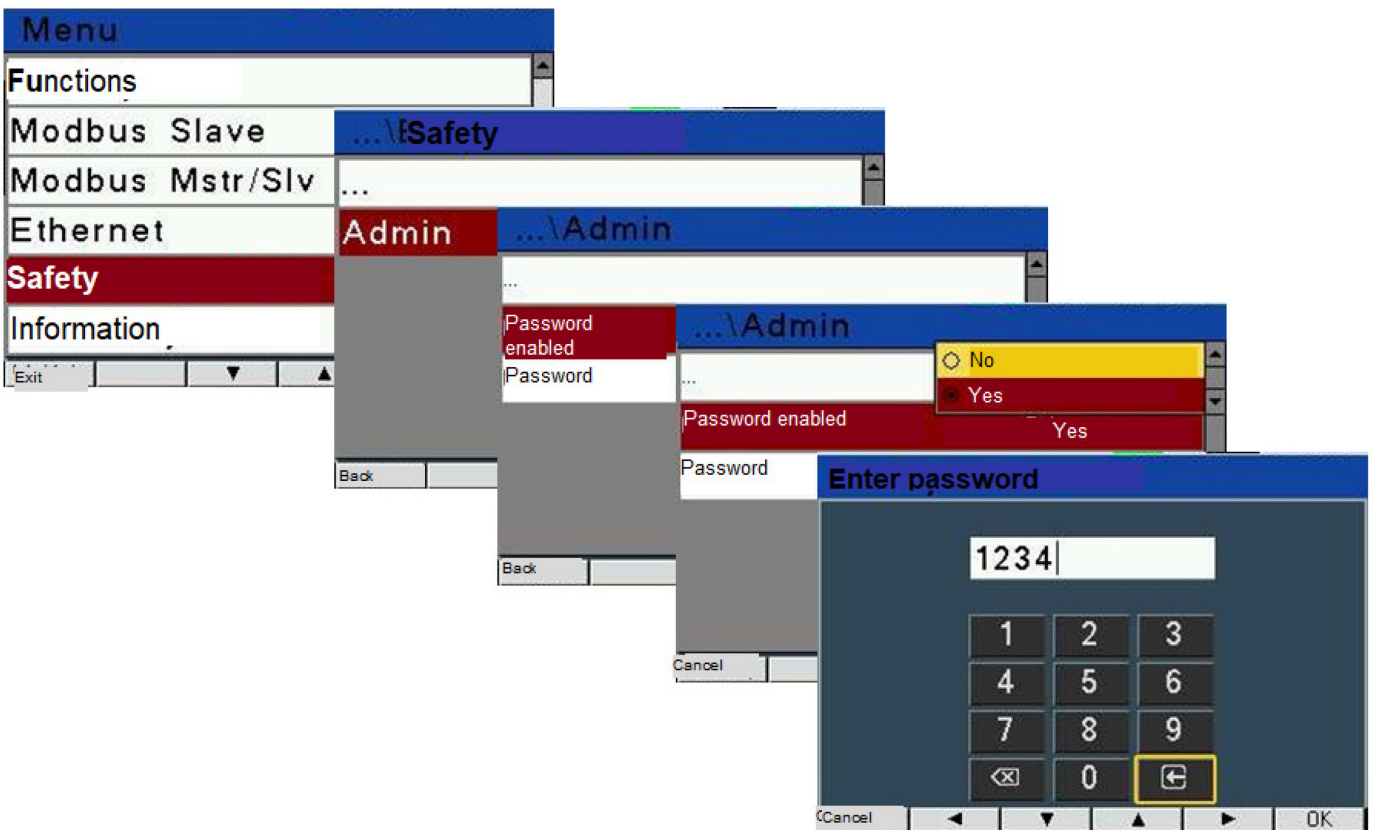

Fig.27 Security - access password activation



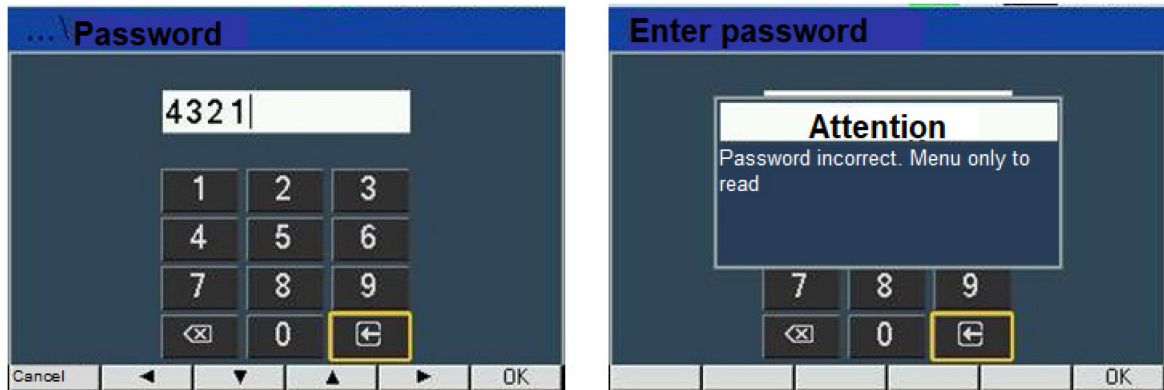

Fig.28 Security - an attempt to unblock the access password

### The principle of the access password

The intervention in the recorder configuration is protected with a password, if it has been entered and is different from zero. In the case of the password 0000, the password question is omitted. If the password is incorrect, the message 'Incorrect password. Read-only menu. ' is displayed. Then it is possible to review the recorder configuration, but the changes are blocked.

The password for the configuration menu and the recorder configuration via the modbus interface is the same, but the unlocking of both the menu and the modbus interface must be done separately. If we unlock the recorder from the display menu, the modbus interface remains locked, and if we unlock the modbus interface, the menu remains locked.

If we change the password in the recorder menu or through the modbus interface, the changed password now applies to both the modbus interface and the recorder menu. Note that when it comes to modbus interface, both of these facts apply to modbus RS485 and modbus TCP interface.

### Reading the MODBUS password register (register 4000)

- 1) If the value of register 4000 is read as 1: Then it means that the recorder is locked because the user entered a password other than "0000" to lock the recorder.
- 2) If the access to the recorder configuration is unlocked or the user has entered "0000" as the password, the register value 4000 is read as 0: This means full access to the recorder configuration, no password or the password lock has been disabled.

### Saving the MODBUS password register

1. If the recorder is blocked by a password, and the user wants to make changes in the recorder configuration, then the correct password should be entered into the register 4000 and only then the configuration can be modified.
2. If the recorder is locked with a password, and the user wants to disable it, enter the correct password to register 4000, and then enter the same register "0000" or:
  - In the recorder menu, set the parameter "Security-> Admin-> Disabled password" to - YES.
  - enter the value 0 into the register 4157 (lock with a password is disabled).
3. If the user enters an incorrect password into the register 4000: In this case, the user gets error 3 as invalid data value.
4. If the user wants to change the password, he enters the correct password in register 4000, and then the changed password in the same register.
5. If the user wants to unlock the access, then make changes in the recorder configuration and block this access again, he must enter the correct password to the register 4000, make

changes to the device configuration, and then enter the current password to register 4000.

**Note 1:** If the user has set the correct password, and it is a password other than "0000", and the user unlocks the password, then after turning the power off and on again, access to the configuration is locked again with a password.

**Note 2:** The valid range of password values for the MODBUS register 4000 is „0000 ... 9999”.

**Note 3:** The factory default password is "0000" and the password lock function is disabled.

### 6.5.11 Information

Using the Information menu, the user can learn basic information about the device: type of execution, loader and software version, installed I / O modules in slots (X) i (Y),

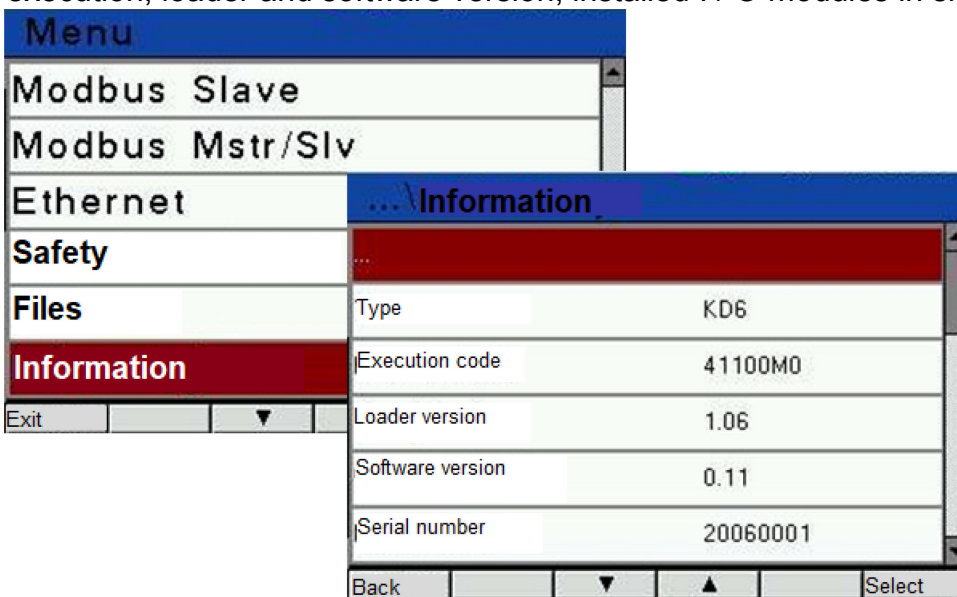

Fig.29 Information

Table 12.

No	Parameter name	Feature/value	Description	Factory set
1	Type			KD6
2	Execution code			e.g. .41100M0
3	Loader version			1.06
4	Software version			0.11
5	Serial number			21030001
6	Slot(X) card type			4 Universal input
7	Slot (X) loader version			2.01
8	Slot (X) software version			0.70
9	Slot(Y) card type			6 relays
10	Slot (Y) loader version			2.01
11	Slot (Y) software version			0.06
12	MAC address			aa:bb:cc:00:11:22
13	DHCP			On
14	IP address			192.168.1.100
15	Subnet mask			255.255.255.0
16	Default gateway			192.168.1.1
17	DNS address			10,200,121,121

## 7 Archiving measured values

### 7.1 Internal memory

KD6 recorders are equipped with 4MB internal memory and 8GB file archive memory intended for storing data recorded by the recorder. The internal memory of 4MB allows to register 40,960 records. This memory is a circular buffer.

### 7.2 Creating a file archive

After the internal 4MB memory is full by 70% or forced at any time: select the menu parameter "Groups → Activities → Copy archive to CSV file" set to "Yes".

Recorded data will be copied to the file archive. You can also start the procedure of copying to the archive via the RS485 interface (register 4095).

Example: file archive with the archiving period of 5 sec. allows registration for about 2 years. When the file archive is 70% full - the archive % full highlight will be orange (see: Status 3 Register - address 4417).

When the file archive is full to 95%, the overwrite mode starts when the oldest archive files are deleted during further archiving and new archive files are created.

When the file archive is full (less than 14 days until the file archive is full at 1 second interval), the highlighting colour will change to flashing red.

The KD6 recorder creates folders and files in the file archive during the internal memory copying. An example of the folders structure is shown in Figure 30.

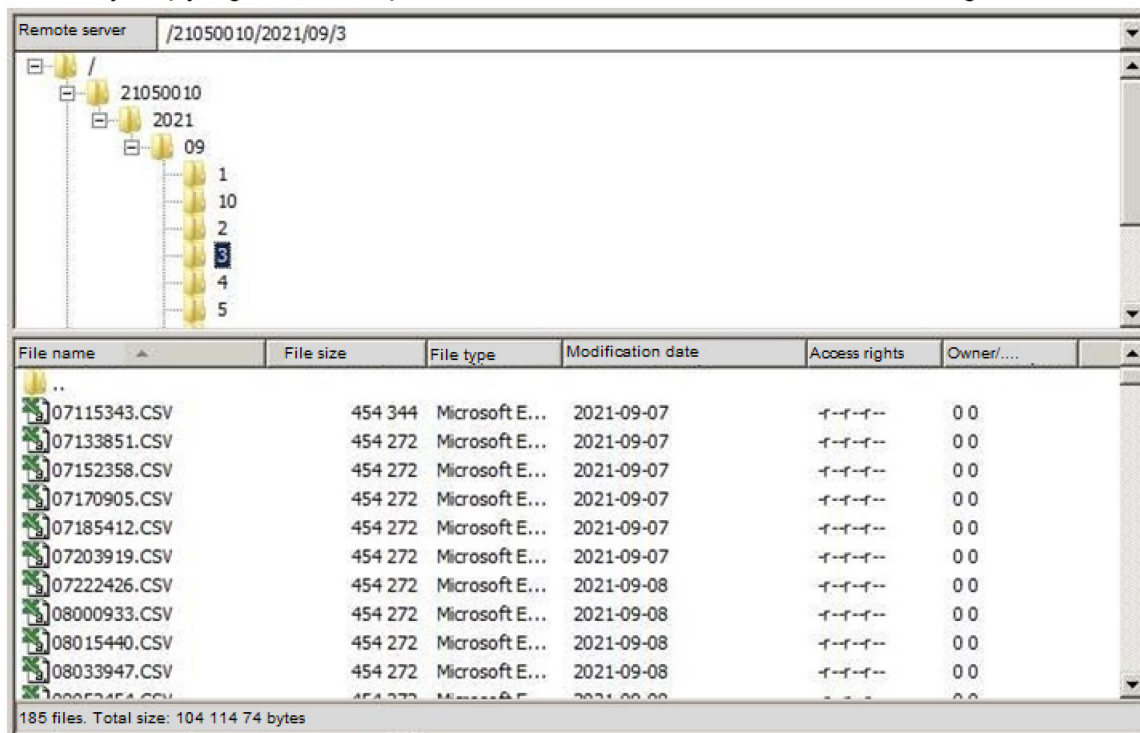

**Fig.30 Folders structure in the file archive**

The data in the archive are stored in files located in folders (year, month of copying the archive) - see Fig. 30. File names are marked as the day and time of copying the first record and have the format ddhhmmss.csv, where: dd-day, hh-hour, mm -minute, ss-second.

### 7.3 Building archive files

Files containing archived data have a column structure, where successive data columns are separated by a comma. The column description is placed in the first line of the file. Data records are arranged sequentially in lines. An example of a file is shown in Figure 31.

```
date,time,record index,block,register1,name1,value1, ... ,register6,name6,value6
2021-07-13,14:02:10,0000018394,10,14518,Ch10,0.000000E+00, ... ,14528,Ch15,0.000000E+00
2021-07-13,14:02:11,0000018395,10,14518,Ch10,0.000000E+00, ... ,14528,Ch15,0.000000E+00
2021-07-13,14:02:12,0000018396,10,14518,Ch10,0.000000E+00, ... ,14528,Ch15,0.000000E+00
2021-07-13,14:02:13,0000018397,10,14518,Ch10,0.000000E+00, ... ,14528,Ch15,0.000000E+00
2021-07-13,14:02:14,0000018398,10,14518,Ch10,0.000000E+00, ... ,14528,Ch15,0.000000E+00
2021-07-13,14:02:15,0000018399,10,14518,Ch10,0.000000E+00, ... ,14528,Ch15,0.000000E+00
2021-07-13,14:02:16,0000018400,10,14518,Ch10,0.000000E+00, ... ,14528,Ch15,0.000000E+00
2021-07-13,14:02:17,0000018401,10,14518,Ch10,0.000000E+00, ... ,14528,Ch15,0.000000E+00
2021-07-13,14:02:18,0000018402,10,14518,Ch10,0.000000E+00, ... ,14528,Ch15,0.000000E+00
2021-07-13,14:02:19,0000018403,10,14518,Ch10,0.000000E+00, ... ,14528,Ch15,0.000000E+00
2021-07-13,14:02:20,0000018404,10,14518,Ch10,0.000000E+00, ... ,14528,Ch15,0.000000E+00
2021-07-13,14:02:21,0000018405,10,14518,Ch10,0.000000E+00, ... ,14528,Ch15,0.000000E+00
2021-07-13,14:02:22,0000018406,10,14518,Ch10,0.000000E+00, ... ,14528,Ch15,0.000000E+00
2021-07-13,14:02:23,0000018407,10,14518,Ch10,0.000000E+00, ... ,14528,Ch15,0.000000E+00
2021-07-13,14:02:24,0000018408,10,14518,Ch10,0.000000E+00, ... ,14528,Ch15,0.000000E+00
2021-07-13,14:02:25,0000018409,10,14518,Ch10,0.000000E+00, ... ,14528,Ch15,0.000000E+00
2021-07-13,14:02:26,0000018410,10,14518,Ch10,0.000000E+00, ... ,14528,Ch15,0.000000E+00
2021-07-13,14:02:27,0000018411,10,14518,Ch10,0.000000E+00, ... ,14528,Ch15,0.000000E+00
2021-07-13,14:02:28,0000018412,10,14518,Ch10,0.000000E+00, ... ,14528,Ch15,0.000000E+00
2021-07-13,14:02:29,0000018413,10,14518,Ch10,0.000000E+00, ... ,14528,Ch15,0.000000E+00
2021-07-13,14:02:30,0000018414,10,14518,Ch10,0.000000E+00, ... ,14528,Ch15,0.000000E+00
2021-07-13,14:02:31,0000018415,10,14518,Ch10,0.000000E+00, ... ,14528,Ch15,0.000000E+00
2021-07-13,14:02:32,0000018416,10,14518,Ch10,0.000000E+00, ... ,14528,Ch15,0.000000E+00
2021-07-13,14:02:33,0000018417,10,14518,Ch10,0.000000E+00, ... ,14528,Ch15,0.000000E+00
2021-07-13,14:02:34,0000018418,10,14518,Ch10,0.000000E+00, ... ,14528,Ch15,0.000000E+00
2021-07-13,14:02:35,0000018419,10,14518,Ch10,0.000000E+00, ... ,14528,Ch15,0.000000E+00
2021-07-13,14:02:36,0000018420,10,14518,Ch10,0.000000E+00, ... ,14528,Ch15,0.000000E+00
2021-07-13,14:02:37,0000018421,10,14518,Ch10,0.000000E+00, ... ,14528,Ch15,0.000000E+00
```

**Fig.31 Sample archive file with data**

Subsequent fields included in the line describing the record have the following meaning:

- date - date of data registration, the “-” character is the date separator
- time - hour, minute, second of recorded data, the time separator is the character “:”
- record index - a unique index of the record. Each record has its own individual number. This number increases with the saving of subsequent records.
- block - reserved,
- register1 - Modbus register address of the first archived value,
- name1 - name of the logical channel of the first archived value,
- value1 - the first archived value. The decimal separator is “.”, The values are in engineering format.
- :
- register6 - Modbus register address of the sixth archived value,
- name6 - name of the logical channel of the sixth archived value,
- value6 - sixth archived value. The decimal separator is “.”, The values are in engineering format.

### 7.4 Archive download

Archived data can be downloaded via Ethernet using the FTP protocol or via an external memory connected to the USB Host connector (Menu parameter "Groups → Activities ... → Auto export / files export " set to "On").

## 8 Serial interfaces

### 8.1 RS485 interface - list of parameters

The implemented protocol complies with the PI-MBUS-300 Rev G specification of the Modicon company. The list of parameters of the serial link of the KD6 recorder:

- ID 0xEE
- meter address 1..247,
- baud rate 9.6, 19.2, 38.4, 57.6, 115.2 kbit / s,
- Modbus RTU operating mode,
- information unit 8N2, 8E1, 8O1, 8N1,
- maximum time to start the response 600 ms,
- maximum number of read registers in one query
  - 61 registers - 4 bytes,
  - 122 registers - 2 bytes,
- implemented functions - 03, 04, 06, 16, 17,
  - 03, 04 reading of registers,.
  - 06 one register record,
  - 16 record of n - registers,
  - 17 device identification, Factory

settings: address 1, baud rate 9.6 kbit / s, RTU 8N2 mode,

### 8.2 Examples of register reading and recording

#### Readout of n-registers (code 03h)

**Example 1.** Readout of 2 16-bit integer registers, starting from the register with the address 0FA0h (4000) - register values 10, 100.

Request

Device address	Function	Registry address		Number of Registers		CRC checksum
		B1	B0	B1	B0	
01	03	0F	A0	00	02	C7 3D

Response:

Device address	Function	Number of bytes	Value from the register 0FA0(4000)		Value from the register 0FA1(4001)		CRC checksum
			B1	B0	B1	B0	
01	03	04	00	0A	00	64	E4 6F

**Example 2.** Readout of 2 32-bit float registers as a combination of 2 16-bit registers, starting from the register with the address 1B58h (7000) - register values 10, 100.

## Request

Address	Function	Registry address		Number of device registers		CRC checksum
		B1	B0	B1	B0	
01	03	1B	58	00	04	C3 3E

## Response:

Device address	Function	Number of bytes	Value from the register 1B58(7000)		Value from the register 1B59(7001)		Value from the register 1B5A(7002)		Value from the register 1B5B(7003)		CRC checksum
			B3	B2	B1	B0	B3	B2	B1	B0	
01	03	08	41	20	00	00	42	C8	00	00	E4 6F

**Example 3.** Readout of 2 32-bit float registers as a combination of 2 16-bit registers, starting from the register with the address 1770h (6000) - register values 10, 100.

## Request

Device address	Function	Registry address		Number of device registers		CRC checksum
		B1	B0	B1	B0	
01	03	17	70	00	04	4066

## Response:

Device address	Function	Number of bytes	Value from the register 1770h(6000)		Value from the register 1770h(6000)		Value from the register 1772h(6002)		Value from the register 1772h(6002)		CRC checksum
			B1	B0	B3	B2	B1	B0	B3	B2	
01	03	08	00	00	41	20	00	00	42	C8	E4 6F

**Example 4.** Readout of 2 32-bit integer registers, starting from the register with the address 1D4Ch (7500) register values 10, 100.

## Request

Device address	Function	Registry address		Number of device registers		CRC checksum
		B1	B0	B1	B0	
01	03	1D	4C	00	02	03. B0

## Response:

Device address	Function	Number of bytes	Value from the register 1D4C(7500)				Value from the register 1D4D(7501)				CRC checksum
			B3	B2	B1	B0	B3	B2	B1	B0	
01	03	08	41	20	00	00	42	C8	00	00	E4 6F

**Readout of a single register (code 06h)**

**Example 5.** Recording the value 543 (0x021F) to the register 4000 (0x0FA0)

Request:

Device address	Function	Registry address		Register value		CRC checksum
		B1	B0	B1	B0	
01	06	0F	A0	02	1F	CA 54

**Response:**

Device address	Function	Registry address		Register value		CRC checksum
		B1	B0	B1	B0	
01	06	0F	A0	02	1F	CA 54

**Recording to n-registers (code 10h)**

**Example 6.** Recording of 2 registers starting from the register with the address 0FA3h (4003).

Recorded values 20, 2000.

Request

Device address	Function	Hi reg. address	Lo reg. address	Number of Hi reg. .	Number of Hi reg. .	Number of bytes	Value for reg. 0FA3 (4003)		Value for reg. 0FA4 (4004)		CRC checksum
							B1	B0	B1	B0	
01	10	0F	A3	00	02	04	00	14	07	D0	BB 9A

**Response:**

Device address	Function	Registry address		Number of device registers		CRC checksum
		B1	B0	B1	B0	
01	10	0F	A3	00	02	B2 FE

**Device identification report (code 11h) Example 7.** Device identification

Request:

Device address	Function	Checksum
01	11	C0 2C

## Response:

Address	Function	Number of bytes	ID	Device state	Information field about the device firmware version (e.g. "KD6-1.00 b-1.06" - KD6 device with firmware version 1.00 and bootloader version 1.06)	Checksum (CRC)
01	11	19	CF	FF	4E 34 33 20 2D 31 2E 30 30 20 20 20 20 20 20 62 2D 31 2E 30 36 20	E0 24

### 8.3 Connecting the 10/100-Base-T interface

To gain access to Internet services, it is required to connect the recorder to the network via the RJ45 socket located in the back / panel / part of the recorder, operating in accordance with the TCP / IP protocol.

Description of diodes of the recorder RJ45 socket:

- \_yellow LED - lights up when the recorder is correctly connected to the 100 Base-T Ethernet network, it is off when the recorder is not connected to the network or is connected to the 10-Base-T network.
- \_green LED - Tx / Rx, it is on when the recorder is sending and downloading data, it is on irregularly, when no data is sent, it is on continuously

It is recommended to use a twisted pair to connect the recorder to the network:

- U / FTP - twisted pair with each pair foiled,
- F / FTP - twisted pair with each pair foiled, additionally a cable in a foil screen,
- S / FTP (formerly SFTP) - twisted pair with each pair foiled, additionally a cable in a mesh screen,
- SF / FTP (formerly S-STP) - twisted pair with each pair, additionally foiled in a foil and mesh screen.

Twisted pair categories according to the European standard PN-EN 50173, minimum: class D (category 5) - for high-speed local networks, includes applications using the frequency band up to 100 MHz. For the Ethernet interface, use a twisted-pair STP (shielded) category 5 cable with RJ-45 plug with the colour of wires (according to table 13) in the following standard:

- EIA / TIA 568A for both pins at the so-called a straight connection of the KD6 to a network hub or switch,
- EIA / TIA 568A for the first pin and EIA / TIA 568B for the second pin at the so-called combined with interlacing (cross) used, among others. with direct connection of the KD6 recorder to the computer.



Wire no	Signal	Wire colour as per standard	
		EIA/TIA 568A	EIA/TIA 568B
1	TX+	White and green	White and orange
2	TX-	Green	Orange
3	RX+	White and orange	White and green
4	EPWR+	blue	blue
5	EPWR+	White and blue	White and blue
6	RX-	Orange	Green
7	EPWR-	White and brown	White and brown
8	EPWR-	brown	brown

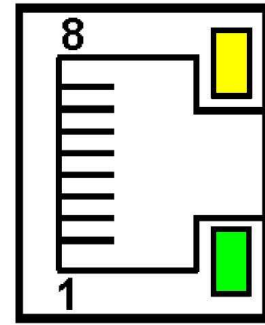

**Fig.32. View and pin numbering of the recorder RJ45 socket**

### 8.3.1. Web server

The KD6 recorder provides its own web server, which enables the remote monitoring of parameters displayed in individual screens (groups) of the recorder. In particular, the web site allows you to obtain information about the device (serial number, execution code, software version, bootloader version, software versions of modules located in slot X and slot Y,

The access to the web server is obtained by entering the recorder IP address in the web browser, e.g. [Http://192.168.1.030](http://192.168.1.030) (where 192.168.1.030 is the set recorder address). The standard port of the web server is "80". The server port can be changed by the user.

**Note:** For the proper functioning of the website, a browser with JavaScript support enabled and compatible with the XHTML 1.0 standard (all popular browsers, Internet Explorer version 8 or higher) is required.

### 8.3.1.1. General view

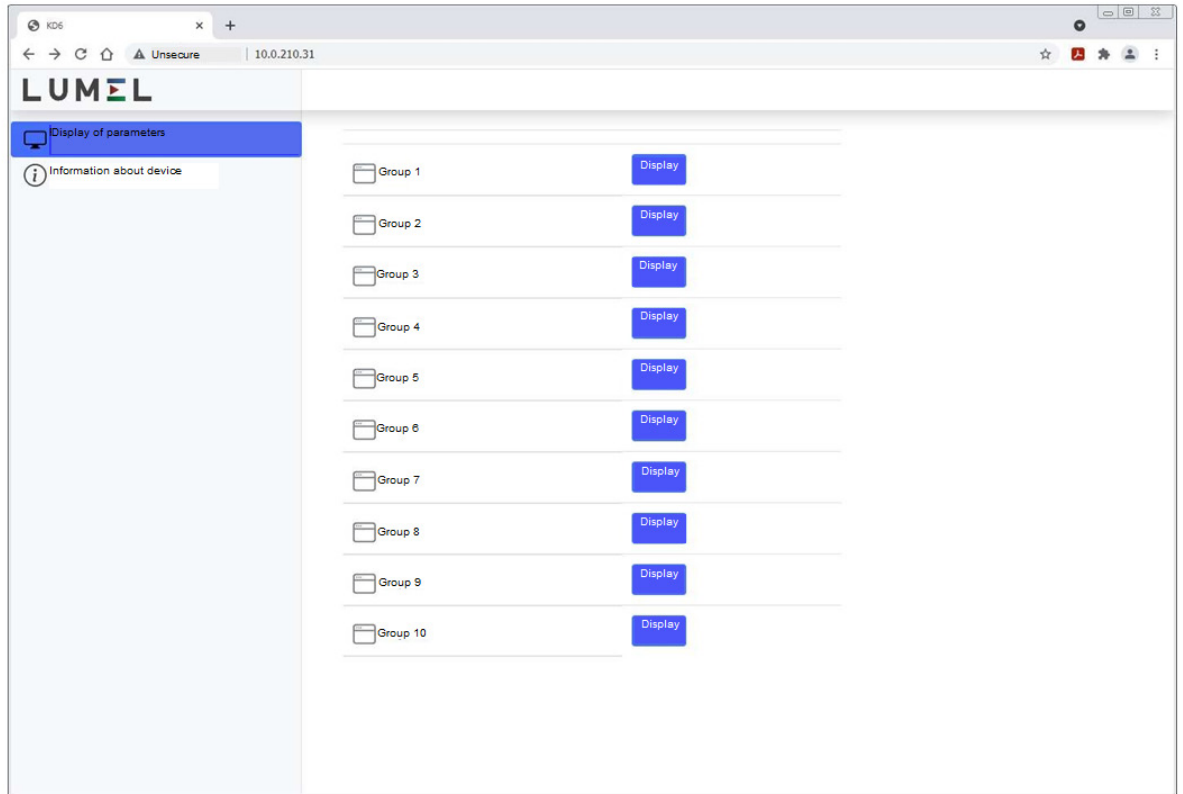

**Fig.33. View of the recorder website**

### 8.3.2 FTP server

The FTP file exchange protocol has been implemented in the KD6 recorders. The recorder acts as a server and it enables clients to access the internal memory of the recorder file system. The files can be accessed using a computer, tablet with an installed FTP client software or other device acting as an FTP client. For file transfer using the FTP protocol, the standard ports are “1025” - data port and “21” - command port. The user can change the ports used by the FTP protocol if necessary. Please note that the configuration of the server and FTP client ports must be the same.

The FTP client software must run in passive mode. In passive mode, the connection is fully

compiled by the client (the client decides about the choice of the data port). For file transmission with the recorder, it is possible to use a maximum of one connection at the same time, therefore the maximum number of connections in the client software should be limited to 1.

### **8.3.2.1 *Selecting the FTP user (the possibility to change the password can be added to the recorder website)***

The recorder has two user accounts for the FTP server protected with individual passwords:

- user: “**Admin**”, password: “**Admin**” - access to recording and reading of files
- user: “**User**”, password: “**Passftp**” - read-only access to the reading of archived files.

The name of the FTP server users cannot be changed, but the password for each user can be changed - it is recommended to change the passwords for security reasons. The password can be changed only through the website in the “Ethernet” parameter group. Passwords consist of 8 characters maximum. If the password is lost - which will make it impossible to use the FTP server, restore the default parameters of the Ethernet interface, e.g. from the menu: Settings → Factory settings → Yes, or by entering the value “1” in the register 4152. All standard meter parameters will be restored, including Ethernet interface parameters (acc. to table 9) and passwords for FTP server users:

user “**admin**” → password: “**Admin**”; user “**user**” → password “**passftp**”.

FileZilla can be an example of an FTP client. By entering the recorder IP address in the address field, you can view and download the archive files.

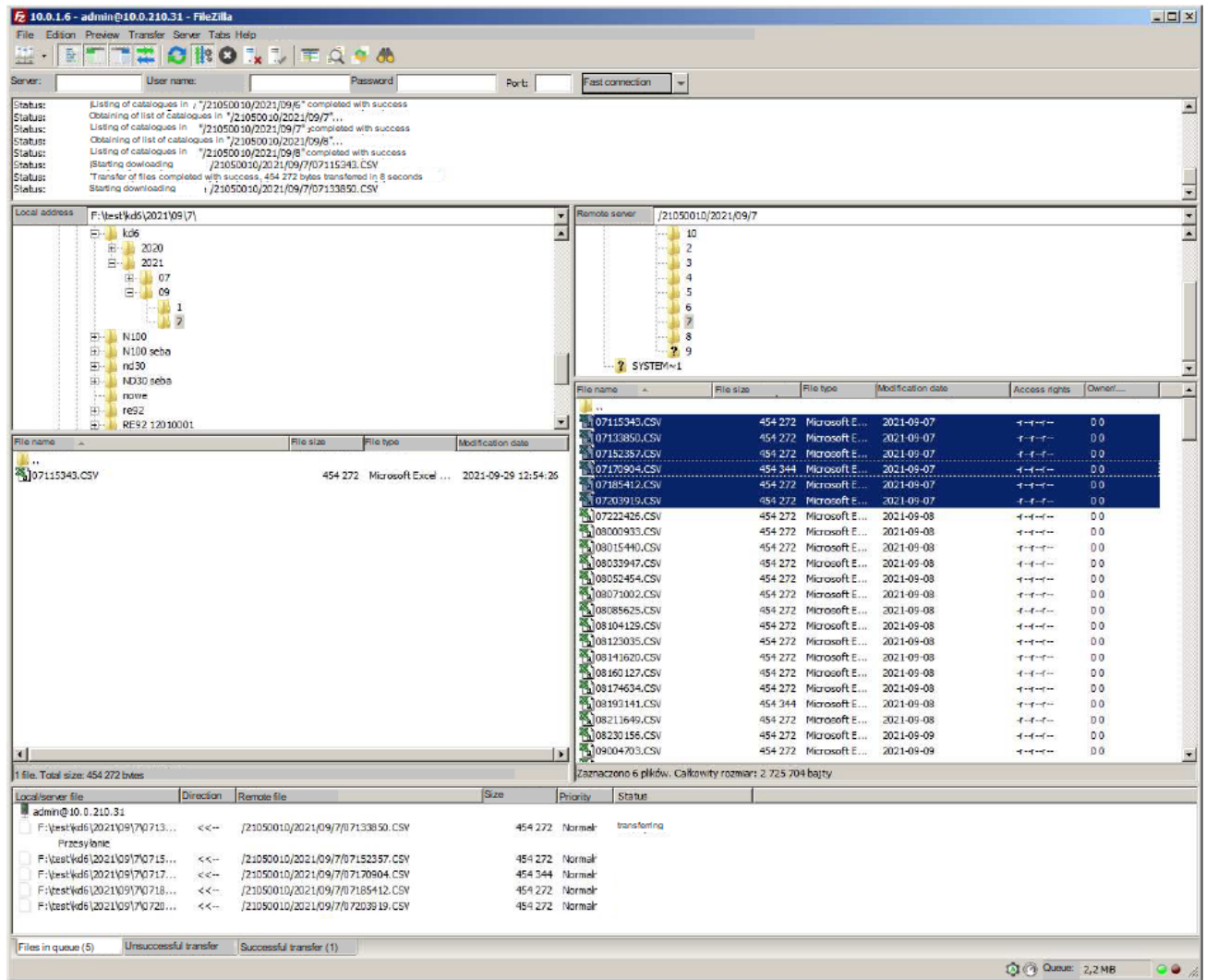

Fig.34 View of the FTP session called in FileZilla

### 8.3.3 Modbus TCP/IP

The KD6 recorder enables the access to internal registers through the Ethernet interface and Modbus TCP / IP protocol. To establish the connection, it is necessary to set the unique IP address in the network for the recorder and to set the connection parameters listed in the table 14.

Table 14.

Register	Description	default value
4146	Device address for Modbus TCP / IP protocol	1
4147	Modbus TCP port number	502
4145	Modbus TCP / IP service port closing time [s]	60
4144	Maximum number of simultaneous connections to the Modbus TCP / IP service	4

The device address is the device address for the Modbus TCP / IP protocol and is not the same as the address value for the Modbus RS485 protocol (Address in the Modbus network, register 4100). By setting the “Device address for Modbus TCP / IP” parameter of the recorder to the value of “255” the recorder will skip the address analysis in the Modbus protocol frame (broadcast mode).

## 9 Map of the KD6 recorder registers

In the KD6 recorder, data are placed in 16-bit and 32-bit registers. Process variables and recorder parameters are placed in the address space of registers in a manner dependent on the type of the variable value. Bits in the 16-bit register are numbered from the youngest to the oldest (b0-b15). 32-bit registers include numbers of float type in the IEEE-754 standard. Sequence of 3210 bytes - the oldest one is sent as the first.

Table 15.

Address range	Value type	Description
4000– 4159	Integer (16 bits)	Registers for the general configuration of the recorder and archiving configuration. Value placed in one 16-bit register. Registers for recording and reading
4400– 4485	Integer (16 bits)	Information registers of the recorder. Value put into one 16-bit register. Read-only registers
5000- 8105	Integer (16 bits)	Configuration registers Modbus Master: Value placed in one 16-bit register. Registers for recording and reading
8110- 9360	Integer (16 bits)	Groups configuration registers Value placed in one 16-bit register. Registers for recording and reading
9370- 10879	Integer (16 bits)	Inputs and Outputs configuration registers Value placed in one 16-bit register. Registers for recording and reading
10900- 11203	Integer (16 bits)	Logical channels configuration registers Value put into one 16-bit register. Registers for recording and reading
11300- 11699	Integer (16 bits)	Maths functions configuration registers Value put into one 16-bit register. Registers for recording and reading
11800- 12999	Integer (16 bits)	Scaling functions configuration registers Value put into one 16-bit register. Registers for recording and reading
13800- 14099	Integer (16 bits)	Alarm functions configuration registers Value placed in one 16-bit register. Registers for recording and reading
14300– 14411	float (2x16 bits)	Registers with inputs/outputs measurement values. Value put into one two 16-bits registers. Read-only registers
14500– 14619	float(2x 16 bits)	Registers with channels measurement values. Value placed in two 16-bit registers. Read-only registers

### General configuration registers and archiving registers

Table 16

Register address	Operations	Range	Description	By default
4000	RW	0...9999	Security - password	0
4001	RW		reserved	
<b>Group 1– archiving</b>				
4002	RW	0..5	Group 1, Archiving type 0 - manually disabled 1 - manually activated 2 - archiving below the lower archiving threshold 3 - archiving above the upper archiving threshold 4 - archiving between thresholds 5 - archiving beyond Lo Hi thresholds	0
4003	RW	0...59	Group 1, channel number triggering archiving	0
4004	RW	1 .. 3600	Group 1, archiving interval in seconds	1
4005	RW	-2147400000	Group 1, archiving lower threshold Lo	-9999999
4006	RW	.. 2147400000	Group 1, archiving lower threshold Hi	
4007	RW	-2147400000	Group 1, archiving upper threshold Lo	9999999
4008	RW	.. 2147400000	Group 1, archiving upper threshold Hi	
4009			reserved	

4010			reserved	
------	--	--	----------	--

Register address	Operations	Range	Description	By default
<b>Group 2– archiving</b>				
4011...4019			Range of modifications as in registers 4005...4013	
<b>Group 3– archiving</b>				
4020...4028			Range of modifications as in registers 4005...4013	
<b>Group 4– archiving</b>				
4029...4037			Range of modifications as in registers 4005...4013	
<b>Group 5– archiving</b>				
4038...4046			Range of modifications as in registers 4005...4013	
<b>Group 6– archiving</b>				
4047...4055			Range of modifications as in registers 4005...4013	
<b>Group 7– archiving</b>				
4056...4064			Range of modifications as in registers 4005...4013	
<b>Group 8– archiving</b>				
4065...4073			Range of modifications as in registers 4005...4013	
<b>Group 9– archiving</b>				
4074...4082			Range of modifications as in registers 4005...4013	
<b>Group 10– archiving</b>				
4083...4091			Range of modifications as in registers 4005...4013	
4092			reserved	
4093	RW	0.1	Keep the exported files on the device	0
4094	RW	0.1	Export files to external memory 0 - do not export, 1 - export	0
4095	RW	0.1	Copying the archive to the file archive memory “1” - copy the archive to the file archive memory / only those records that have been registered since the last copying /	0
4096	RW	0.1	Deleting the entire internal archive 0 - no reaction, 1 - archive deleting	0
4097	RW	0 .. 2	Field separator 0 - comma, 1- semicolon; 2 - tabulator “	,
4098	RW	0.1	Decimal separator 0 - dot‘.’ 1 - comma ‘,’	.
4099			reserved	
4100	RW	1..247	Address in Modbus net	1
4101	RW	0..3	Transmission mode: 0->8n2, 1->8e1, 2->8o1, 3->8n1	3
4102	RW	0..4	Baud rate: 0->9600 1->19200, 2->38400, 3->57600, 4->115200	4
4103	RW		reserved	
4104	RW	0.1	Update the modification of transmission data:	0
4105			reserved	
4106			reserved	
4107			reserved	
4108			reserved	
4109			reserved	
4110			reserved	
4111			reserved	
4112			reserved	
4113			reserved	
4114			reserved	
4115			reserved	
4116			reserved	
4117	RW	0...65535	third and second bytes (B3.B2) of the time server address format address: B3.B2.B1.B0	
4118	RW	0...65535	First and zero byte (B1.B0) of the time server address, address format: B3.B2.B1.B0	
4119	RW	0.1	Local time offset from UTC 0 - positive + 1 - negative -	0

Group 10– archiving				
4120	RW	0...12	Hourly offset of local time from UTC time	1
4121	RW	0...59	Minute offset of local time from UTC time	0
4122	RW	0, 1	Seasonal time change 0 - Yes 1 - No	0
4123	RW	0, 1	Synchronize RTC time from time server 0 - no action 1 - sync now	0
4124			reserved	
4125			reserved	
4126			reserved	
4127			reserved	
4128			reserved	
4129			reserved	
4130	RW	0.1	Enabling / disabling the DHCP client (support for the automatic acquisition of IP protocol parameters of the meter Ethernet interface from external DHCP servers within the same LAN local network) 0 - DHCP service disabled - you must manually configure the IP address and the subnet mask of the recorder; 1- DHCP service enabled, the recorder will automatically receive the IP address, subnet mask and gateway address from the DHCP server after powering on, the gateway address will be the address of the server that assigned the parameters to the recorder,	1
4131	RW	0...65535	Third and second byte (B3.B2) of the recorder IP address, IPv4 address format: B3.B2.B1.B0	49320 (0xC0A8 = 192.168)
4132	RW	0...65535	First and zero byte (B1.B0) of the IP of recorder address, IPv4 address format: B3.B2.B1.B0	356 (0x0164 = 1.100)
4133	RW	0...65535	Third and second byte (B3.B2) of the recorder subnet mask, mask format: B3.B2.B1.B0	65535
4134	RW	0...65535	The first and zero byte (B1.B0) of the recorder subnet mask, mask format: B3.B2.B1.B0	65280
4135	RW	0...65535	Third and second byte (B3.B2) of the recorder default gateway, gateway address format: B3.B2.B1.B0	49320
4136	RW	0...65535	First and zero byte (B1.B0) of the recorder default gateway, gateway address format B3.B2.B1.B0	257
4137	RW	0...65535	Third and second byte (B3.B2) of the DNS recorder address, IPv4 address format: B3.B2.B1.B0	0x0808=8.8
4138	RW	0...65535	First and zero byte (B1.B0) of the DNS recorder address, IPv4 address format: B3.B2.B1.B0	0x0808=8.8
4139	RW		reserved	
4140	RW		reserved	
4141	RW	0 .. 2	Ethernet interface baud rate:: 0 - automatic selection of the baud rate: 1 - 10 Mb / s 2 – 100 Mb/s	0
4142	RW	20...65535	FTP server command port number	21
4143	RW	20...65535	FTP server data port number	1025
4144	RW	1...4	The maximum number of simultaneous connections to the Modbus TCP / IP service	1
4145	RW	10...600	Modbus TCP / IP service port closing time, value expressed in seconds	60
4146	RW	0...255	Device address for Modbus TCP / IP protocol	1
4147	RW	0...65535	Modbus TCP port number	502
4148	RW	80...65535	Web server port number	80

4149	RW	0.1	Saving new parameters of the Ethernet interface and re-initializing the interface	0
------	----	-----	---	---

Group 10– archiving				
			0 - without changes, 1 - memorizing new parameters and rebooting the Ethernet interface,	
4150	RW	0..2	Menu language: 0-ENG, 1-PL, 2-DE	0
4151	RW	0.1	reserved	0
4152	RW	0.1	Saving standard parameters including Ethernet,	0
4153	RW	0..59	Seconds	0
4154	RW	0...2359	Hour * 100 + Minutes	0
4155	RW	101...1231	Month * 100 + day	101
4156	RW	2015...2077	Year	2015
4157	RW	0.1	Password disabled / enabled	0
4158	RW		reserved	
4159	RW		reserved	

Information registers of the recorder Table 17

Register address	Operations	Range	Description	By default
4400	R		reserved	
4401	R	0..65535	ID	EE
4402	R	0..65535	Recorder bootloader version x 100	-
4403	R	0..65535	Recorder software version x100	-
4404	R		reserved	
4405	R	0..65535	Execution code (the first 3 digits of the KD6 code - X X X xx x x)	-
4406	R	0..65535	Execution code (the first 5 digits of the KD6 code - x x x_ XX XX)	-
4407	R	0..65535	Slot 1 card identifier (according to the code 0x XXxx, detected 0x xxXX)	0x0000
4408	R	0..65535	Slot 2 card identifier (according to the code 0x XXxx, detected 0x xxXX)	0x0000
4409	R	0..65535	Card software version in slot 1 x100	-
4410	R	0..65535	Card software version in slot 2 x100	-
4411	R	0..65535	Seventh and sixth bytes (B7.B6) of the serial number, B7:B6:B5:B4:B3:B2:B1:B0 format	-
4412	R	0..65535	Fifth and fourth bytes (B5.B4) of the serial number, B7:B6:B5:B4:B3:B2:B1:B0 format	-
4413	R	0..65535	Third and second byte (B3.B2) of the serial number B7:B6:B5:B4:B3:B2:B1:B0 format	-
4414	R	0..65535	First and zero byte (B1.B0) of the serial number, B7:B6:B5:B4:B3:B2:B1:B0 format	-
4415	R	0..65535	Status 1 register - description below	0
4416	R	0..65535	Status 2 register - description below	0
4417	R	0..65535	Status 3 register - description below	0
4418	R	0..65535	Status 4 register - description below	0
4419	R	0..65535	Status 5 register - description below	0
4420	R	0..65535	Status 6 register - description below	0
4421	R	0...65535	Fifth and fourth byte (B5.B4) of the MAC recorder address, B5: B4: B3: B2:B1: B0 format	-
4422	R	0...65535	Third and second byte (B3.B2) of the MAC recorder address, B5:B4:B3:B2:B1:B0 format	-
4423	R	0...65535	First and zero byte (B1.B0) of the MAC recorder address, B5:B4:B3:B2:B1:B0 format	-
4424	R	0...65535	State 7 register - description below	0
4425	R	0..65535	Status of alarm 1	0
4426	R	0..65535	Status of alarm 2	0
4427	R	0..65535	Status of alarm 3	0
4428	R	0..65535	Status of alarm 4	0
4429	R	0..65535	Status of alarm 5	0



4430	R	0..65535	Status of alarm 6	0
4431	R	0..65535	Status of alarm 7	0
4432	R	0..65535	Status of alarm 8	0
4433	R	0..65535	Status of alarm 9	0
4434	R	0..65535	Status of alarm 10	0
4435	R	0..65535	Status of alarm 11	0
4436	R	0..65535	Status of alarm 12	0
4437	R	0..65535	Status of alarm 13	0
4438	R	0..65535	Status of alarm 14	0
4439	R	0..65535	Status of alarm 15	0
4440	R	0..65535	Status of alarm 16	0
4441	R	0..65535	Status of alarm 17	0
4442	R	0..65535	Status of alarm 18	0
4443	R	0..65535	Status of alarm 19	0
4444	R	0..65535	Status of alarm 20	0
4445	R	0..1000	Filling the archive files in %	0
4446	R	0..1000	Percentage of progress when copying the internal archive to the files archive %	0
4447	R			0
..				
4461	R			
4462	R			0
4463	R			0
4464	R			0
4465	R			0
4466	R			0
4467	R			0
4468	R		reserved	0
4469	R			0
4470	R			0
4471	R			0
4472	R			0
4473	R			0
4474	R			0
4475	R			0
4476	R			0
4477	R			0
4478	R			0
4479	R			0
4480	R			0
4481	R			0
4482	R			0
4483	R			0
4484	R			0
4485	R			0

**Device Status 1 Register (address 4415, R):**

Bit 15 - "1" - FRAM memory damage.	Bit 7 - "1" - error in scaling function configuration registers
Bit 14 - "1" - error in channel configuration registers	Bit 6 - reserved
Bit 13 - "1" - error in card configuration registers configuration registers	Bit 5 - "1" - error in alarm functions
Bit 12 - "1" - error in modbus master configuration registers	Bit 4 - "1" - card inserted in Slot 2
Bit 11 - "1" - error in configuration registers.	Bit 3 - "1" - card inserted in Slot 1
Bit 10 - "1" - error in group configuration registers	Bit 2 - "1" - presence of USB, Ethernet and RS485
Bit 9 - "1" - calibration error	Bit 1 - "1" - date or time not set / RTC time battery used
Bit 8 - "1" - error in mathematical functions configuration registers	Bit 0 - "1" - external memory connected to the UBS

**Status 2 Register - (address 4416, R):**

Bit 15 - "1" - reserved	Bit 7 - "1" - reserved
Bit 14 - "1" - reserved	Bit 6 - "1" - reserved
Bit 13 - "1" - reserved	Bit 5 - "1" - reserved
Bit 12 - "1" - Slot 2 a card inconsistent with the execution code was detected	Bit 4 - "1" - Slot 1 a card inconsistent with the execution code was detected
Bit 11 - "1" - Slot 2 - no card calibration	Bit 3 - "1" - Slot 1 - no card calibration
Bit 10 - "1" - Slot 2 - no communication with the card	Bit 2 - "1" - Slot 1 - no communication with the card
Bit 9 - "1" - Slot 2 the card is waiting in the bootloader mode	Bit 1 - "1" - Slot 1 the card is waiting in the bootloader mode
Bit 8 - "1" - Slot 2 the card is in the programming mode	Bit 0 - "1" - Slot 1 the card is in the programming mode

**Status 3 Register - (address 4417, R): File archive status**

Bit 15 - connected	Bit 7 - copying the internal memory to the file archive from the 4th archiving group,
Ethernet Bit 14 - reserved	Bit 6 - copying the internal memory to the file archive from the 3rd archiving group,
Bit 13 - copying the internal memory to the file archive from the 10th archiving group,	Bit 5 - copying the internal memory to the file archive from the 2nd archiving group,
Bit 12 - copying the internal memory to the file archive from the 9th archiving group,	Bit 4 - copying the internal memory to the file archive from the 1st archiving group,
Bit 11 - copying the internal memory to the file archive from the 8th archiving group,	Bit 3 - File archive full, (less than 14 days until the file archive is full at 1 second interval)
Bit 10 - copying the internal memory to the file archive from the 7th archiving group,	Bit 2 - File archive full in 70%
Bit 9 - copying the internal memory to the file archive from the 6th archiving group,	Bit 1 - File archive initialized correctly. Bit 0 - File archive system error
Bit 8 - copying the internal memory to the file archive from the 5th archiving group,	

**Status 4 Register - (address 4418, R): Archiving status p. 1**

Bit 15 - Export of files to external memory (USB)	Bit 7 - "1" - Archiving group 8 is on,
Bit 14 - "0" - Export of files to external memory (USB) disabled	Bit 6 - "1" - Archiving group 7 is on,
"1" - Enabled export of files to external memory (USB)	Bit 5 - "1" - Archiving group 6 is on,
Bit 13 - reserved,	Bit 4 - "1" - Archiving group 5 is on,
Bit 12 - reserved,	Bit 3 - "1" - Archiving group 4 is on,
Bit 11 - reserved,	Bit 2 - "1" - Archiving group 3 is on,
Bit 10 - reserved,	Bit 1 - "1" - Archiving group 2 is on,,
Bit 9 - "1" - Archiving group 10 is on,	Bit 0 - "1" - Archiving group 1 is on,
Bit 8 - "1" - Archiving group 9 is on,	

**State 5 Register - (address 4419, R): Archiving status p. 2**

Bit 15 - reserved,	Bit 7 - "0" - waiting for the meeting of archiving conditions,
Bit 14 - reserved,	"1" - archiving in the 8th archiving group,
Bit 13 - reserved,	Bit 6 - "0" - waiting for the meeting of archiving conditions,
Bit 12 - reserved,	"1" - archiving in the 7th archiving group,
Bit 11 - reserved,	Bit 5 - "0" - waiting for the meeting of archiving conditions,
Bit 10 - reserved,	"1" - archiving in the 6th archiving group,
Bit 9 - "0" - waiting for the meeting of archiving conditions,	Bit 4 - "0" - waiting for the meeting of archiving conditions,
"1" - archiving in the 10th archiving group,	"1" - archiving in the 5th archiving group,
Bit 8 - "0" - waiting for the meeting of archiving conditions,	Bit 3 - "0" - waiting for the meeting of archiving conditions,
"1" - archiving in the 9th archiving group,	"1" - archiving in the 4th archiving group,
	Bit 2 - "0" - waiting for the meeting of archiving conditions,
	"1" - archiving in the 3rd archiving group,
	Bit 1 - "0" - waiting for the meeting of archiving conditions,
	"1" - archiving in the 2nd archiving group,
	Bit 0 - "0" - waiting for the meeting of archiving conditions,
	"1" - archiving in the 1st archiving group,

## User's manual

Modbus Master configuration registers Table18

Register address	Operations	Range	Description	By default
5000	RW	0..1	Work mode 0- slave; 1 – master	0
5001	RW	0x0000...0x03FF	Master n on / off bit 0 - 0- master 1 disabled, 1- master 1 enabled bit 1 - 0- master 2 disabled, 1- master 1 enabled ... bit 9 - 0- master 10 disabled, 1- master 10 enabled	1
5002	RW	1...247	Slave device address (Operating mode = slave)	1
5003	RW	0...3	Transmission mode: 0->8n2, 1->8e1, 2->8o1, 3->8n1	3
5004	RW	0...4	Baud rate:: 0->9600 1->19200, 2->38400, 3->57600, 4->115200	4
5005	RW	0...10	The number of repetitions before an error is reported	0
<b>Master 1</b>				
5006	RW	1...247	Slave device address	1
5007	RW	1...10	Number of registers to be read	1
5008	RW	0x0000...0xFFFF	First register address	4000
5009	RW	0...9	Register type 0 – char, 1 – uchar, 2 – int, 3 - uint, 4 – long, 5 – ulong, 6 – float 1234, 7 – float 2143, 8 – float 4321, 9 – float 3412	3
5010	RW	0...1	Reading function 0 – 0x03, 1 - 0x04	0
5011	RW	100...10000 [ms]	Timeout for a response	1000
5012	RW	100...10000 [ms]	Polling frequency (Interval)	1000
5013	RW	1..2	Number of bits 1 - 32 bits 2 - 16 bits	2
5014			reserved	
5015			reserved	
<b>Master 1 – register 1</b>				
5016	RW	1...2	Signal type 1 - analogue, 2 - binary (for value = 0 FALSE, for value! = 0 TRUE)	1
5017	RW	-2147400000	Min range Lo	-9999999
5018	RW	2147400000	Min range Hi	
5019	RW	-2147400000	Max range Lo	9999999
5020	RW	2147400000	Max range Hi	
5021	RW	0...2	Logical shift 0– None ,1- >>right ,2- <<left	0
5022	RW	1...31	N bites logical shift	7
5023	RW	0x0000...0xFFFF	Lo bitmask	0xFFFF
5024	RW	0x0000...0xFFFF	Hi bitmask (for Register type > 3)	0xFFFF
5025	RW	0, 0x2020..0x7A7A	OFF tag ASCII 2 and 1 characters (for Signal type = 1)	0x4F46
5026	RW	0, 0x2020..0x7A7A	OFF tag ASCII 4 and 3 characters	0x4620
5027	RW	0, 0x2020..0x7A7A	OFF label ASCII 6 and 5 characters	0x2020
5028	RW	0, 0x2020..0x7A7A	OFF label ASCII 8 and 7 characters	0x2020
5029	RW	0, 0x2020..0x7A7A	ON tag ASCII 2 and 1 characters (for Signal type = 1)	0x4F4E
5030	RW	0, 0x2020..0x7A7A	ON tag ASCII 4 and 3 characters	0x2020
5031	RW	0, 0x2020..0x7A7A	ON tag ASCII 6 and 5 characters	0x2020
5032	RW	0, 0x2020..0x7A7A	ON tag ASCII 8 and 7 characters	0x2020
5033	RW	0, 0x2020..0x7A7A	Register 1– name ASCII 2 and 1 characters	0x4D4D „MM”
5034	RW	0, 0x2020..0x7A7A	Register 1– name ASCII 4 and 3 characters	0x522D „R-”
5035	RW	0, 0x2020..0x7A7A	Register 1– name ASCII 6 and 5 characters	0x6765„ge

## User's manual

5036	RW	0, 0x2020..0x7A7A	Register 1– name ASCII 8 and 7 characters	0x0031 1”
5037	RW	0, 0x2020..0x7A7A	Register 1– name ASCII 10 and 9 characters	0x0000
5038	RW	0, 0x2020..0x7A7A	Register 1– name ASCII 12 and 11 characters	0x0000
5039	RW	0, 0x2020..0x7A7A	Unit name ASCII 2 and 1 characters	0x2020
5040	RW	0, 0x2020..0x7A7A	Unit name ASCII 4 and 3 characters	0x2020
5041	RW	0, 0x2020..0x7A7A	Unit name ASCII 6 and 5 characters	0x2020
5042	RW	0, 0x2020..0x7A7A	Unit name ASCII 8 and 7 characters	0x2020
5043			reserved	
5044			reserved	
5045			reserved	
<b>Master 1 – register 2</b>				
5046...5075			Range of changes as in registers 5016 ... 5045	
<b>Master 1 – register 3</b>				
5076...5105			Range of changes as in registers 5016 ... 5045	
<b>Master 1 – register 4</b>				
5106...5135			Range of changes as in registers 5016 ... 5045	
<b>Master 1 – register 5</b>				
5136...5165			Range of changes as in registers 5016 ... 5045	
<b>Master 1 – register 6</b>				
5166...5195			Range of changes as in registers 5016 ... 5045	
<b>Master 1 – register 7</b>				
5196...5225			Range of changes as in registers 5016 ... 5045	
<b>Master 1 – register 8</b>				
5226...5255			Range of changes as in registers 5016 ... 5045	
<b>Master 1 – register 9</b>				
5256...5285			Range of changes as in registers 5016 ... 5045	
<b>Master 1 – register 10</b>				
5286...5315			Range of changes as in registers 5016 ... 5045	
<b>Master 2</b>				
5316...5325			Range of changes as in registers 5006 ... 5015	
<b>Master 2 – register 1</b>				
5326...5355			Range of changes as in registers 5016 ... 5045	
<b>Master 2 – register 2</b>				
5356...5385			Range of changes as in registers 5016 ... 5045	
<b>Master 2 – register 3</b>				
5386...5415			Range of changes as in registers 5016 ... 5045	
<b>Master 2 – register 4</b>				
5416...5445			Range of changes as in registers 5016 ... 5045	
<b>Master 2 – register 5</b>				
5446...5475			Range of changes as in registers 5016 ... 5045	
<b>Master 2 – register 6</b>				
5476...5505			Range of changes as in registers 5016 ... 5045	
<b>Master 2 – register 7</b>				
5506...5535			Range of changes as in registers 5016 ... 5045	
<b>Master 2 – register 8</b>				
5536...5565			Range of changes as in registers 5016 ... 5045	
<b>Master 2 – register 9</b>				
5566...5595			Range of modifications as in registers 5016...5045	
<b>Master 2 – register 10</b>				
5596...5625			Range of changes as in registers 5016 ... 5045	
<b>Master 3</b>				
5626...5635			Range of modifications as in registers 5006...5015	
<b>Master 3 – register 1</b>				
5636...5665			Range of modifications as in registers 5016...5045	
<b>Master 3 – register 2</b>				
5666...5695			Range of modifications as in registers 5016...5045	
<b>Master 3 – register 3</b>				

## User's manual

5696...5725	Range of modifications as in registers 5016...5045	
<b>Master 3 – register 4</b>		
5726...5755	Range of modifications as in registers 5016...5045	
<b>Master 3 – register 5</b>		
5756...5785	Range of modifications as in registers 5016...5045	
<b>Master 3 – register 6</b>		
5786...5815	Range of modifications as in registers 5016...5045	
<b>Master 3 – register 7</b>		
5816...5845	Range of modifications as in registers 5016...5045	
<b>Master 3 – register 8</b>		
5846...5875	Range of modifications as in registers 5016...5045	
<b>Master 3 – register 9</b>		
5876...5905	Range of changes as in registers 5016 ... 5045	
<b>Master 3 – register 10</b>		
5906...5935	Range of changes as in registers 5016 ... 5045	
<b>Master 4</b>		
5936...5945	Range of changes as in registers 5006 ... 5015	
<b>Master 4 – register 1</b>		
5946...5975	Range of changes as in registers 5016 ... 5045	
<b>Master 4 – register 2</b>		
5976...6005	Range of changes as in registers 5016 ... 5045	
<b>Master 4 – register 3</b>		
6006...6035	Range of changes as in registers 5016 ... 5045	
<b>Master 4 – register 4</b>		
6036...6065	Range of changes as in registers 5016 ... 5045	
<b>Master 4 – register 5</b>		
6066...6095	Range of changes as in registers 5016 ... 5045	
<b>Master 4 – register 6</b>		
6096...6125	Range of changes as in registers 5016 ... 5045	
<b>Master 4 – register 7</b>		
6126...6155	Range of changes as in registers 5016 ... 5045	
<b>Master 4 – register 8</b>		
6156...6185	Range of changes as in registers 5016 ... 5045	
<b>Master 4 – register 9</b>		
6186...6215	Range of changes as in registers 5016 ... 5045	
<b>Master 4 – register 10</b>		
6216...6245	Range of changes as in registers 5016 ... 5045	
<b>Master 5</b>		
6246...6255	Range of changes as in registers 5006 ... 5015	
<b>Master 5 – register 1</b>		
6256...6285	Range of changes as in registers 5016 ... 5045	
<b>Master 5 – register 2</b>		
6286...6315	Range of changes as in registers 5016 ... 5045	
<b>Master 5 – register 3</b>		
6316...6345	Range of changes as in registers 5016 ... 5045	
<b>Master 5 – register 4</b>		
6346...6375	Range of changes as in registers 5016 ... 5045	
<b>Master 5 – register 5</b>		
6376...6405	Range of changes as in registers 5016 ... 5045	
<b>Master 5 – register 6</b>		
6406...6435	Range of changes as in registers 5016 ... 5045	
<b>Master 5 – register 7</b>		
6436...6465	Range of changes as in registers 5016 ... 5045	
<b>Master 5 – register 8</b>		
6466...6495	Range of changes as in registers 5016 ... 5045	
<b>Master 5 – register 9</b>		
6496...6525	Range of changes as in registers 5016 ... 5045	
<b>Master 5 – register 10</b>		
6526...6555	Range of changes as in registers 5016 ... 5045	
<b>Master 6</b>		

## User's manual

6556...6565	Range of changes as in registers 5006 ... 5015	
<b>Master 6 – register 1</b>		
6566...6595	Range of changes as in registers 5016 ... 5045	
<b>Master 6 – register 2</b>		
6596...6625	Range of changes as in registers 5016 ... 5045	
<b>Master 6 – register 3</b>		
6626...6655	Range of changes as in registers 5016 ... 5045	
<b>Master 6 – register 4</b>		
6656...6685	Range of changes as in registers 5016 ... 5045	
<b>Master 6 – register 5</b>		
6686...6715	Range of changes as in registers 5016 ... 5045	
<b>Master 6 – register 6</b>		
6716...6745	Range of changes as in registers 5016 ... 5045	
<b>Master 6 – register 7</b>		
6746...6775	Range of changes as in registers 5016 ... 5045	
<b>Master 6 – register 8</b>		
6776...6805	Range of changes as in registers 5016 ... 5045	
<b>Master 6 – register 9</b>		
6806...6835	Range of changes as in registers 5016 ... 5045	
<b>Master 6 – register 10</b>		
6836...6865	Range of changes as in registers 5016 ... 5045	
<b>Master 7</b>		
6866...6875	Range of changes as in registers 5006 ... 5015	
<b>Master 7 – register 1</b>		
6876...6905	Range of changes as in registers 5016 ... 5045	
<b>Master 7 – register 2</b>		
6906...7035	Range of changes as in registers 5016 ... 5045	
<b>Master 7 – register 3</b>		
6936...7065	Range of changes as in registers 5016 ... 5045	
<b>Master 7 – register 4</b>		
6966...7095	Range of changes as in registers 5016 ... 5045	
<b>Master 7 – register 5</b>		
6996...7125	Range of changes as in registers 5016 ... 5045	
<b>Master 7 – register 6</b>		
7026...7155	Range of changes as in registers 5016 ... 5045	
<b>Master 7 – register 7</b>		
7056...7185	Range of changes as in registers 5016 ... 5045	
<b>Master 7 – register 8</b>		
7086...7215	Range of changes as in registers 5016 ... 5045	
<b>Master 7 – register 9</b>		
7116...7245	Range of changes as in registers 5016 ... 5045	
<b>Master 7 – register 10</b>		
7146...7275	Range of changes as in registers 5016 ... 5045	
<b>Master 8</b>		
7176...7185	Range of changes as in registers 5006 ... 5015	
<b>Master 8 – register 1</b>		
7186...7215	Range of changes as in registers 5016 ... 5045	
<b>Master 8 – register 2</b>		
7216...7245	Range of changes as in registers 5016 ... 5045	
<b>Master 8 – register 3</b>		
7246...7275	Range of changes as in registers 5016 ... 5045	
<b>Master 8 – register 4</b>		
7276...7305	Range of changes as in registers 5016 ... 5045	
<b>Master 8 – register 5</b>		
7306...7335	Range of changes as in registers 5016 ... 5045	
<b>Master 8 – register 6</b>		
7336...7365	Range of changes as in registers 5016 ... 5045	
<b>Master 8 – register 7</b>		
7366...7395	Range of changes as in registers 5016 ... 5045	
<b>Master 8 – register 8</b>		

## User's manual

7396...7425	Range of changes as in registers 5016 ... 5045	
<b>Master 8 – register 9</b>		
7426...7455	Range of changes as in registers 5016 ... 5045	
<b>Master 8 – register 10</b>		
7456...7485	Range of changes as in registers 5016 ... 5045	
<b>Master 9</b>		
7486...7495	Range of changes as in registers 5006 ... 5015	
<b>Master 9 – register 1</b>		
7496...7525	Range of changes as in registers 5016 ... 5045	
<b>Master 9 – register 2</b>		
7526...7555	Range of changes as in registers 5016 ... 5045	
<b>Master 9 – register 3</b>		
7556...7585	Range of changes as in registers 5016 ... 5045	
<b>Master 9 – register 4</b>		
7586...7615	Range of changes as in registers 5016 ... 5045	
<b>Master 9 – register 5</b>		
7616...7645	Range of changes as in registers 5016 ... 5045	
<b>Master 9 – register 6</b>		
7646...7675	Range of changes as in registers 5016 ... 5045	
<b>Master 9 – register 7</b>		
7676...7705	Range of changes as in registers 5016 ... 5045	
<b>Master 9 – register 8</b>		
7706...7735	Range of changes as in registers 5016 ... 5045	
<b>Master 9 – register 9</b>		
7736...7765	Range of changes as in registers 5016 ... 5045	
<b>Master 9 – register 10</b>		
7766...7795	Range of changes as in registers 5016 ... 5045	
<b>Master 10</b>		
7796...7805	Range of changes as in registers 5006 ... 5015	
<b>Master 10 – register 1</b>		
7806...7835	Range of changes as in registers 5016 ... 5045	
<b>Master 10 – register 2</b>		
7836...7865	Range of changes as in registers 5016 ... 5045	
<b>Master 10 – register 3</b>		
7866...7895	Range of changes as in registers 5016 ... 5045	
<b>Master 10 – register 4</b>		
7896...7925	Range of changes as in registers 5016 ... 5045	
<b>Master 10 – register 5</b>		
7926...7955	Range of changes as in registers 5016 ... 5045	
<b>Master 10 – register 6</b>		
7956...7985	Range of changes as in registers 5016 ... 5045	
<b>Master 10 – register 7</b>		
7986...8015	Range of changes as in registers 5016 ... 5045	
<b>Master 10 – register 8</b>		
8016...8045	Range of changes as in registers 5016 ... 5045	
<b>Master 10 – register 9</b>		
8046...8075	Range of modifications as in registers 5016...5045	
<b>Master 10 – register 10</b>		
8076...8105	Range of changes as in registers 5016 ... 5045	

Default values for: "Register x - name"

Master 1 - Registers 1 ... 10 name - "MM1-Reg1" ... "MM1-Reg10"  
 Master 2 - Registers 1 ... 10 name - "MM2-Reg1" ... "MM2-Reg10"  
 Master 3 - Registers 1 ... 10 name - "MM3-Reg1" ... "MM3-Reg10"  
 Master 4 - Registers 1 ... 10 name - "MM4-Reg1" ... "MM4-Reg10"  
 Master 5 - Registers 1 ... 10 name - "MM5-Reg1" ... "MM5-Reg10"  
 Master 6 - Registers 1 ... 10 name - "MM6-Reg1" ... "MM6-Reg10"  
 Master 7 - Registers 1 ... 10 name - "MM7-Reg1" ... "MM7-Reg10"  
 Master 8 - Registers 1 ... 10 Name - "MM8-Reg1" ... "MM8-Reg10"  
 Master 9 - Registers 1 ... 10 Name - "MM9-Reg1" ... "MM9-Reg10"  
 Master 10 - Registers 1 ... 10 name - "MM10-Reg1" ... "MM10-Reg10"

# User's manual

## Group configuration registers

Table 19.

Register address	Operations	Range	Description	By default
8110	RW	0x0000...0x03FF	N group on / off bit 0 - 0- group 1 disabled, 1- group 1 enabled bit 1 - 0- group 2 disabled, 1- group 1 enabled .. bit 9 - 0- group 10 disabled, 1- group 10 enabled	0x03FF
<b>Group 1</b>				
8111	RW	0x0000...0x003F	Number of displayed fields bit 0 - 0- field 1 disabled, 1- field 1 enabled bit 1 - 0- field 2 disabled, 1- field 1 enabled .. bit 5 - 0- field 6 disabled, 1- field 6 enabled	0x003F
8112	RW	0...2	Bar chart type 0 - disabled 1 - horizontal 2 - vertical	1
8113	RW	0...2	Line charts type 0 - disabled 1 - horizontal 2 - vertical	1
8114	RW	0...13	Time base 0 - 30 seconds, 1 - 1 minute, 2 - 2 minutes, 3 - 5 minutes, 4 - 10 minutes, 5 - 15 minutes, 6 - 30 minutes, 7 - 1 hour, 8 - 2 hours, 9 - 4 hours, 10 - 12 hours, 11 - 24 hours, 12 - 2 days, 13 - 7 days	2
8115	RW	0...1	Colour of background 0 – black, 1 – white	0
<b>Group 1– field 1</b>				
8116	RW	0...59	Value source 0...59 – virtual channel no	1
8117	RW	1...6	Number of sectors	1
8118	RW	0...12	Colour of sector 1 0 - green, 1 - red, 2 - yellow, 3 - white, 4 - blue, 5 - purple, 6 - light blue, 7 - olive, 8 - black, 9 - light green, 10 - orange, 11 - dark red, 12 - grey	0
8119	RW	-2147400000	High-end colour value for sector 1 Lo x10	0
8120	RW	2147400000	High-end colour value for sector 1 Hi x10	
8121	RW	0...12	Colour of sector 2 0 - green, 1 - red, 2 - yellow, 3 - white, 4 - blue, 5 -purple, 6 - light blue, 7 - olive, 8 - black, 9 - light green, 10 - orange, 11 - dark red, 12 - grey	1
8122	RW	-2147400000	High-end colour value for sector 2 Lo x10	1000
8123	RW	2147400000	High-end colour value for sector 2 Hi x10	
8124	RW	0...12	Colour of sector 3 0 - green, 1 - red, 2 - yellow, 3 - white, 4 - blue, 5 -purple, 6 - light blue, 7 - olive, 8 - black, 9 - light green, 10 - orange, 11 - dark red, 12 - grey	2
8125	RW	-2147400000	High-end colour value for sector 3 Lo x10	2000
8126	RW	2147400000	High-end colour value for sector 3 Hi x10	
8127	RW	0...12	Colour of sector 4 0 - green, 1 - red, 2 - yellow, 3 - white, 4 - blue, 5 -purple, 6 - light blue, 7 - olive, 8 - black, 9 - light green, 10 - orange, 11 - dark red, 12 - grey	3
8128	RW	-2147400000	High-end colour value for sector 4 Lo x10	



## User's manual

8129	RW	2147400000	High-end colour value for sector 4 Hi x10	3000
------	----	------------	---	------

8130	RW	0...12	Colour of sector 5 0 - green, 1 - red, 2 - yellow, 3 - white, 4 - blue, 5 -purple, 6 - light blue, 7 - olive, 8 - black, 9 - light green, 10 - orange, 11 - dark red, 12 - grey	4
8131	RW	-2147400000	High-end colour value for sector 5 Lo x10	4000
8132	RW	2147400000	High-end colour value for sector 5 Hi x10	
8133	RW	0...12	Colour of sector 6 0 - green, 1 - red, 2 - yellow, 3 - white, 4 - blue, 5 -purple, 6 - light blue, 7 - olive, 8 - black, 9 - light green, 10 - orange, 11 - dark red, 12 - grey	5
8134	RW	0...4	Decimal point 0 - automatic, 1 - 0, 2 - 0.0, 3 - 0.00, 4 - 0.000 Binary values are always displayed without a decimal point as 0 or 1 values	0
8135	RW	0...1	Display of binary values 0 - as a numerical value (0 or 1) 1 - as a string (Following subtitles from registers are displayed: Label OFF, Label ON or in the case of mathematical functions 18 ... 20, 33 ... 43 the inscriptions TRUE, FALSE are displayed)	0
<b>Group 1 - field 2</b>				
8136...8155		Range of modifications as in registers 8116...8135		
<b>Group 1 - field 3</b>				
8156...8175		Range of modifications as in registers 8116...8135		
<b>Group 1 - field 4</b>				
8176...8195		Range of modifications as in registers 8116...8135		
<b>Group 1 - field 5</b>				
8196...8215		Range of modifications as in registers 8116...8135		
<b>Group 1 - field 6</b>				
8216...8235		Range of modifications as in registers 8116...8135		
<b>Group 2</b>				
8236...8240		Range of modifications as in registers 8111...8115		
<b>Group 2 - field 1</b>				
8241...8260		Range of modifications as in registers 8116...8135		
<b>Group 2 - field 2</b>				
8261...8280		Range of modifications as in registers 8116...8135		
<b>Group 2 - field 3</b>				
8281...8300		Range of modifications as in registers 8116...8135		
<b>Group 2 - field 4</b>				
8301...8320		Range of modifications as in registers 8116...8135		
<b>Group 2 - field 5</b>				
8321...8340		Range of modifications as in registers 8116...8135		
<b>Group 2 - field 6</b>				
8341...8360		Range of modifications as in registers 8116...8135		
<b>Group 3</b>				
8361...8365		Range of modifications as in registers 8111...8115		
<b>Group 3 - field 1</b>				
8366...8385		Range of modifications as in registers 8116...8135		
<b>Group 3 - field 2</b>				
8386...8405		Range of modifications as in registers 8116...8135		
<b>Group 3 - field 3</b>				
8406...8425		Range of modifications as in registers 8116...8135		
<b>Group 3 - field 4</b>				
8426...8445		Range of modifications as in registers 8116...8135		
<b>Group 3 - field 5</b>				
8446...8465		Range of modifications as in registers 8116...8135		
<b>Group 3 - field 6</b>				
8466...8485		Range of modifications as in registers 8116...8135		
<b>Group 4</b>				

## User's manual

8486...8490	Range of modifications as in registers 8111...8115	
-------------	--	--

<b>Group 4 - field 1</b>		
8491...8510	Range of modifications as in registers 8116...8135	
<b>Group 4 - field 2</b>		
8511...8530	Range of modifications as in registers 8116...8135	
<b>Group 4 - field 3</b>		
8531...8550	Range of modifications as in registers 8116...8135	
<b>Group 4 - field 4</b>		
8551...8570	Range of modifications as in registers 8116...8135	
<b>Group 4 - field 5</b>		
8571...8590	Range of modifications as in registers 8116...8135	
<b>Group 4 - field 6</b>		
8591...8610	Range of modifications as in registers 8116...8135	
<b>Group 5</b>		
8611...8615	Range of modifications as in registers 8111...8115	
<b>Group 5 - field 1</b>		
8616...8635	Range of modifications as in registers 8116...8135	
<b>Group 5 - field 2</b>		
8636...8655	Range of modifications as in registers 8116...8135	
<b>Group 5 - field 3</b>		
8656...8675	Range of modifications as in registers 8116...8135	
<b>Group 5 - field 4</b>		
8676...8695	Range of modifications as in registers 8116...8135	
<b>Group 5 - field 5</b>		
8696...8715	Range of modifications as in registers 8116...8135	
<b>Group 5 - field 6</b>		
8716...8735	Range of modifications as in registers 8116...8135	
<b>Group 6</b>		
8736...8740	Range of modifications as in registers 8111...8115	
<b>Group 6 - field 1</b>		
8741...8760	Range of modifications as in registers 8116...8135	
<b>Group 6 - field 2</b>		
8761...8780	Range of modifications as in registers 8116...8135	
<b>Group 6 - field 3</b>		
8781...8800	Range of modifications as in registers 8116...8135	
<b>Group 6 - field 4</b>		
8801...8820	Range of modifications as in registers 8116...8135	
<b>Group 6 - field 5</b>		
8821...8840	Range of modifications as in registers 8116...8135	
<b>Group 6 - field 6</b>		
8841...8860	Range of modifications as in registers 8116...8135	
<b>Group 7</b>		
8861...8865	Range of modifications as in registers 8111...8115	
<b>Group 7 - field 1</b>		
8866...8885	Range of modifications as in registers 8116...8135	
<b>Group 7 - field 2</b>		
8886...8905	Range of modifications as in registers 8116...8135	
<b>Group 7 - field 3</b>		
8906...8925	Range of modifications as in registers 8116...8135	
<b>Group 7 - field 4</b>		
8926...8945	Range of modifications as in registers 8116...8135	
<b>Group 7 - field 5</b>		
8946...8965	Range of modifications as in registers 8116...8135	
<b>Group 7 - field 6</b>		
8966...8985	Range of modifications as in registers 8116...8135	
<b>Group 8</b>		
8986...8990	Range of modifications as in registers 8111...8115	
<b>Group 8 - field 1</b>		
8991...9010	Range of modifications as in registers 8116...8135	
<b>Group 8 - field 2</b>		

## User's manual

9011...9030	Range of modifications as in registers 8116...8135	
-------------	--	--

<b>Group 8 - field 3</b>		
9031...9050	Range of modifications as in registers 8116...8135	
<b>Group 8 - field 4</b>		
9051...9070	Range of modifications as in registers 8116...8135	
<b>Group 8 - field 5</b>		
9071...9090	Range of modifications as in registers 8116...8135	
<b>Group 8 - field 6</b>		
9091...9110	Range of modifications as in registers 8116...8135	
<b>Group 9</b>		
9111...9115	Range of modifications as in registers 8111...8115	
<b>Group 9 - field 1</b>		
9116...9135	Range of modifications as in registers 8116...8135	
<b>Group 9 - field 2</b>		
9126...9155	Range of modifications as in registers 8116...8135	
<b>Group 9 - field 3</b>		
9156...9175	Range of modifications as in registers 8116...8135	
<b>Group 9 - field 4</b>		
9176...9195	Range of modifications as in registers 8116...8135	
<b>Group 9 - field 5</b>		
9196...9215	Range of modifications as in registers 8116...8135	
<b>Group 9 - field 6</b>		
9216...9235	Range of modifications as in registers 8116...8135	
<b>Group 10</b>		
9236...9240	Range of modifications as in registers 8111...8115	
<b>Group 10 - field 1</b>		
9241...9260	Range of modifications as in registers 8116...8135	
<b>Group 10 - field 2</b>		
9261...9280	Range of modifications as in registers 8116...8135	
<b>Group 10 - field 3</b>		
9281...9300	Range of modifications as in registers 8116...8135	
<b>Group 10 - field 4</b>		
9301...9320	Range of modifications as in registers 8116...8135	
<b>Group 10 - field 5</b>		
9321...9340	Range of modifications as in registers 8116...8135	
<b>Group 10 - field 6</b>		
9341...9360	Range of modifications as in registers 8116...8135	

### Inputs and Outputs configuration registers

Table 20

Register address	Operations	Range	Description	By default
			<b>Slot (Z) Out 1 (relay)</b>	
9370	RW	0...59	Value source (channel no.)	0
9371	RW	0...1	Relay operation state 0 - normal (contacts closed in the active state) 1 - negated (contacts open in the active state)	0
9372	RW	0, 0x2020..0x7A7A	OFF tag ASCII 2 and 1 characters	0x4F46
9373	RW	0, 0x2020..0x7A7A	OFF tag ASCII 4 and 3 characters	0x4620
9374	RW	0, 0x2020..0x7A7A	OFF tag ASCII 6 and 5 characters	0x2020
9375	RW	0, 0x2020..0x7A7A	OFF tag ASCII 8 and 7 characters	0x2020
9376	RW	0, 0x2020..0x7A7A	ON tag ASCII 2 and 1 characters	0x4F4E
9377	RW	0, 0x2020..0x7A7A	ON tag ASCII 4 and 3 characters	0x2020
9378	RW	0, 0x2020..0x7A7A	ON tag ASCII 6 and 5 characters	0x2020
9379	RW	0, 0x2020..0x7A7A	ON tag ASCII 8 and 7 characters	0x2020

## User's manual

9380			reserved	
9381			reserved	
9382			reserved	

Register address	Operations	Range	Description	Default
9383			reserved	
9384			reserved	
9385			reserved	
9386			reserved	
9387			reserved	
9388			reserved	
9389			reserved	
9390	RW	0, 0x2020..0x7A7A	name ASCII 2 and 1 characters	0x2020
9391	RW	0, 0x2020..0x7A7A	name ASCII 4 and 3 characters	0x2020
9392	RW	0, 0x2020..0x7A7A	name ASCII 6 and 5 characters	0x2020
9393	RW	0, 0x2020..0x7A7A	name ASCII 8 and 7 characters	0x2020
9394	RW	0, 0x2020..0x7A7A	name ASCII 10 and 9 characters	0x2020
9395	RW	0, 0x2020..0x7A7A	name ASCII 12 and 11 characters	0x2020
9396	R	0, 0x2020..0x7A7A	Unit ASCII 2 and 1 characters	0x2020
9397	R	0, 0x2020..0x7A7A	Unit ASCII 4 and 3 characters	0x2020
9398	R	0, 0x2020..0x7A7A	Unit ASCII 6 and 5 characters	0x2020
9399	R	0, 0x2020..0x7A7A	Unit ASCII 8 and 7 characters	0x2020
			<b>Slot (Z) Out 2 (relay)</b>	
9400..9429			As registers 9370. 9399	
			<b>Slot (Z) In 1 (binary input)</b>	
9430	RW	0, 0x2020..0x7A7A	OFF tag ASCII 2 and 1 characters	0x4F46
9431	RW	0, 0x2020..0x7A7A	OFF tag ASCII 4 and 3 characters	0x4620
9432	RW	0, 0x2020..0x7A7A	OFF tag ASCII 6 and 5 characters	0x2020
9433	RW	0, 0x2020..0x7A7A	OFF tag ASCII 8 and 7 characters	0x2020
9434	RW	0, 0x2020..0x7A7A	ON tag ASCII 2 and 1 characters	0x4F4E
9435	RW	0, 0x2020..0x7A7A	ON tag ASCII 4 and 3 characters	0x2020
9436	RW	0, 0x2020..0x7A7A	ON tag ASCII 6 and 5 characters	0x2020
9437	RW	0, 0x2020..0x7A7A	ON tag ASCII 8 and 7 characters	0x2020
9438	RW	0.1	Active state for the input 0 - normal 1 - negated	0
9439			reserved	
9440			reserved	
9441			reserved	
9442			reserved	
9443			reserved	
9444			reserved	
9445	RW	0, 0x2020..0x7A7A	name ASCII 2 and 1 characters	0x2020
9446	RW	0, 0x2020..0x7A7A	name ASCII 4 and 3 characters	0x2020
9447	RW	0, 0x2020..0x7A7A	name ASCII 6 and 5 characters	0x2020
9448	RW	0, 0x2020..0x7A7A	name ASCII 8 and 7 characters	0x2020
9449	RW	0, 0x2020..0x7A7A	name ASCII 10 and 9 characters	0x2020
9450	RW	0, 0x2020..0x7A7A	name ASCII 12 and 11 characters	0x2020
9451	R	0, 0x2020..0x7A7A	Unit ASCII 2 and 1 characters	0x2020
9452	R	0, 0x2020..0x7A7A	Unit ASCII 4 and 3 characters	0x2020
9453	R	0, 0x2020..0x7A7A	Unit ASCII 6 and 5 characters	0x2020
9454	R	0, 0x2020..0x7A7A	Unit ASCII 8 and 7 characters	0x2020
			<b>Slot (Z) In 2 (binary input)</b>	
9455..9479			As registers 9430. 9454	
<b>6 x relay outputs module</b>				
			<b>Slot (X) Out 1 (relay)</b>	
9480..9509			As registers 9370. 9399	
			<b>Slot (X) Out 2 (relay)</b>	
9510..9539			As registers 9370. 9399	

## User's manual

			<b>Slot (X) Out 3 (relay)</b>	
9540..9569			As registers 9370. 9399	

Register address	Operations	Range	Description	By default
			<b>Slot (X) Out 4 (relay)</b>	
9570..9599			As registers 9370. 9399	
			<b>Slot (X) Out 5 (relay)</b>	
9600..9629			As registers 9370. 9399	
			<b>Slot (X) Out 6 (relay)</b>	
9630..9659			As registers 9370. 9399	
			<b>Slot (Y) Out 1 (relay)</b>	
9660..9689			As registers 9370. 9399	
			<b>Slot (Y) Out 2 (relay)</b>	
9690..9719			As registers 9370. 9399	
			<b>Slot (Y) Out 3 (relay)</b>	
9720..9749			As registers 9370. 9399	
			<b>Slot (Y) Out 4 (relay)</b>	
9750..9779			As registers 9370. 9399	
			<b>Slot (Y) Out 5 (relay)</b>	
9780..9809			As registers 9370. 9399	
			<b>Slot (Y) Out 6 (relay)</b>	
9810..9839			As registers 9370. 9399	
<b>4 x relay outputs module + 4 x binary inputs separated from each others</b>				
			<b>Slot (X) Out 1 (relay)</b>	
9840..9869			As registers 9370. 9399	
			<b>Slot (X) Out 2 (relay)</b>	
9870..9899			As registers 9370. 9399	
			<b>Slot (X) Out 3 (relay)</b>	
9900..9929			As registers 9370. 9399	
			<b>Slot (X) Out 4 (relay)</b>	
9930..9959			As registers 9370. 9399	
			<b>Slot (X) In 1 (binary input)</b>	
9960..9984			As registers 9430. 9454	
			<b>Slot (X) In 2 (binary input)</b>	
9985..10009			As registers 9430. 9454	
			<b>Slot (X) In 3 (binary input)</b>	
10010..10034			As registers 9430. 9454	
			<b>Slot (X) In 4 (binary input)</b>	
10035..10059			As registers 9430. 9454	
			<b>Slot (Y) Out 1</b>	
10060..10089			As registers 9370. 9399	
			<b>Slot (Y) Out 2</b>	
10090..10119			As registers 9370. 9399	
			<b>Slot (Y) Out 3</b>	
10120..10149			As registers 9370. 9399	
			<b>Slot (Y) Out 4</b>	
10150..10179			As registers 9370. 9399	
			<b>Slot (Y) In 1 (binary input)</b>	
10180..10204			As registers 9430. 9454	
			<b>Slot (Y) In 2 (binary input)</b>	
10205..10229			As registers 9430. 9454	
			<b>Slot (Y) In 3 (binary input)</b>	
10230..10254			As registers 9430. 9454	
			<b>Slot (Y) In 4 (binary input)</b>	
10255..10279			As registers 9430. 9454	
<b>4 x analogue output module + 4 x binary inputs with common ground</b>				
			<b>Slot (X) Out 1 (Analogue output)</b>	
10280	RW	0...59	Value source (channel no.)	0
10281	RW	0/400...2000	The output state in case of an event (error, exceeding the range Lo or Hi) x100	0

## User's manual

10282	RW	-2147400000	Lo input lower threshold (Lo inp) x100	-9999999
10283	RW	..	Hi input lower threshold (Lo inp) x100	

Register address	Operations	Range	Description	By default
10284	RW	2147400000 -2147400000	Lo input upper threshold (Hi inp) x100	9999999
10285	RW	.. 2147400000	Hi input upper threshold (Hi inp) x100	
10286	RW	0..2000	Lo output lower threshold (Lo inp) x100	400
10287	RW		Hi output lower threshold (Lo inp) x100	
10288	RW	0/400. 2000	Lo output upper threshold (Hi inp) x100	2000
10289	RW		Hi output upper threshold (Hi inp) x100	
10290	RW	0.1	Analogue output operating mode 0 - 0 ... 20mA, 1 - 4 ... 20 mA	0
10291			reserved	
10292			reserved	
10293			reserved	
10294			reserved	
10295	RW	0, 0x2020..0x7A7A	name ASCII 2 and 1 characters	0x2020
10296	RW	0, 0x2020..0x7A7A	name ASCII 4 and 3 characters	0x2020
10297	RW	0, 0x2020..0x7A7A	name ASCII 6 and 5 characters	0x2020
10298	RW	0, 0x2020..0x7A7A	name ASCII 8 and 7 characters	0x2020
10299	RW	0, 0x2020..0x7A7A	name ASCII 10 and 9 characters	0x2020
10300	RW	0, 0x2020..0x7A7A	name ASCII 12 and 11 characters	0x2020
10301	R	0, 0x2020..0x7A7A	Unit ASCII 2 and 1 characters	0x2020
10302	R	0, 0x2020..0x7A7A	Unit ASCII 4 and 3 characters	0x2020
10303	R	0, 0x2020..0x7A7A	Unit ASCII 6 and 5 characters	0x2020
10304	R	0, 0x2020..0x7A7A	Unit ASCII 8 and 7 characters	0x2020
			<b>Slot (X) Out 2 (Analogue output)</b>	
10305..10329			As registers 10280. 10304	
			<b>Slot (X) Out 3 (Analogue output)</b>	
10330..10354			As registers 10280. 10304	
			<b>Slot (X) Out 4 (Analogue output)</b>	
10355..10379			As registers 10280. 10304	
			<b>Slot (X) In 1 (binary input)</b>	
10380..10404			As registers 9430. 9454	
			<b>Slot (X) In 2 (binary input)</b>	
10405..10429			As registers 9430. 9454	
			<b>Slot (X) In 3 (binary input)</b>	
10430..10454			As registers 9430. 9454	
			<b>Slot (X) In 4 (binary input)</b>	
10455..10479			As registers 9430. 9454	
			<b>Slot (Y) Out 1 (Analogue output)</b>	
10480..10504			As registers 10280. 10304	
			<b>Slot (Y) Out 2 (Analogue output)</b>	
10505..10529			As registers 10280. 10304	
			<b>Slot (Y) Out 3 (Analogue output)</b>	
10530..10554			As registers 10280. 10304	
			<b>Slot (Y) Out 4 (Analogue output)</b>	
10555..10579			As registers 10280. 10304	
			<b>Slot (Y) In 1 (binary input)</b>	
10580..10604			As registers 9430. 9454	
			<b>Slot (Y) In 2 (binary input)</b>	
10605..10629			As registers 9430. 9454	
			<b>Slot (Y) In 3 (binary input)</b>	
10630..10654			As registers 9430. 9454	
			<b>Slot (Y) In 4 (binary input)</b>	
10655..10679			As registers 9430. 9454	
<b>4 x programmable measuring inputs module</b>				
			<b>Slot (X) In 1 (universal input)</b>	

## User's manual

10680	RW	0..19	Input type 0 - +-10V, 1 - 0..10V, 2 - +-300mV, 3 - 0..300mV,	0
-------	----	-------	--	---

## User's manual

Register address	Operations	Range	Description	By default
			4 - +-75mV, 5 – 0..75mV, 6 - +-40mA, 7 – 0..40mA, 8 – Pt100, 9 – Pt500, 10 – Pt1000, 11 – 0..4000 Ohm, 12 – TC J, 13 – TC K, 14 – TC N, 15 – TC E, 16 – TC T, 17 – TC S, 18 – TC R, 19 – TC B	
10681	RW	0..1	Sensor connecting type 0 - 3 wire, 1 - 2 wire or Type of compensation 0 - automatic, 1 - manual	1
10682	RW	0..6000	Wire resistance x100 or Compensation value x100	0
10683	RW	-200...200	Temperature offset x10	0
10684	RW	50...600	Averaging time x10	5
10685	RW	0..1	Unit for TC and Pt sensors 0 – C° degree, 1 – F° degree	0
10686	RW	-9999999..9999999	Min Lo x10	-120
10687	RW		Min. Hi x10	
10688	RW		Max Lo x10	120
10689	RW		Max Hi x10	
10690			reserved	
10691			reserved	
10692			reserved	
10693			reserved	
10694			reserved	
10695	RW		name ASCII 2 and 1 characters	
10696	RW		name ASCII 4 and 3 characters	
10697	RW		name ASCII 6 and 5 characters	
10698	RW		name ASCII 8 and 7 characters	
10699	RW		name ASCII 10 and 9 characters	
10700	RW		name ASCII 12 and 11 characters	
10701	R		Unit ASCII 2 and 1 characters	
10702	R		Unit ASCII 4 and 3 characters	
10703	R		Unit ASCII 6 and 5 characters	
10704	R		Unit ASCII 8 and 7 characters	
			<b>Slot (X) In 2 (universal input)</b>	
10705..10729			As registers 10680. 10704	
			<b>Slot (X) In 3 (universal input)</b>	
10730..10754			As registers 10680. 10704	
			<b>Slot (X) In 4 (universal input)</b>	
10755..10779			As registers 10680. 10704	
			<b>Slot (Y) In 1 (universal input)</b>	
10780..10804			As registers 10680. 10704	
			<b>Slot (Y) In 2 (universal input)</b>	
10805..10829			As registers 10680. 10704	
			<b>Slot (Y) In 3 (universal input)</b>	
10830..10854			As registers 10680. 10704	
			<b>Slot (Y) In 4 (universal input)</b>	
10855..10879			As registers 10680. 10704	



Logical channels configuration registers

Table 21

Register address	Operations	Range	Description	By default
10900	RW	0x0000...0xFFFF	Enabling / disabling logic channels 1 ... 16 bit 0 - 0 - channel 1 disabled, 1 - channel 1 enabled bit 1 - 0 - channel 2 disabled, 1 - channel 2 enabled ... bit 15 - 0 - channel 16 disabled, 1 - channel 16 enabled	0xFFFF
10901	RW	0x0000...0xFFFF	Enabling / disabling logic channels 17 ... 32 bit 16 - 0 - channel 17 disabled, 1 - channel 17 enabled bit 17 - 0 - channel 18 disabled, 1 - channel 18 enabled ... bit 31 - 0 - channel 32 disabled, 1 - channel 32 enabled	0x0000
10902	RW	0x0000...0xFFFF	Enabling / disabling logic channels 33 ... 48 bit 32 - 0 - channel 33 disabled, 1 - channel 33 enabled bit 33 - 0 - channel 34 disabled, 1 - channel 34 enabled ... bit 47 - 0 - channel 48 disabled, 1 - channel 48 enabled	0x0000
10903	RW	0x0000...0x0FFF	Enabling / disabling logic channels 49 ... 60 bit 48 - 0 - channel 49 disabled, 1 - channel 49 enabled bit 49 - 0 - channel 50 disabled, 1 - channel 50 enabled ... bit 59 - 0 - channel 60 disabled, 1 - channel 60 enabled	0x0000
<b>Logical channel 1</b>				
			Source type	
10904	RW	0...6	0 - Inputs 1 - Outputs 2 - Modbus Master 3 - Mathematical function 4 - From another channel 5 - Scaling function 6 - Alarm function	0
10905	RW	0...2/9/19/59	Source selection range of changes: for Source type = 0 and 1 - the range of changes depends on the recorder hardware configuration (0 ... 2-12) for Source type = 2 - range of changes (0 ... 9) for Source type = 3 - range of changes (0 ... 27) for Source type = 4 - range of changes (0 ... 59) for Source type = 5 and 6 - range of changes (0 ... 19)	0
10906	RW	0...9	Register selection when Source Type: 2 - Modbus master 0 - Register 1, ..., 9 - Register 10	0
10907			reserved	
10908			reserved	
<b>Logical channel 2</b>				
10909...10913			Range of modifications as in registers 10904...10908	
<b>Logical channel 3</b>				
10914...10918			Range of modifications as in registers 10904...10908	
<b>Logical channel 4</b>				
10919...10923			Range of modifications as in registers 10904...10908	
<b>Logical channel 5</b>				
10924...10928			Range of modifications as in registers 10904...10908	
<b>Logical channel 6</b>				
10929...10933			Range of modifications as in registers 10904...10908	
<b>Logical channel 7</b>				
10934...10938			Range of modifications as in registers 10904...10908	
<b>Logical channel 8</b>				
10939...10943			Range of modifications as in registers 10904...10908	
<b>Logical channel 9</b>				
10944...10948			Range of modifications as in registers 10904...10908	
<b>Logical channel 10</b>				
10949...10953			Range of modifications as in registers 10904...10908	

## User's manual

<b>Logical channel 11</b>		
10954...10958	Range of modifications as in registers 10904...10908	
<b>Logical channel 12</b>		
10959...10963	Range of modifications as in registers 10904...10908	
<b>Logical channel 13</b>		
10964...10968	Range of modifications as in registers 10904...10908	
<b>Logical channel 14</b>		
10969...10973	Range of modifications as in registers 10904...10908	
<b>Logical channel 15</b>		
10974...10978	Range of modifications as in registers 10904...10908	
<b>Logical channel 16</b>		
10979...10983	Range of modifications as in registers 10904...10908	
<b>Logical channel 17</b>		
10984...10988	Range of modifications as in registers 10904...10908	
<b>Logical channel 18</b>		
10989...10993	Range of modifications as in registers 10904...10908	
<b>Logical channel 19</b>		
10994...10998	Range of modifications as in registers 10904...10908	
<b>Logical channel 20</b>		
10999...11003	Range of modifications as in registers 10904...10908	
<b>Logical channel 21</b>		
11004...11008	Range of modifications as in registers 10904...10908	
<b>Logical channel 22</b>		
11009...11013	Range of modifications as in registers 10904...10908	
<b>Logical channel 23</b>		
11014...11018	Range of modifications as in registers 10904...10908	
<b>Logical channel 24</b>		
11019...11023	Range of modifications as in registers 10904...10908	
<b>Logical channel 25</b>		
11024...11028	Range of modifications as in registers 10904...10908	
<b>Logical channel 26</b>		
11029...11033	Range of modifications as in registers 10904...10908	
<b>Logical channel 27</b>		
11034...11038	Range of modifications as in registers 10904...10908	
<b>Logical channel 28</b>		
11039...11043	Range of modifications as in registers 10904...10908	
<b>Logical channel 29</b>		
11044...11048	Range of modifications as in registers 10904...10908	
<b>Logical channel 30</b>		
11049...11053	Range of modifications as in registers 10904...10908	
<b>Logical channel 31</b>		
11054...11058	Range of modifications as in registers 10904...10908	
<b>Logical channel 32</b>		
11059...11063	Range of modifications as in registers 10904...10908	
<b>Logical channel 33</b>		
11064...11068	Range of modifications as in registers 10904...10908	
<b>Logical channel 34</b>		
11069...11073	Range of modifications as in registers 10904...10908	
<b>Logical channel 35</b>		
11074...11078	Range of modifications as in registers 10904...10908	
<b>Logical channel 36</b>		
11079...11083	Range of modifications as in registers 10904...10908	
<b>Logical channel 37</b>		
11084...11088	Range of modifications as in registers 10904...10908	
<b>Logical channel 38</b>		
11089...11093	Range of modifications as in registers 10904...10908	
<b>Logical channel 39</b>		
11094...11098	Range of modifications as in registers 10904...10908	
<b>Logical channel 40</b>		
11099...11103	Range of modifications as in registers 10904...10908	

<b>Logical channel 41</b>		
11104...11108	Range of modifications as in registers 10904...10908	
<b>Logical channel 42</b>		
11109...11113	Range of modifications as in registers 10904...10908	
<b>Logical channel 43</b>		
11114...11118	Range of modifications as in registers 10904...10908	
<b>Logical channel 44</b>		
11119...11123	Range of modifications as in registers 10904...10908	
<b>Logical channel 45</b>		
11124...11128	Range of modifications as in registers 10904...10908	
<b>Logical channel 46</b>		
11129...11133	Range of modifications as in registers 10904...10908	
<b>Logical channel 47</b>		
11134...11138	Range of modifications as in registers 10904...10908	
<b>Logical channel 48</b>		
11139...11143	Range of modifications as in registers 10904...10908	
<b>Logical channel 49</b>		
11144...11148	Range of modifications as in registers 10904...10908	
<b>Logical channel 50</b>		
11149...11153	Range of modifications as in registers 10904...10908	
<b>Logical channel 51</b>		
11154...11158	Range of modifications as in registers 10904...10908	
<b>Logical channel 52</b>		
11159...11163	Range of modifications as in registers 10904...10908	
<b>Logical channel 53</b>		
11164...11168	Range of modifications as in registers 10904...10908	
<b>Logical channel 54</b>		
11169...11173	Range of modifications as in registers 10904...10908	
<b>Logical channel 55</b>		
11174...11178	Range of modifications as in registers 10904...10908	
<b>Logical channel 56</b>		
11179...11183	Range of modifications as in registers 10904...10908	
<b>Logical channel 57</b>		
11184...11188	Range of modifications as in registers 10904...10908	
<b>Logical channel 58</b>		
11189...11193	Range of modifications as in registers 10904...10908	
<b>Logical channel 59</b>		
11194...11198	Range of modifications as in registers 10904...10908	
<b>Logical channel 60</b>		
11199...11203	Range of modifications as in registers 10904...10908	

Table. Configuration registers of “Mt” mathematical functions Table 22

Register address	Operations	Range	Description	Sufficient param. in the maths function.			By default
				1..6	7..11	12..28	
<b>Mt 1</b>				●	●	●	
11300	RW	0...28	Type of mathematical function 0 - function disabled 1 ... 28 - function number (see the list of functions)	●	●	●	0
11301	RW	0...1	Source type 0– From a logical channel X 1– Constant value of X	●	☒	●	0
11302	RW	0...59	No of the logical channel X	●	☒	●	0
11303	RW	-	Numerical value X Lo x10	●	☒	●	0
11304	RW	2147400000 .. 2147400000	Numerical value X Hi x10	●	☒	●	0

## User's manual

11305	RW	0...0xFFFF	List of logical channel 1. 16 bit 0 - 0 - logic channel 1 not selected, 1- channel logical 1 selected. bit 1 - 0 - logic channel 2 not selected, 1- channel	<input checked="" type="checkbox"/>	<input checked="" type="checkbox"/>	<input checked="" type="checkbox"/>	0
			logical 2 selected. ... bit 15 - 0 - logic channel 16 not selected, 1- logic channel 16 selected				
11306	RW	0...0xFFFF	List of logical channel 17. 32 bit 16 - 0 - logic channel 17 not selected, 1- logic channel 17 selected bit 17 - 0 - logic channel 18 not selected, 1- logic channel 18 selected ... bit 31 - 0 - logic channel 32 not selected, 1- logic channel 32 selected	<input checked="" type="checkbox"/>	<input checked="" type="checkbox"/>	<input checked="" type="checkbox"/>	0
11307	RW	0...0xFFFF	List of logical channel 33. 48 bit 32 - 0 - logic channel 33 not selected, 1- logic channel 33 selected bit 33 - 0 - logic channel 34 not selected, 1- logic channel 34 selected ... bit 47 - 0 - logic channel 48 not selected, 1- logic channel 48 selected	<input checked="" type="checkbox"/>	<input checked="" type="checkbox"/>	<input checked="" type="checkbox"/>	0
11308	RW	0...0x0FFF	List of logical channel 49. 60 bit 48 - 0 - logic channel 49 not selected, 1- logic channel 49 selected bit 49 - 0 - logic channel 50 not selected, 1- logic channel 50 selected ... bit 59 - 0 - logic channel 60 not selected, 1- logic channel 60 selected	<input checked="" type="checkbox"/>	<input checked="" type="checkbox"/>	<input checked="" type="checkbox"/>	0
11309	RW	0...1	In the event of an error: 0 – include channel with error in calculations 1 - omit channel in calculations	<input checked="" type="checkbox"/>	<input checked="" type="checkbox"/>	<input checked="" type="checkbox"/>	1
11310	RW	0...1	Source type 0– From a logical channel Y 1– Constant value of Y	<input checked="" type="checkbox"/>	<input checked="" type="checkbox"/>	<input checked="" type="checkbox"/>	0
11311	RW	0...59	No of the logical channel Y	<input checked="" type="checkbox"/>	<input checked="" type="checkbox"/>	<input checked="" type="checkbox"/>	0
11312	RW	-	Numerical value Y Lo x10				
11313	RW	2147400000 .. 2147400000	Numerical value Y Hi x10	<input checked="" type="checkbox"/>	<input checked="" type="checkbox"/>	<input checked="" type="checkbox"/>	0
11314	RW	-	Min. value to display Lo x10				-
11315	RW	2147400000 .. 2147400000	Min. value to display Hi x10	<input checked="" type="checkbox"/>	<input checked="" type="checkbox"/>	<input checked="" type="checkbox"/>	999999 9
11316	RW	-	Max. value to display Lo x10				
11317	RW	2147400000 .. 2147400000	Max. value to display Hi x10	<input checked="" type="checkbox"/>	<input checked="" type="checkbox"/>	<input checked="" type="checkbox"/>	999999 9
11318			reserved				
11319			reserved				
<b>Mt 2</b>							
11320...11339		Range of changes as in registers 11300 ... 11319					
<b>Mt 3</b>							
11340...11359		Range of changes as in registers 11300 ... 11319					
<b>Mt 4</b>							
11360...11379		Range of changes as in registers 11300 ... 11319					
<b>Mt 5</b>							
11380...11399		Range of changes as in registers 11300 ... 11319					
<b>Mt 6</b>							
11400...11419		Range of changes as in registers 11300 ... 11319					
<b>Mt 7</b>							

11420...11439	Range of changes as in registers 11300 ... 11319				
<b>Mt 8</b>					

11440...11459	Range of changes as in registers 11300 ... 11319				
<b>Mt 9</b>					
11460...11479	Range of changes as in registers 11300 ... 11319				
<b>Mt 10</b>					
11480...11499	Range of changes as in registers 11300 ... 11319				
<b>Mt 11</b>					
11500...11519	Range of changes as in registers 11300 ... 11319				
<b>Mt 12</b>					
11520...11439	Range of changes as in registers 11300 ... 11319				
<b>Mt 13</b>					
11540...11459	Range of changes as in registers 11300 ... 11319				
<b>Mt 14</b>					
11560...11579	Range of changes as in registers 11300 ... 11319				
<b>Mt 15</b>					
11580...11599	Range of changes as in registers 11300 ... 11319				
<b>Mt 16</b>					
11600...11619	Range of changes as in registers 11300 ... 11319				
<b>Mt 17</b>					
11620. 11639	Range of changes as in registers 11300 ... 11319				
<b>Mt 18</b>					
11640...11659	Range of changes as in registers 11300 ... 11319				
<b>Mt 19</b>					
11660...11679	Range of changes as in registers 11300 ... 11319				
<b>Mt 20</b>					
11680...11699	Range of changes as in registers 11300 ... 11319				

Configuration registers of „Scal” scaling functions

Table 23

Register address	Operations	Range	Description	By default
<b>Scal 1</b>				
11800	RW	0...59	No of the logical channel	0
11801	-	-	reserved	
11802	-	-	reserved	
11803	-	-	reserved	
11804	RW	2...20	Number of points of multi-points characteristics	0
11805	RW	-2147400000 .. 2147400000	Input value 1 Lo x10	0
11806	RW		Input value 1 Hi x10	
11807	RW	-2147400000 .. 2147400000	Output value 1 Lo x10	0
11808	RW		Output value 1 Hi x10	
11809	RW	-2147400000 .. 2147400000	Input value 2 Lo x10	10
11810	RW		Input value 2 Hi x10	
11811	RW	-2147400000 .. 2147400000	Output value 2 Lo x10	10
11812	RW		Output value 2 Hi x10	
11813	RW	-2147400000 .. 2147400000	Input value 3 Lo x10	0
11814	RW		Input value 3 Hi x10	
11815	RW	-2147400000 .. 2147400000	Output value 3 Lo x10	0
11816	RW		Output value 3 Hi x10	

## User's manual

11817	RW	-2147400000 ..	Input value 4 Lo x10	0
11818	RW	2147400000	Input value 4 Hi x10	

11819	RW	-2147400000 ..	Output value 4 Lo x10	0
11820	RW	2147400000	Output value 4 Hi x10	
11821	RW	-2147400000 ..	Input value 5 Lo x10	0
11822	RW	2147400000	Input value 5 Hi x10	
11823	RW	-2147400000 ..	Output value 5 Lo x10	0
11824	RW	2147400000	Output value 5 Hi x10	
11825	RW	-2147400000 ..	Input value 6 Lo x10	0
11826	RW	2147400000	Input value 6 Hi x10	
11827	RW	-2147400000 ..	Output value 6 Lo x10	0
11828	RW	2147400000	Output value 6 Hi x10	
11829	RW	-2147400000 ..	Input value 7 Lo x10	0
11830	RW	2147400000	Input value 7 Hi x10	
11831	RW	-2147400000 ..	Output value 7 Lo x10	0
11832	RW	2147400000	Output value 7 Hi x10	
11833	RW	-2147400000 ..	Input value 8 Lo x10	0
11834	RW	2147400000	Input value 8 Hi x10	
11835	RW	-2147400000 ..	Output value 8 Lo x10	0
11836	RW	2147400000	Output value 8 Hi x10	
11837	RW	-2147400000 ..	Input value 9 Lo x10	0
11838	RW	2147400000	Input value 9 Hi x10	
11839	RW	-2147400000 ..	Output value 9 Lo x10	0
11840	RW	2147400000	Output value 9 Hi x10	
11841	RW	-2147400000 ..	Input value 10 Lo x10	0
11842	RW	2147400000	Input value 10 Hi x10	
11843	RW	-2147400000 ..	Output value 10 Lo x10	0
11844	RW	2147400000	Output value 10 Hi x10	
11845	RW	-2147400000 ..	Min. value for display Lo x10	-9999999
11846	RW	2147400000	Min. value for display Hi x10	
11847	RW	-2147400000 ..	Max value to display Lo x10	9999999
11848	RW	2147400000	Max value to display Hi x10	
11849	RW	0,0x2020 ... 0x7A7A	Unit ASCII 2 and 1 characters	0x2020

11850	RW	0,0x2020 ... 0x7A7A	Unit ASCII 4 and 3 characters	0x2020
11851	RW	0,0x2020 ... 0x7A7A	Unit ASCII 6 and 5 characters	0x2020
11852	RW	0,0x2020 ... 0x7A7A	Unit ASCII 8 and 7 characters	0x2020
11853			reserved	
11854			reserved	
11855			reserved	
11856			reserved	
11857			reserved	
11858			reserved	
11859			reserved	
<b>Scal 2</b>				
11860...11919			Range of changes as in registers 11800 ... 11859	
<b>Scal 3</b>				
11920...11979			Range of changes as in registers 11800 ... 11859	
<b>Scal 4</b>				
11980...12039			Range of changes as in registers 11800 ... 11859	
<b>Scal 5</b>				
12040...12099			Range of changes as in registers 11800 ... 11859	
<b>Scal 6</b>				
12100...12159			Range of changes as in registers 11800 ... 11859	
<b>Scal 7</b>				
12160...12219			Range of changes as in registers 11800 ... 11859	
<b>Scal 8</b>				
12220...12279			Range of changes as in registers 11800 ... 11859	
<b>Scal 9</b>				
12280...12339			Range of changes as in registers 11800 ... 11859	
<b>Scal 10</b>				
12340...12399			Range of changes as in registers 11800 ... 11859	
<b>Scal 11</b>				
12400...12459			Range of changes as in registers 11800 ... 11859	
<b>Scal 12</b>				
12460...12519			Range of changes as in registers 11800 ... 11859	
<b>Scal 13</b>				
12520...12579			Range of changes as in registers 11800 ... 11859	
<b>Scal 14</b>				
12580...12639			Range of changes as in registers 11800 ... 11859	
<b>Scal 15</b>				
12640...12699			Range of changes as in registers 11800 ... 11859	
<b>Scal 16</b>				
12700...12759			Range of changes as in registers 11800 ... 11859	
<b>Scal 17</b>				
12760...12819			Range of changes as in registers 11800 ... 11859	
<b>Scal 18</b>				
12820...12879			Range of changes as in registers 11800 ... 11859	
<b>Scal 19</b>				
12880...12939			Range of changes as in registers 11800 ... 11859	
<b>Scal 20</b>				
12940...12999			Range of changes as in registers 11800 ... 11859	

Table: Configuration registers of „Alarm” alarm functions

Table 24

Register address	Operations	Range	Description	By default
<b>Alarm 1</b>				
13800	RW	0...59	Channel no	0

## User's manual

13801	RW	0...2	Alarm state in case of error (Err, Hi, Lo) 0- no changes	2
-------	----	-------	---	---

			1 - alarm activated 2 - alarm disabled	
13802	RW	0...5	Alarm type 0 - manually disabled 1 - manually enabled 3 - active below the Lo threshold 4 - active above the Hi threshold 5 - active between Lo Hi thresholds 6 - active outside Lo Hi thresholds	0
13803	RW	-2147400000	Lower threshold Lo x10	0
13804	RW	2147400000	Lower threshold Hi x10	
13805	RW	-2147400000	Upper threshold Lo x10	0
13806	RW	2147400000	Upper threshold Hi x10	
13807	RW	0...65000	Hysteresis x10	0
13808	RW	0...65000 s	Alarm activation delay	0
13809	RW	0...65000 s	Alarm de-activation delay	0
13810	RW	0...65000 s	Minimum alarm activation time	0
13811	RW	0...65000 s	Minimum alarm de-activation time	0
13812	RW	0...1	Alarm latching 0- disabled 1- enabled	0
13813	RW	0...1	Maintaining the alarm signalling on the display / in status 0 - disabled 1- enabled	0
13814	RW	0...1	Clearing the alarm / alarm support 0 - no reaction 1- clearing	0
<b>Alarm 2</b>				
13815...13829			Range of changes as in registers 13000 ... 13014	
<b>Alarm 3</b>				
13830...13844			Range of changes as in registers 13000 ... 13014	
<b>Alarm 4</b>				
13845...13859			Range of changes as in registers 13000 ... 13014	
<b>Alarm 5</b>				
13860...13874			Range of changes as in registers 13000 ... 13014	
<b>Alarm 6</b>				
13875...13889			Range of changes as in registers 13000 ... 13014	
<b>Alarm 7</b>				
13890...13904			Range of changes as in registers 13000 ... 13014	
<b>Alarm 8</b>				
13905...13919			Range of changes as in registers 13000 ... 13014	
<b>Alarm 9</b>				
13920...13934			Range of changes as in registers 13000 ... 13014	
<b>Alarm 10</b>				
13935...13949			Range of changes as in registers 13000 ... 13014	
<b>Alarm 11</b>				
13950...13964			Range of changes as in registers 13000 ... 13014	
<b>Alarm 12</b>				
13965...13979			Range of changes as in registers 13000 ... 13014	
<b>Alarm 13</b>				
13980...13994			Range of changes as in registers 13000 ... 13014	
<b>Alarm 14</b>				
13995...14009			Range of changes as in registers 13000 ... 13014	
<b>Alarm 15</b>				
14010...14024			Range of changes as in registers 13000 ... 13014	
<b>Alarm 16</b>				
14025...14039			Range of changes as in registers 13000 ... 13014	
<b>Alarm 17</b>				
14040...14054			Range of changes as in registers 13000 ... 13014	



<b>Alarm 18</b>		
14055...14069	Range of changes as in registers 13000 ... 13014	
<b>Alarm 19</b>		
14070...14084	Range of changes as in registers 13000 ... 13014	
<b>Alarm 20</b>		
14085...14099	Range of changes as in registers 13000 ... 13014	

Registers with inputs/outputs measurement values

Table 25

Register address	Operations	Range	Description	By default
<b>Slot (Z)</b>				
14300	R	0.1	Slot (Z) Out1	
14302	R	0.1	Slot (Z) Out2	
14304	R	0.1	Slot (Z) In1	
14306	R	0.1	Slot (Z) In2	
<b>6 x relay outputs module</b>				
14308	R	0.1	Slot (X) Out 1	
14310	R	0.1	Slot (X) Out 2	
14312	R	0.1	Slot (X) Out 3	
14314	R	0.1	Slot (X) Out 4	
14316	R	0.1	Slot (X) Out 5	
14318	R	0.1	Slot (X) Out 6	
14320	R	0.1	Slot (X) Out 1	
<b>4 x relay outputs module + 4 x binary inputs separated from each others</b>				
14322	R	0.1	Slot (X) Out 2	
14324	R	0.1	Slot (X) Out 3	
14326	R	0.1	Slot (X) Out 4	
14328	R	0.1	Slot (X) In 1	
14330	R	0.1	Slot (X) In 2	
14332	R	0.1	Slot (X) In 3	
14334	R	0.1	Slot (X) In 4	
<b>4 x analogue output module + 4 x binary inputs with common ground</b>				
14336	R	0. 22000	Slot (X) Out 1 (current) (mA x 1000)	
14338	R	0. 22000	Slot (X) Out 2 (current) (mA x 1000)	
14340	R	0. 22000	Slot (X) Out 3 (current) (mA x 1000)	
14342	R	0. 22000	Slot (X) Out 4 (current) (mA x 1000)	
14344	R	0.1	Slot (X) In 1	
14346	R	0.1	Slot (X) In 2	
14348	R	0.1	Slot (X) In 3	
14350	R	0.1	Slot (X) In 4	
<b>4 x programmable measuring inputs module</b>				
14352	R		Slot (X) In 1(measurement value)	
14354	R		Slot (X) In 2(measurement value)	
14356	R		Slot (X) In 3(measurement value)	
14358	R		Slot (X) In 4(measurement value)	
<b>6 x relay outputs module</b>				
14360	R	0.1	Slot (Y) Out 1	
14362	R	0.1	Slot (Y) Out 2	
14364	R	0.1	Slot (Y) Out 3	
14366	R	0.1	Slot (Y) Out 4	
14368	R	0.1	Slot (Y) Out 5	
14370	R	0.1	Slot (Y) Out 6	
<b>4 x relay outputs module + 4 x binary inputs separated from each other's</b>				
14372	R	0.1	Slot (Y) Out 1	
14374	R	0.1	Slot (Y) Out 2	
14376	R	0.1	Slot (Y) Out 3	
14378	R	0.1	Slot (Y) Out 4	

## User's manual

Register address	Operations	Range	Description	By default
14380	R	0.1	Slot (Y) In 1	
14382	R	0.1	Slot (Y) In 2	
14384	R	0.1	Slot (Y) In 3	
14386	R	0.1	Slot (Y) In 4	
<b>4 x analogue output module + 4 x binary inputs with common ground</b>				
14388	R	0..22000	Slot (Y) Out 1 (current) (mA x 1000)	
14390	R	0..22000	Slot (Y) Out 2 (current) (mA x 1000)	
14392	R	0..22000	Slot (Y) Out 3 (current) (mA x 1000)	
14394	R	0..22000	Slot (Y) Out 4 (current) (mA x 1000)	
14396	R	0.1	Slot (Y) In 1	
14398	R	0.1	Slot (Y) In 2	
14400	R	0.1	Slot (Y) In 3	
14402	R	0.1	Slot (Y) In 4	
<b>4 x programmable measuring inputs module</b>				
14404	R		Slot (Y) In 1(measurement value)	
14406	R		Slot (Y) In 2(measurement value)	
14408	R		Slot (Y) In 3(measurement value)	
14410	R		Slot (Y) In 4(measurement value)	

Registers with channels measurement values

Table 26

Register address	Operations	Description	By default
14500	R	Value from channel 1	
14502	R	Value from channel 2	
14504	R	Value from channel 3	
14506	R	Value from channel 4	
14508	R	Value from channel 5	
14510	R	Value from channel 6	
14512	R	Value from channel 7	
14514	R	Value from channel 8	
14516	R	Value from channel 9	
14518	R	Value from channel 10	
14520	R	Value from channel 11	
14522	R	Value from channel 12	
14524	R	Value from channel 13	
14526	R	Value from channel 14	
14528	R	Value from channel 15	
14530	R	Value from channel 16	
14532	R	Value from channel 17	
14534	R	Value from channel 18	
14536	R	Value from channel 19	
14538	R	Value from channel 20	
14540	R	Value from channel 21	
14542	R	Value from channel 22	
14544	R	Value from channel 23	
14546	R	Value from channel 24	
14548	R	Value from channel 25	
14550	R	Value from channel 26	
14552	R	Value from channel 27	
14554	R	Value from channel 28	
14556	R	Value from channel 29	
14558	R	Value from channel 30	
14560	R	Value from channel 31	
14562	R	Value from channel 32	
14564	R	Value from channel 33	
14566	R	Value from channel 34	
14568	R	Value from channel 35	
14570	R	Value from channel 36	

Register address	Operations	Description	By default
14572	R	Value from channel 37	
14574	R	Value from channel 38	
14576	R	Value from channel 39	
14578	R	Value from channel 40	
14580	R	Value from channel 41	
14582	R	Value from channel 42	
14584	R	Value from channel 43	
14586	R	Value from channel 44	
14588	R	Value from channel 45	
14590	R	Value from channel 46	
14592	R	Value from channel 47	
14594	R	Value from channel 48	
14596	R	Value from channel 49	
14598	R	Value from channel 50	
14600	R	Value from channel 51	
14602	R	Value from channel 52	
14604	R	Value from channel 53	
14606	R	Value from channel 54	
14608	R	Value from channel 55	
14610	R	Value from channel 56	
14612	R	Value from channel 57	
14614	R	Value from channel 58	
14616	R	Value from channel 59	
14618	R	Value from channel 60	

## 10 Technical data

Table 27

Sensor type/ Input signal		Standard	Range		Basic error
RTD	PT100	PN-EN 60751:2009	-200...850 °C	-328...1562 °F	0.2%
	PT500		-200...850 °C	-328...1562 °F	0.2%
	PT1000		-200...850 °C	-328...1562 °F	0.2%
Fe-CuNi (J)		PN-EN 60584-1:2014	-100 .. 1200°C	-148...2192 °F	0.2%
Cu-CuNi (T)			-100 .. 400°C	-148...752 °F	0.2%
NiCr-NiAl (K)			-100 .. 1370°C	-148...2498 °F	0.2%
PtRh10-Pt (S)			-5 .. 1760°C	23...3200 °F	0.2%
PtRh13-Pt (R)			-5 .. 1760°C	23...3200 °F	0.2%
PtRh30-PtRh6 (B)			200 .. 1820°C	392...3200 °F	0.5%
NiCr-CuNi (E)			-100 .. 1000°C	-148...1832 °F	0.2%
NiCrSi-NiSi (N)			-100 .. 1300°C	-148...2372 °F	0.2%
Voltage			±10000 mV, ±300 mV, ±75 mV, 10000 mV, 300 mV, 75 mV,		0.2%
Current			±40 mA, 40 mA		0.2%
Resistance R			0 .. 4000 Ω		0.2%

**Reading field** 3.5 "TFT colour graphic screen with a resolution of 320 x 240 Pixels

**Power module**

**Power consumption**

≤ 12 VA

**Serial slave interface RS485**

Modbus RTU 8N2,8E1,8O1,8N1. Address 1..247,  
baud rate 9.6, 19.2, 38.4, 57.6, 115.2 kbit / s,  
maximum time to start the response: 600 ms

**24V sensors power supply output**

24 V d.c. ±10% / max 30 mA

**2 inputs In1, In2**

0...1 V d.c. - inactive binary  
input , 5 ... 24 V d.c. - active  
binary input, power  
consumption: 7.5 mA / 24V

**Relay outputs Out1, Out2**

2 programmable relays, normally open volt-free  
contacts, load capacity (resistance) 0.5 A / 250 V a.c.  
or 5 A / 30 V d.c.

Number of switching: mechanical minimum  $5 \times 10^6$   
electric minimum  $1 \times 10^5$

**Communication module**

**Ethernet**

10/100 Base-T, RJ45 socket, Web server, FTP server,  
Modbus TCP / IP server, DHCP client, NTP client  
For optimal EMC protection, the Ethernet wire should  
be shielded and the shield grounded.

**USB Host:** By using the USB Host interface, the  
user can copy files between the internal memory  
and the device connected to the USB Host

**RS485 master**

Modbus RTU 8N2,8E1,8O1,8N1. Address 1..247,  
baud rate 9.6, 19.2, 38.4, 57.6, 115.2 kbit / s,

**Optional I / O modules (slot X, slot Y):**

**Relay outputs  
module**

**Out1 .. Out6**

programmable relays, normally open volt-free contacts, load  
capacity (resistance) 0.5 A / 250 V a.c. or 5 A / 30 V d.c.  
Number of switching: mechanical minimum  $5 \times 10^6$   
electric minimum  $1 \times 10^5$

**4 x relay outputs module  
+ 4 x binary inputs separated  
from each other's**

**Out1 .. Out4**

programmable relays,  
normally open volt-free contacts, load  
capacity (resistance) 0.5 A / 250 V a.c. or  
5 A / 30 V d.c.

Number of switching:  
mechanical minimum  $5 \times 10^6$   
electric minimum  $1 \times 10^5$

**In1 .. In4**

0...1 V d.c. - inactive binary input , 6 ... 24  
V d.c. - active binary input, power  
consumption: 7.5 mA / 24V

**4 x analogue output module  
+ 4 x binary inputs with common  
ground**

**Out1 .. Out4**

0... 20 mA (4...20mA) programmable.  
Load resistance  $\leq 400 \Omega$   
Available voltage 10 V. Basic error 0.2%.

**In1 .. In4**

0...1 V d.c. - inactive binary input , 6 ... 24  
V d.c. - active binary input, power  
consumption: 7.5 mA / 24V

**4 x universal inputs module /  
temperature, resistance, standard  
signals /**

**In1 .. In4**

4 RTD universal inputs (PT100, PT500, PT1000),  
TC (J, T, K, S, R, B, E, N), voltage  $\pm 75$  mV,  $\pm 300$  mV,  $\pm 10$  V  
current  $\pm 40$  mA, Resistance R (0 .. 4000  $\Omega$ ).

Resistance input current (RTD, R) 175  $\mu$ A Resistance of  
external measuring circuits for RTD inputs and resistance R:  
max 60  $\Omega$  in each wire. The resistance of the supply wires  
should be equal. The difference in the resistance of the  
wires leads to an additional measurement error.

All pins in universal inputs should be plugged in even if  
they are not used for any connections.

## User's manual

---

**Real time clock** ± 20ppm , real clock battery- CR1220

### Recording

Archiving period (registration interval) 1..3600 sec.  
Recording start modes: Manual off, Manual on,  
Below, Above, Inside, Outside,

Time of filling the file archive memory: depending on  
the recording interval and the number of attached  
registration groups, e.g. for the 1 second interval,  
when all 10 registration groups are switched on –

the archive memory will be full in about 60 days.  
8GB file archive memory.

**Protection level provided by the casing** from the frontal side - IP 65  
terminals - IP 20

**Weight** 0.3 kg

**Dimensions** 96 x 96 x 77 mm

### Reference conditions and rated operating conditions

- power supply 85..253 V a.c. (40..50..60..400) Hz or 90..300 V d.c.  
or 20..60 V d.c.
- ambient temperature -10..23 .. + 55° C,  
class K55 according to PN-EN61557-12
- storage temperature -20 .. + 70° C
- humidity 0 .. 40 ..60 ..95% (inadmissible condensation)
- any working position
- heating time 30 min.

**Real time clock battery:** CR1220

### Additional errors:

in% of the basic error

- related to ambient temperature changes <50% / 10°C

**Standards met by the meter****Electromagnetic****compatibility:**

- general requirements PN-EN IEC 61326-1
- resistance in industrial environments according to PN-EN 61000-6-2 resistance to induced common voltages of radio frequency:
  - level 2 in the frequency range 0.15 .. 1 MHz
  - level 3 in the 1 MHz range .. 80 MHz
- noise emission according to PN-EN 61000-6-4

**Safety Requirements:**

according to the PN-EN 61010-1 standard

- isolation between circuits: basic,
- installation category III
- pollution degree 2,
- maximum voltage in relation to earth:
  - for 300 V power circuits and relay outputs
  - for 50 V measuring inputs
  - for RS485, Ethernet, analogue outputs: 50 V
- altitude above sea level <2000m,

## 11 Ordering Code

The ordering code of the KD6 recorder is presented in the table 28.

Table 28

Screen recorder KD6	X	X	X	XX	X	X
<b>Module I/O – slot X:</b>						
without	0					
6 x relay outputs module	1					
4 x relay outputs module + 4 x binary inputs separated from each other	2					
4 x analogue outputs module + 4 x binary inputs with common ground	3					
4 x programmable measuring inputs module	4					
<b>Module I/O – slot Y:</b>						
without		0				
6 x relay outputs module		1				
4 x relay outputs module + 4 x binary inputs separated from each other		2				
4 x analogue outputs module + 4 x binary inputs with common ground		3				
4 x programmable measuring inputs module		4				
<b>Supply voltage:</b>						
85..253 V a.c., 90..300 V d.c.			1			
20..60 V d.c.			2			
<b>Version:</b>						
standard				00		
Custom-made*				XX		
<b>Language Version:</b>						
Multilingual (polish/english)					M	
other*					X	
<b>Acceptance tests:</b>						
With test certificate						0
With calibration certificate						2
Acc. To customers request*						X

\* only after agreeing with a manufacturer

(\*\*) the number in the first position in the code should be greater than (or equal to) the number in the second position:



N/A code	Available code
KD6-01xxxxx	KD6-10xxxxx
KD6-02xxxxx	KD6-20xxxxx
KD6-03xxxxx	KD6-30xxxxx
KD6-04xxxxx	KD6-40xxxxx
KD6-12xxxxx	KD6-21xxxxx
KD6-13xxxxx	KD6-31xxxxx
KD6-14xxxxx	KD6-41xxxxx
KD6-23xxxxx	KD6-32xxxxx
KD6-24xxxxx	KD6-42xxxxx
KD6-34xxxxx	KD6-43xxxxx

### Order Example

When ordering please respect successive code numbers. The code: **KD6-3 1 1 00 M 0** means:

- KD6** – recorder type,
- 3** – 4 x analogue outputs module + 4 x binary inputs with common ground
- 1** – 6 x relay outputs module
- 1** – supply voltage: 85...253 V a.c., 90..300 V d.c.
- 00** – standard version
- M** – Polish / English version
- 0** – with test certificate

**LUMEL**

**LUMEL S.A.**

ul. Słubicka 4, 65-127 Zielona Góra, Poland  
tel.: +48 68 45 75 100, fax +48 68 45 75 508  
[www.lumel.com.pl](http://www.lumel.com.pl)

---

**Technical support:**

tel.: (+48 68) 45 75 143, 45 75 141, 45 75 144, 45 75 140  
e-mail: [export@lumel.com.pl](mailto:export@lumel.com.pl)

**Export department:**

tel.: (+48 68) 45 75 130, 45 75 131, 45 75 132  
e-mail: [export@lumel.com.pl](mailto:export@lumel.com.pl)

**Calibration & Attestation:**

e-mail: [laboratorium@lumel.com.pl](mailto:laboratorium@lumel.com.pl)