

LUMEL

DIGITAL PANEL METER
N32U



CE

USER'S MANUAL

Contents

1 Application.....	3
2 Meter set.....	5
3 Basic requirements, operational safety.....	5
4 Installation.....	5
4.1 Installation method.....	5
4.2 External connection diagram.....	7
4.3 Examples of connecting the external transducers	10
5 Service.....	11
5.1 Description of the frontal plate.....	11
5.2 Buttons' functions.....	13
5.3 Programming meter parameters.....	14
5.3.1 How to change quantity of a selected parameter.....	16
5.3.2 Programmable meter parameters, default parameters.....	17
5.4 Meter functions.....	21
5.4.1 Measurement.....	21
5.4.1.1 Averaging the measuring quantity.....	22
5.4.1.2 Minimum and maximum measuring values.....	23
5.4.1.3 Mathematical functions.....	23
5.4.1.4 Individual characteristic.....	23
5.4.2 Analog output.....	25
5.4.3 Alarm outputs.....	26
5.5 RS-485 interface.....	27
5.5.1 Connection.....	27
5.5.2 Description of the MODBUS protocol implementation.....	28
5.5.3 Implemented functions of MODBUS protocol.....	28
5.5.4 Map of the registers.....	29
5.5.4.1 Registers 4000 – 4054.....	29
5.5.4.2 Registers 4200 – 4233.....	34
5.5.4.3 Registers 7500 – 7515 and 7000 – 7031.....	35
5.5.4.4 Registers 7600 – 7677 and 7200 – 7355.....	35
6 Error codes.....	38
7 Technical data.....	39
8 Ordering code.....	42

1 Application

The N32U meter is a digital panel meter adapted to be fixed to the panel. The N32U meters are designed to measure standard analog signals used in automation and enable the measurement of standardized voltage and current signals, the signals from RTD and thermocouple sensors. The measuring value can be freely converted into the required value using the mathematical functions or an individual characteristic.

Additionally, the meter supports the programmable alarms with the delay activation and deactivation function as well as a memory of the alarm event. The functionality of the meter is complemented by a programmable analog output - RS-485 interface.

The user interface consists four buttons and the high contrast LCD display with backlight. Thanks to the two-line display, it is possible to set the selected unit, display simultaneously the measuring value and the current time, as well as a clear and user friendly menu with simultaneously visible the parameter name and its value.

Features of the N32 meter:

- Universal measuring input including the standard signals used in automation.
- Measuring sensor failure indication.
- High contrast LCD display with built-in backlight.
- Two-line display.
- Programmable unit of measuring value.
- Possibility to simultaneously display a measuring value and time or not converted quantity.
- Programmable displayed precision with automatic setting of a decimal point.
- Possibility to program the measuring range (narrowing).
- Additional measurement of minimum and maximum values during the moving window, with the possibility of programming one of these values to be displayed as the basic one.
- Programmable alarms with the functions of programmable delays of alarm activation and deactivation, triggered by a specific controlling value. Up to 4 relays including up to 3 relays with a switching contact. Possibility to configure each of the alarms to work in a selected mode and to react to any measuring quantity including the current time.
- Possibility to control the alarm outputs (relay) via the RS-485 interface.
- Programmable standard analog outputs enabling the retransmission of a measuring quantity or a selected parameter. Freely programmable output type and conversion

range.

- Built-in by default RS-485 interface with MODBUS RTU protocol support.
- Built-in real-time clock with a built-in automatic change of DST and inversely. The clock can be a parameter which controls the alarms and the value of the analog output signal.
- Possibility to password protect the settings against unauthorized modification.
- Monitoring of set parameters.
- Measuring quantity conversion using the mathematical functions.
- Measuring quantity conversion using the 32 points individual characteristic.
- Programmed averaging time - averaging algorithm in a specified time using standard averaging (determining the number of measurements to be averaged) and averaging based on the moving window algorithm with a given averaging time.
- Signaling of alarm operation by highlighting the number of the active alarm.
- Registration of minimum and maximum measuring value.
- Galvanic separation of the connections: alarm, measurement, analog outputs, auxiliary supply outputs, RS-485 interface and supplying input.
- Protection degree from the front IP65.
- Meter overall dimensions 96 x 48 x 100 (with the terminals).
- The casing is made of a self-extinguishing plastics.
- Wide range of supply voltages.

The view of the N32U meter is shown in Fig. 1.



Fig. 1: View of the N32U meter.

2 Meter set

The meter set includes:

- Meter N32U – 1 pc
- User's manual – 1 pc
- Clamps to fix in the panel – 4 pcs
- Seal – 1 pc

3 Basic requirements, operational safety

In terms of a user safety, the N32U meter meets the requirements of the EN61010-1 standard for the devices intended for use in facilities compliant with the third category of installations.

Comments concerning safety



- Assembly and installation of the electrical connections should be conducted only by a person authorised and certificated to perform assembly of electric devices.
- Always check the connections before turning the meter on.
- The meter is designed for installation and usage in the industrial electromagnetic environment.
- A switch or a circuit-breaker should be installed in the building or facility. It should be located near the device, easily accessible by the operator, and suitably marked.
- Removal of the meter electronics during the warranty period voids the warranty.

4 Installation

4.1 Installation method

The N32U meters are designed to be mounted in a panel. Prior to installation a $92^{+0.6} \times 45^{+0.6}$ mm slot must be made in the panel. The maximum thickness of the panel material cannot exceed 6 mm. The meter should be mounted from the front of the panel with disconnected meter connection strips.

Before inserting the meter into the panel check the correct position of the meter seal and make sure that the edges of the panel are not sharp what could damage the seal. After inserting the meter into the slot, mount it with the mounting brackets provided in the meter set (Fig. 2).

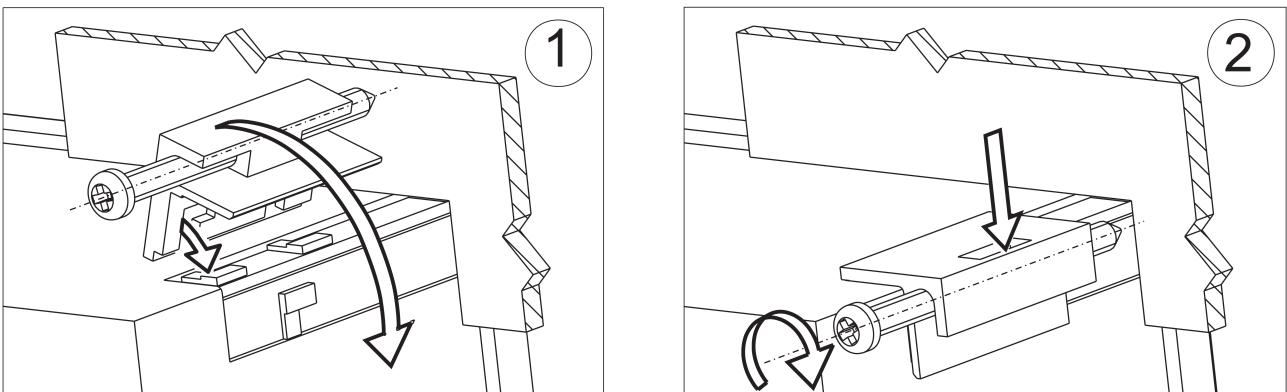

Fig. 2: Meter fixing.

Electrical connections of the meter should be made with the wires with the cross-section up to 2.5 mm². Detachable sockets with the plugs of 5.08 mm pitch can be used for the connections.

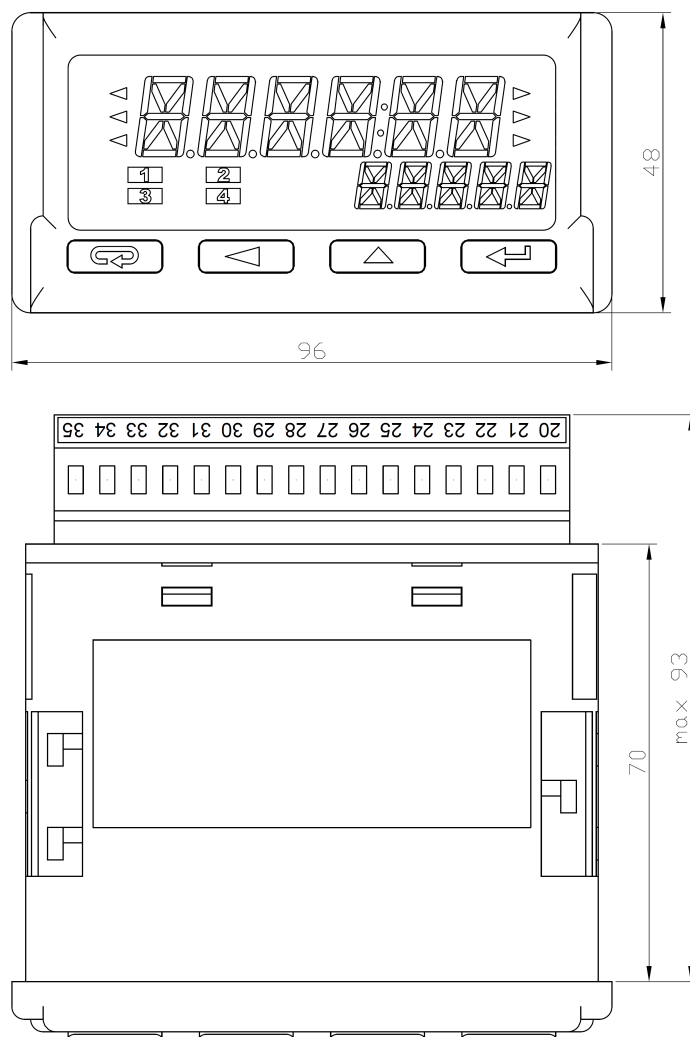

Fig. 3: Meter overall dimensions.

The external dimensions of the meter are shown in Fig. 3.

4.2 External connection diagram

The N32U meter has two detachable terminal strips to connect the wires of a cross-section up to 2.5 mm². The view of the meter from the connectors' side is shown in Fig. 5. The upper terminal strip is optional and depends on the accessories of the meter.

The circuits of successive groups of the terminals are separated from each other, as shown in Fig. 4.



Fig. 4: Galvanic isolation of the N32U meter.

Note: Unused terminals of the terminal strips (NC) must not be connected to any signals.

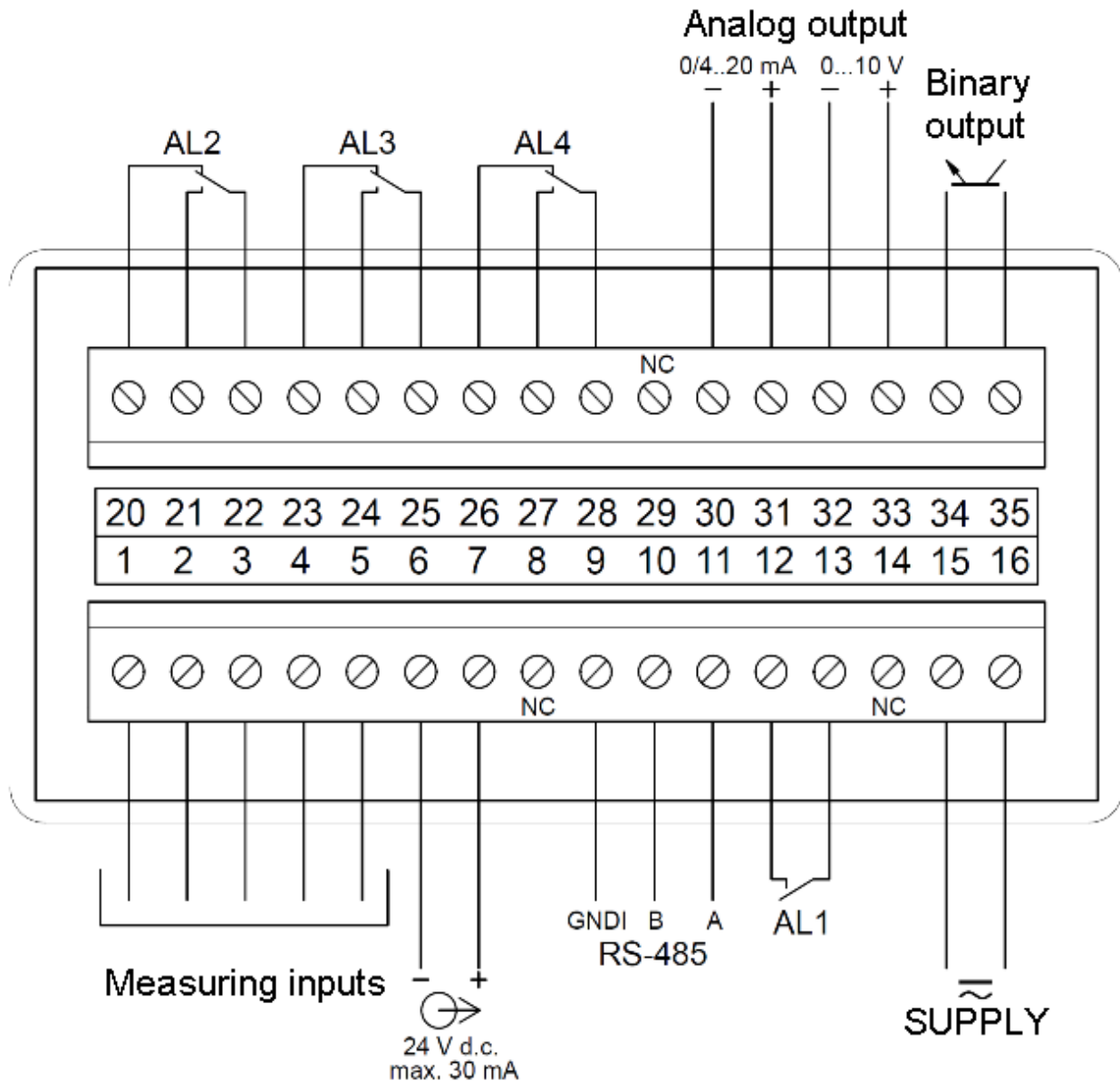

Fig. 5: Signals on the terminal strips.

Detailed description of the signals is shown in the table below, and the connection of the measuring signals is shown in Fig. 6.

Terminal	Function	Description
1, 2, 3, 4, 5	Measuring inputs	Measuring inputs for connecting sensors, transducers or output signals from the other devices. Examples of the connections are shown in Fig. 6.
6, 7	Supply output	Auxiliary supplying output (24 V) for supplying the transducers, e.g. head-mount transducers supplied by a current loop. Maximum current carrying capacity of the output is 30 mA.
9, 10, 11	RS-485	RS-485 interface signals
12, 13	Alarm 1	Alarm output 1, which is NO relay contact.
15, 16	Power supply	Meter power supply connection. Range of supply voltages

		supported by the meter depends on the ordering code. It is required to check if the rated range of the meter corresponds to the installation to which the meter will be connected before installing the meter.
20...28	Alarms 2, 3, 4 (optional)	The alarm outputs 2, 3 and 4 use a relay with a switching contact.
30...34	Analog output	Analog output. The output must be properly connected according to the type of output selected in the configuration (voltage or current): the terminals 30 and 31 for the current output or the terminals 32 and 33 for the voltage output. It is not possible to use the voltage and current outputs at the same time - the correct value in accordance with the configuration, will be available only for the selected output type.
35, 36	Binary output	Open collector binary output for future applications. The output should be left unconnected.
8, 14, 29	NC	Unused terminals. Should be left unconnected.

The connection of the basic measured signals is shown below. The inputs not used in the configuration should be left unconnected.

Standard signals 0...10 V
(Range -13...13 V)

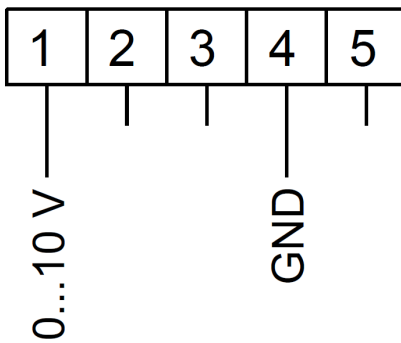

Standard signals 0/4...20 mA
(Range -24...24 mA).

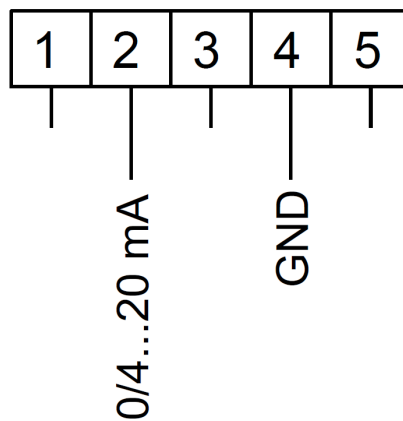

Thermocouples, thermocouple sensors
(thermocouple)

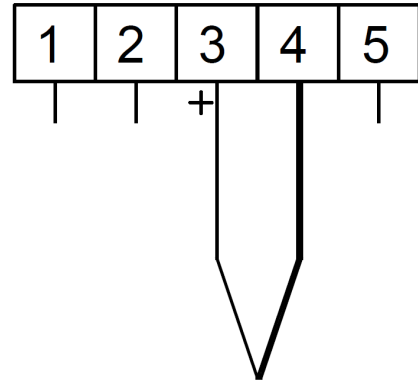

Standard shunts: 60 mV, 150 mV, 300 mV
(Measuring range respectively:
-75...75 mV, -155...155 mV,
-310...310 mV).

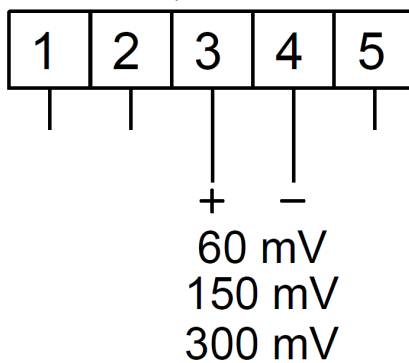

RTD sensors or resistor in 3-wire system.

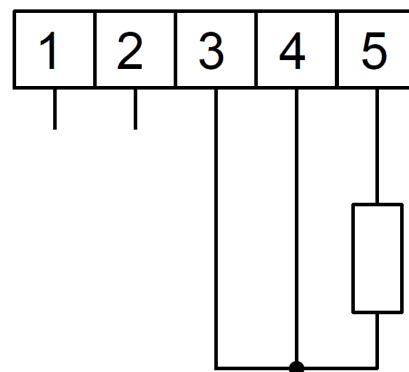

RTD sensors or resistor in 2-wire system.

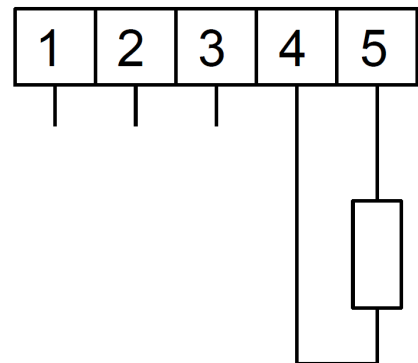

4.3 Examples of connecting the external transducers

Connections of the head-mount transducers when the transducers are supplied directly from the N32 meter are shown below. In the case of the transducers with a voltage output, the maximum current carrying capacity of the auxiliary supply output is 30 mA.

Connecting the transducer supplied by a current loop (2-wire system 4...20 mA).

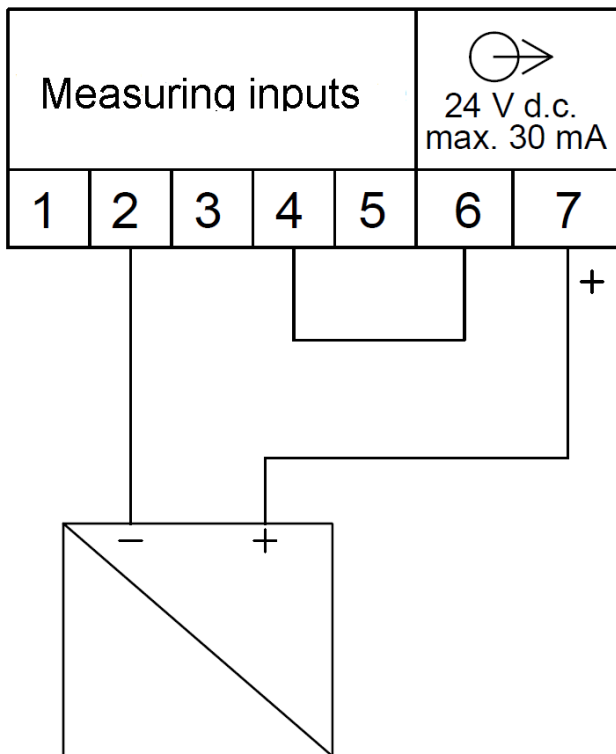

Connecting the transducer with a voltage output in 3-wire system.

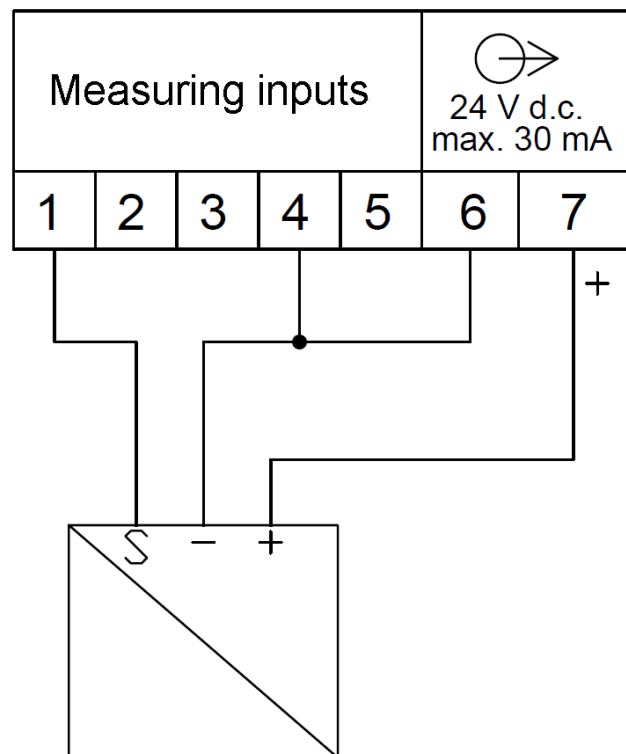

5 Service

The N32 meter user interface includes an LCD display and the buttons which enable to display the measuring value, a full configuration and setting of the meter or modification of the parameters.

After turning the meter on the display shows the name of the meter and the software version. If there is no error during meter initialization process, the meter will switch to displaying the measuring value. If during the initialization any irregularities or deviations are detected, than a message with information about a detected error will be displayed (see point 6 - Error codes).

5.1 Description of the frontal plate

View of the front panel of the meter is shown in Fig. 6. The LCD display with backlight and 4 buttons are on the front panel. The description of the display fields is shown below. The button functions are shown in the section 5.2.

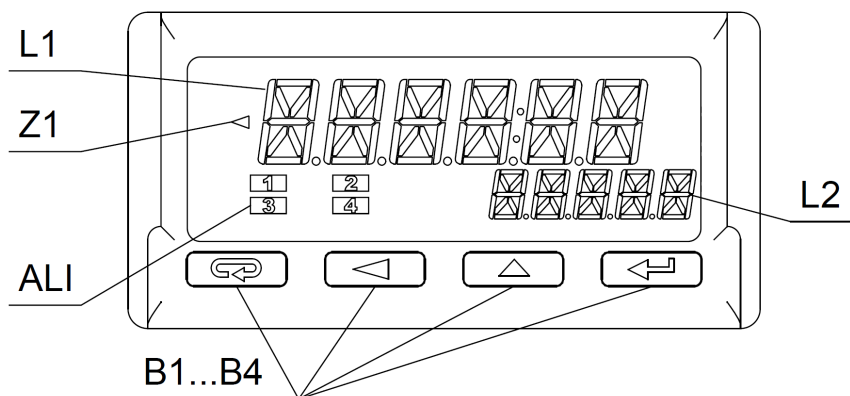

Fig. 6: Front panel of the meter.



Designation	Description
L1	The upper (main) line of the display has 6 characters used to display a measuring value or a parameter value during the meter configuration.
L2	The lower (auxiliary) line of the display has 5 characters used to display a measuring value, not converted by the individual characteristic or, according to configuration, a unit or current time.
Z1	Measuring value averaging indicator. Illuminated averaging indicator informs that the set measuring value averaging period has not elapsed yet.
ALI	Alarm status field. This field contains the indicator informing about the alarm status. Illuminated alarm indicator means that an alarm event is in progress and the relay corresponding to the alarm is activated. Flashing symbol means that the alarm state is saved (if the alarm memory is activated).
B1...B4	Meter operation buttons. The description of the button functions and their various combinations are shown in section 5.2.





The lower line of the display can be configured to display the unit. The available units with the corresponding value in the register 4007 of the MODBUS protocol are shown below.

Value in the register 4007 (setting)	Unit	Value in the register 4007 (setting)	Unit	Value in the register 4007 (setting)	Unit
0	----	20	kvarh	40	h
1	mV	21	Mvarh	41	m ³
2	V	22	VAh	42	rpm
3	kV	23	kVAh	43	pcs
4	mA	24	MVAh	44	pulses
5	A	25	Hz	45	rps
6	kA	26	kHz	46	m/s

7	W	27	Ω	47	l/s
8	kW	28	k Ω	48	rpm
9	MW	29	$^{\circ}\text{C}$	49	m/min
10	var	30	$^{\circ}\text{F}$	50	l/min
11	kvar	31	K	51	pcs/h
12	Mvar	32	%	52	m/h
13	VA	33	%rh	53	km/h
14	kVA	34	pH	54	m ³ /h
15	MVA	35	kg	55	kg/h
16	Wh	36	bar	56	l/h
17	kWh	37	m		
18	MWh	38	l		
19	varh	39	s		

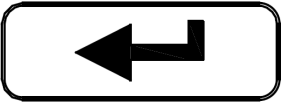
5.2 Buttons' functions

	<p>Cancel button:</p> <ul style="list-style-type: none"> • Exiting the menu and exit to the main screen. • Exiting a lower level of the menu and return to a higher level. • Canceling changing the set value (when editing the parameter value)
	<p>Digit change button:</p> <ul style="list-style-type: none"> • Navigating the menu - decreasing the items of the menu. • Decreasing the controlled quantity while editing a parameter and setting selection from the list of settings, e.g. alarm type. • Changing the controlled digit when setting numerical parameters. • Pressing the button during a normal operation displays a minimum value for 2 seconds, then the display returns to displaying a measuring value.
	<p>Increase value button:</p> <ul style="list-style-type: none"> • Navigating the menu - increasing the items of the menu. • Increasing the value of the selected parameter or increasing the value of a digit when changing the numerical value. • Pressing the button during a normal operation displays a maximum value for 2 seconds, then the display returns to displaying a measuring value.

	<p>Confirm button:</p> <ul style="list-style-type: none"> • Entering the programming mode (holding down the button for at least 3 seconds). • Navigating the menu - entering the parameter value editing mode or entering the selected lower level of the menu. • Accepting the changed parameter value.
	<p>Deleting minimum value. DELMIN message is displayed after deleting.</p>
	<p>Deleting maximum value. DELMAX message is displayed after deleting.</p>
	<p>Deleting alarm memory - hold down the buttons for 3 seconds. ClrAL message will be displayed after deleting alarm memory.</p>

All the events of deleting of saved minimum, maximum values and alarm activation memory are indicated by the meter by displaying an appropriate message.

5.3 Programming meter parameters

Programming meter parameters is possible via the RS485 interface and by direct edition of the parameters using the buttons and the meter display.

Direct programming process is easy thanks to meter menu, which includes the settings grouped into sections with all parameters related to a given functionality, e.g. all parameters of the serial interface are grouped in the menu **RS485**.

Switching from a normal operation to meter menu is possible by pressing and holding for at least 3 seconds the confirm button . If access to change the parameters is password protected, the user will be requested to enter the access password before entering the menu. Entering an incorrect password will allow to enter the menu but it will be not possible to change the parameters - parameters monitoring mode. Entering a correct password will allow to move to a programming matrix, the menu after entering the programming mode is shown below.





Fig. 7: View of meter menu.

While navigating the meter main menu with the groups of the parameters, the upper line of the display shows the name of the group and the lower line continuously displays the word



























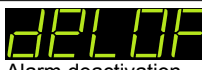



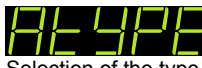

MENU. After entering the group of the parameters (after pressing the confirm button), the upper line displays the value of a given setting and the lower line shows the name of the parameter which value is displayed in the upper line. Sample view of the selection of the measured input signal type is shown in Fig. 8.





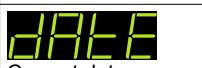

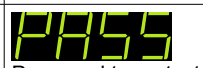
Fig. 8: View of menu when setting a parameter.



The buttons   allow to navigate the menu of the meter. After selecting the group of the parameters which configuration is to be changed, press the confirm button to move to the parameters of the group. The parameter which value is to be modified is selected the same way as the selection of the group. To cancel the parameter change, press the cancel button  to exit the parameter changing mode or the parameter group. The transducer will automatically exit the programming mode and return to displaying the measuring value if no button is pressed for 30 seconds during programming. The programming matrix is shown below.

INPU	1E4PE Input type selection (measuring signal or sensor).	SAVC Standard averaging - number of the measurements to be averaged.	MAVC Moving window method averaging - number of the measurements to be averaged (window width).	COMP Compensation method selection - important parameter for temperature measurement sensors (thermorestors and thermocouple sensors).	MCOMP Compensation value for manual compensation method of wires resistance or terminals temperature.
	MATH Mathematical function selection based on which the measuring value should be converted				
Ind CH	IndCH Enabling or disabling the individual characteristic.	P CNE Number of points of the individual characteristic.	X01 Measuring value - point no. 1.	Y01 Expected value for the measuring value X1.	X02 Measuring value - point no. 2.
	Y02 Expected value for the measuring value X2.	X32 Measuring value - point no. 32.	Y32 Expected value for the measuring value X32.

	 Selection of main displayed value.	 Minimum value on the display. For values lower than this value, a lower overrun message is displayed.	 Maximum value on the display. For values higher than this value, an upper overrun message is displayed.	 Resolution - position of the decimal point.	 The unit which can be displayed in the lower line (when displaying the measuring value).
	 Function of a lower line of the display - selection of a quantity displayed in the lower line.				
   	 Selection of quantity controlling the alarm state.	 Selection of alarm type.	 Alarm state change lower threshold.	 Alarm state change upper threshold.	 Alarm activation delay.
	 Alarm deactivation delay.	 Active alarm memory.			
	 Meter network address.	 Transmission frame type - data format.	 Baud rate.		
	 Selection of the type of analog output used.	 Selection of value controlling the analog output.	 Value of the controlling quantity for which the output will have a minimum value, in accordance with the selected output type.	 Value of the controlling quantity for which the output will have a rated value, in accordance with the selected output type.	 Value on the analog output in case of manual control or an error on the measuring input.
	 Current time according to the internal clock.	 Current date according to the internal clock.	 Automatic change of DST and inversely	 Password to protect against settings modification.	 Restore default settings





5.3.1 How to change quantity of a selected parameter

To increase the value of the selected parameter, press the button . Pressing the button will increase the currently set digit by 1 and after reaching the value 9, pressing the button will set the value 0. After setting the required value of a digit, move to the next digit by pressing the button . After setting the required parameter value, press the confirm button  to accept the entered value or the cancel button  to cancel the parameter change and return to the previous value of the parameter. It is possible to change a sign of the entered value during setting the last digit (most significant).

There are two steps to change the floating point values. The first step is to set the digits and a sign in accordance with the algorithm described above. The second step is set the position of the decimal point after pressing the confirm button. The buttons   are used to set the position of the decimal point. Press the confirm button after setting the

decimal point on the desired position.





Entering an incorrect value of a given parameter causes that the new value is not accepted and the parameter will automatically have the previous value.

To change the parameters other than numerical select the appropriate setting from the parameter list using the buttons  . After selecting the appropriate setting, press the confirm button  to use the setting or the cancel button  to return to the previous value and exit the parameter change mode.

5.3.2 Programmable meter parameters, default parameters

The N32U meters have a number of programmable parameters, which enable the meter to be adapted to the requirements of application. The parameters grouped according to the menu are shown in the tables below.

Table 1

		
Parameter symbol	Description	Range of changes
	Type of connected input signal - measuring input type selection.	<p>Default: 10V</p> <p>Pt100 – PT100 Pt1000 – PT1000 REZ-L – resistance measurement, range of 400 Ω REZ-H – resistance measurement, range of 4,000 Ω tC-E – thermocouple type E (NiCr-CuNi) tC-J – thermocouple type J (Fe-CuNi) tC-K – thermocouple type K (NiCr-NiAl) tC-N – thermocouple type N (NiCrSi-NiSi) tC-R – thermocouple type R (PtRh13-Pt) tC-S – thermocouple type S (PtRh10-Pt) 60MV – voltage measurement, range 60 mV 150MV – voltage measurement, range 150 mV 300MV – voltage measurement, range 300 mV 10V – voltage measurement, range 10 V 20MA – current measurement, range 20 mA 4_20MA – current measurement, range 4...20 mA</p>
	Time of a single measurement as a multiple of 100 ms (200 ms for enabled automatic compensation for RTD sensors or resistance measurement).	<p>Default: 10</p> <p>1...600</p>
	Number of the item for moving window method averaging. Each item is a measurement taken in SAVG time.	<p>Default: 1</p> <p>1...3600</p>
	Selection of resistance compensation method of the connection cables during resistance or temperature measurements using RTD sensors or terminals temperature compensation for temperature measurement with thermocouple sensors.	<p>Default: AUTO</p> <p>AUTO – automatic compensation of the terminals temperature is enabled (for measurements using the thermocouples) or cables resistance compensation for resistance measurements (a 3-wire system is required). MANUAL – manual compensation of the measuring value. The temperature value of the terminals is determined by MCOMP setting for measurements using the thermocouples. The resistance value of connecting cables is determined by MCOMP setting for resistance measurements.</p>



	The resistance of the connecting cables or terminals temperature during manual compensation (MANUAL).	<p>Default: 0</p> <p>-30...70 – for the input set to measure using the thermocouples. 0...20 – for resistance measurement or temperature measurement using the RTD sensors.</p>
	Mathematical function selection which should be applied for the measuring value. The mathematical function is applied before the value is converted by the individual characteristic.	<p>Default: NONE</p> <p>NONE – no additional mathematical operations. Sqr – measuring value is squared. Sqrt – square root of the measuring value. Inv – reciprocal of the measuring value. InvSq – reciprocal of the measuring value is squared. InvSt – square root of reciprocal of the measuring value.</p>

Table 2











		
Parameter symbol	Description	Range of changes
	Enable or disable the individual characteristics. The OFF setting makes possible to disable the individual characteristic function.	<p>Default: OFF</p> <p>OFF – individual characteristic disabled. ON – individual characteristic enabled.</p>
	Number of points of the individual characteristic.	<p>Default: 2</p> <p>2...32</p>
	The first point of the individual characteristic - the value measured directly or the value converted by the mathematical function.	<p>Default: 0</p> <p>-99999...999999</p>
	The first point of the individual characteristic - expected value for the value X1.	<p>Default: 0</p> <p>-99999...999999</p>
<p>...</p>		
	Last possible point of the individual characteristic.	<p>Default: 31</p> <p>-99999...999999</p>
	Last possible point of the individual characteristic – expected value for X32.	<p>Default: 31</p> <p>-99999...999999</p>

Table 3

		
Parameter symbol	Description	Range of changes
	Selection of the main value displayed on the top line of the display.	<p>Default: VALIND</p> <p>VALIND – averaged value of the measuring quantity, converted by the mathematical functions and converted by the individual characteristic. MIN_MW – minimum value registered during the averaging period of the moving window method (during the window) MAX_MW – maximum value registered during the averaging period of the moving window method (during the window) Note: The window length can be programed (MAVG parameter).</p>
	Display narrowing lower threshold. If the value to be displayed is below the threshold, the lower limit symbol is displayed 	<p>Default: -99999</p> <p>-99999...999999</p>





	Display narrowing upper threshold. If the value to be displayed is above the threshold, the upper limit symbol is displayed.	Default: -99999 -99999...999999
	Resolution, display format as the position of the decimal point.	Default: 0000.00 000000 00000.0 0000.00 000.000 00.0000 0.00000 AUTO – automatic position of the decimal point for maximum possible resolution.
	Value selection which should be displayed in the lower line of the display if the displaying a unit is selected as a function.	Default: "-----" The list of available units is provided in Section 5.1.
	Selection of the parameter displayed in the lower line of the display.	Default: UNIT UNIT – unit noIND – measuring value not converted by the individual characteristic (averaged based on the settings) clock – current time.

Table 4









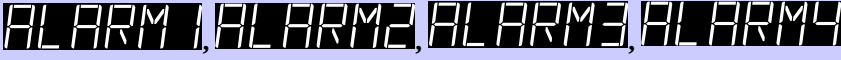

		
Parameter symbol	Description	Range of changes
	Input value controlling the alarm.	Default: VALIND VALIND – measuring value, averaged, converted by the mathematical functions and the individual characteristic. VALAVG – measuring value, averaged, not converted by the mathematical functions or the individual characteristic. VAL – measuring value. As above but not averaged.
	Alarm type (see section 5.4.3)	Default: H-oFF n-on – normally enabled n-oFF – normally disabled on – enabled oFF – disabled H-on – permanently enabled (manually) H-oFF – permanently disabled (manually) REG – the state controlled by the MODBUS protocol register.
	Alarm state change lower threshold.	Default: 10 -99999...999999
	Alarm state change upper threshold.	Default: 20 -99999...999999
	Alarm activation delay - the duration in seconds of the alarm state before activating the alarm relay.	Default: 0 0...900
	Alarm deactivation delay - the duration in seconds the state without the alarm before deactivating the alarm relay.	Default: 10 0...900
	Alarm signalization latch. When the function is enabled, after the alarm event ends, the display indicator informing about the alarm status will be flashing signaling the alarm until it is canceled by a combination of buttons   or via the RS-485 interface.	Default: OFF ON – alarm memory is activated. OFF – alarm memory is deactivated.

Table 5

RS485		
Parameter symbol	Description	Range of changes
Addr	MODBUS network meter address	Default: 1 1...247
Mode	The transmission frame type of RS-485 interface. Setting the parity bits and the number of stop bits.	Default: F8N1 F8N1 F8N2 F8O1 F8E1
Baud	RS-485 interface baud rate.	Default: 9.6k 2.4k – 2400 b/s 4.8k – 4800 b/s 9.6k – 9600 b/s 14.4k – 14400 b/s 19.2k – 19200 b/s 28.8k – 28800 b/s 38.4k – 38400 b/s 57.6k – 57600 b/s 115.2k – 115200 b/s

Table 6

AnOut		
Parameter symbol	Description	Range of changes
ATYPE	Selection of the operating mode and the type of analog output used with the option of switching off the output and manual setting the output value.	Default: OFF OFF – Output support is disabled. 4 20MA – current output 4...20 mA. 0 20MA – current output 0...20 mA. 0 10V – voltage output 0...10 V. MAN I – current output. The output value corresponds to the AnMAN setting. MAN U – voltage output. The output value corresponds to the AnMAN setting.
InPV	Input quantity controlling the analog output	Default: VALIND VALIND – measuring value, averaged, converted by the mathematical functions and the individual characteristic. VALAVG – measuring value, averaged, not converted by the mathematical functions or the individual characteristic. VAL – measuring value. As above but not averaged.
AnLo	Displayed (measured) value for which the analog output will have a rated minimum value, in accordance with the programmed output type.	Default: 0 -99999...999999
AnHi	Displayed (measured) value for which the analog output will have a rated maximum value, in accordance with the programmed output type.	Default: 100 -99999...999999
AnMAN	Value of the signal on the analog output for output value manual control. Note: The value is set on the analog output after detecting an error on the measuring input. The maximum possible signal will be generated if the value exceeds the maximum value for a given output type.	Default: 0 0...22

Table 7

SYSTEM		
Parameter symbol	Description	Range of changes
TIME	Setting the current time. Confirmation of the time resets the seconds counter.	Default: (not applicable) 00:2359
DATE	Setting the current date in YYYY.MM.DD format, where: YY – year. MM – month. DD – day of the month.	Default: (not applicable) 00.01.01...99.12.31
Auto	Automatic change of DST and inversely	Default: OFF OFF – automatic time change disabled. ON – automatic time change enabled.
PASS	Password to access the meter configuration. When the set value is different from zero, each attempt to enter the menu of the meter will require entering a password. In case of providing an incorrect password, it will be possible to enter the menu in the monitoring mode without a possibility of make any changes.	Default: 0 0...9999
FACT	Restore default settings. Selecting YES setting will restore all settings to the default settings and set FACT setting to NO.	Default: NO NO – do nothing. YES – restore default settings (factory).

5.4 Meter functions

5.4.1 Measurement

The N32U meters continuously measure the selected quantity, which is averaged in a given period, and convert it according to the selected mathematical function, and then convert it based on the individual characteristic. If the automatic resistance compensation of the connection cables is enable, an additional test of the cables resistance is made, which affects the speed of measurements, and in this case, the measurement takes 200 ms. In the case of temperature compensation of the terminals of the input configured for temperature measurement with a thermocouple sensor, the time of a single measurement remains unchanged (100 ms) because a separate measuring system is responsible for the temperature measurement. When shortening the measurement time, it needs to be considered that the shorter the measurement time, the greater the influence of noise on the measuring value, and therefore the lower the stability of indications.

All measuring parameters are available via the RS-485 interface, including the basic measuring values such as resistance and resistance of cables for the measurements using RTD sensors or measured voltage for the thermocouple sensors. Additionally, in order to facilitate a control of the measuring signals, the intermediate measuring values, such as values not converted by the individual characteristic or not averaged, were also stored in MODBUS interface registers (see Section 5.6.4).

The measuring value can also be limited by the user by defining the minimum and

maximum measuring value. Exceeding set lower threshold of the measurement (the measuring value lower than the set limit value) causes to display information about exceeding the lower limit, and exceeding set upper threshold of the measuring range (measuring value greater than the set limit value) causes to display information about exceeding the upper limit.

As mentioned above, the measuring value is several times recalculated. The sequence of operations is shown in Figure 9.

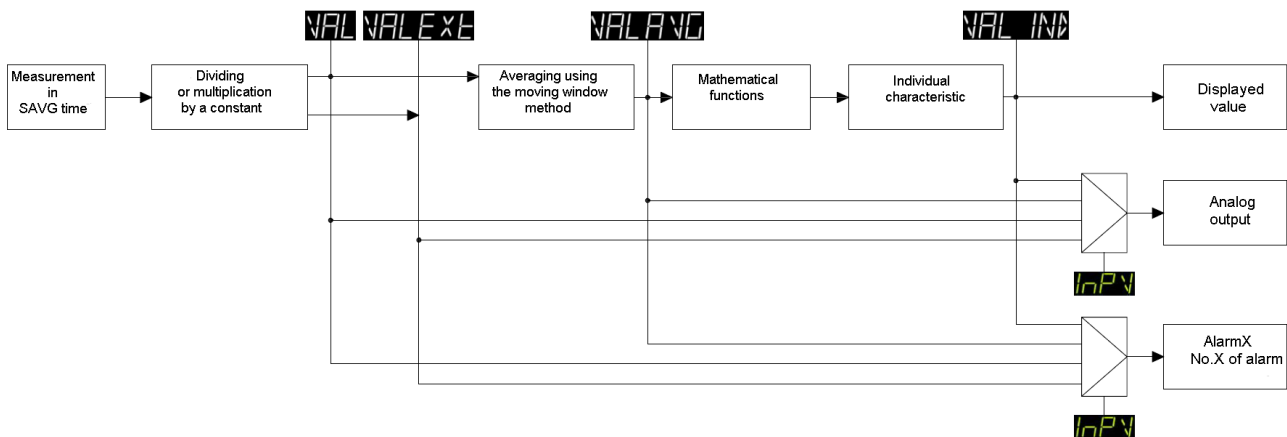



Fig. 9: Measurement recalculation.

Note: The parameter **VAL INP** is unique for the analog output and for each of the alarms, it allows to individually select the parameter controlling the output.

5.4.1.1 Averaging the measuring quantity

The measuring value is averaged in two stage process. The first stage of averaging - the arithmetic mean is calculated from the indicated number of measurements defined by SAVGt parameter. The parameter also determines the time of a single measurement because one measurement takes 100 ms (200 ms for resistance measurement and RTD sensors with enabled automatic compensation), e.g. for measurement of thermocouple sensor type K and the SAVG parameter set to 10, the time of a single measurement will be one second. The next stage of averaging is the averaging using the moving window method, where the individual measurements are stored in the array, so when adding a new item to the array it replaces the oldest item. The average value is calculated every time a new element is stored in the array. The number of array elements (window length) is defined by the user in meter configuration (MAVG parameter). The number of array elements determines the averaging period, because it is a multiple of the time of a single measurement, e.g. for the previous example, setting the MAVG parameter to 60 will set the averaging time at 60 seconds, and the value will be updated every 1 second, i.e. every time a single measurement is done.

5.4.1.2 Minimum and maximum measuring values

The N32 meter continuously measures the signal on the indicated input. The measuring value (displayed) is constantly monitored, if the measuring range is not exceeded during the measurement. If the value is smaller than the current minimal value, then the new minimal value is saved. If the measuring value (displayed) is higher than the current maximum value, the new maximum value is stored. The minimum and maximum value is available via the interface and from the panel of the meter. Press the button  to display the minimum value. Press the button  to display the maximum value. The minimum / maximum value is displayed for 2 seconds, then the meter automatically returns to displaying the measuring value.





Reset of the minimum / maximum value can be done via the interface or directly using the meter keypad. Press a combination of buttons   to reset the minimum value, and press a combination of buttons   to reset the maximum value. Each reset of the minimum or maximum value using the buttons is confirmed by a message - an example the message is shown below.



Fig. 10: The message after resetting the maximum value.

5.4.1.3 Mathematical functions

The N32U meters have a functionality that enables the conversion of the measuring value by the selected mathematical function (MAtH setting):

- Sqr – measured value is squared.
- Sqrt – square root of the measured value.
- Inv – reciprocal of the measured value.
- InvSq – reciprocal of the measured value is squared.
- InvSt – square root of reciprocal of the measured value.

The mathematical functions can be disabled by the setting the parameter MatH to OFF.

5.4.1.4 Individual characteristic

The value measured by the N32U meter can be converted by the individual characteristic. It is important when using the mathematical functions to pay attention to the order of operations - the mathematical functions are completed before the individual characteristic, which should be taken into account when specifying the points coordinates x values. The user can define up to 31 linearization functions by defining 32 points of the characteristic.

The individual characteristic parameters are available from the menu level and via the interface. Programming client-specific characteristic requires to define the number of points and then determining their values. Defining points of the individual characteristic requires to determine the points of the characteristic by providing the X and Y values of each point. The X value of the point is the measuring value converted by the mathematical functions (if they are enabled), while Y value specifies the desired value for the measurement with X value. During a programming, however, the subsequent entered points should meet the dependence:

$$X_1 < X_2 < X_3 < \dots < X_n,$$

where X_n - the last point of the characteristic.

Failure to observe the above dependence will disable the individual characteristic and set the error flag in the meter status register.

An example of the graphic interpretation of the individual characteristic is shown in the Fig. 11.

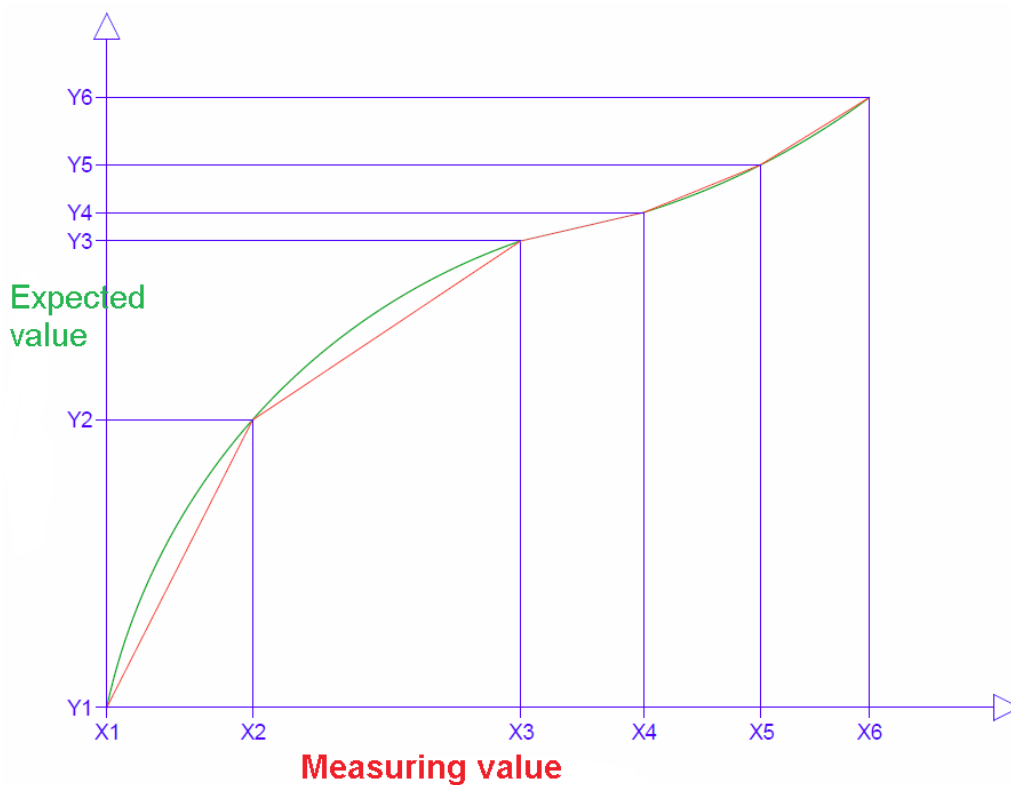

Fig. 11: Example of the individual characteristic.

The approximating functions strongly differ from the linear function, so it is important to keep in mind that the higher the number of the introduced points, the smaller the linearization error of the function.

The value for the measuring values smaller than X_1 is converted according to the first linear function determined on the basis of the points (X_1, Y_1) and (X_2, Y_2) . Similarly, the

conversion for the measured values higher than the last entered point is made using the last selected function.

5.4.2 Analog output

The N32U meters can have one analog output (depends on the ordering code) connected to the meter terminals as a voltage output (0...10 V output) and as a current output (0...20 mA or 4...20 mA). The current output is galvanically separated from the other meter circuits. Selection of the output type to be used can be done during the output configuration. It is not possible to use the voltage and current output at the same time because it is physically one output with two signals connected to the terminals. It is very important when using an output to choose the type of it that is actually being used. Otherwise, the output value will not match the expected output signal.

The following parameters should be defined during the output configuration:

- **AtYPE** – type of output signal that will be used. Additionally, the manual operation modes are available (separate for the voltage output and for the current output), where AnMAN setting defines the exact expected value on the analog output.
- **InPV** – setting which defines the quantity that will control the analog output signal (see Fig. 9).
- **AnLo** – lower value of the control signal in accordance with InPV parameter, which the minimum signal value on the analog output corresponds to.
- **AnHi** – upper value of the control signal in accordance with InPV parameter, which the maximum (rated) signal value on the analog output corresponds to.
- **AnMAN** – the parameter has two applications. First, it is the value of the signal (voltage or current) during a manual control of the output. Second, to use a set value when the signal controlling the output has an incorrect value, e.g. a break in the sensor circuit. In such case the signal on the output will be set according to this setting.

Thus, configuration of the output requires to specify five parameters. An example of an output configuration is shown below.

Let's assume that the input signal is a temperature measured by a PT100 RTD sensor in the range -50...200 °C and for such range the output should change between 4...20 mA. The measuring value is not converted using the mathematical functions or the individual characteristic. The settings for such case should be as follows:

- AtYPE = 4 20MA.
- InPV = VALIND.

- AnLo = -50.
- AnHi = 200.
- AnMAN = 22. The value on the analog output will be 22 mA in case of a measurement error.

5.4.3 Alarm outputs

The N32U meters are equipped with one alarm output as standard. They can have 4 alarm outputs as an option, including three outputs with a switching contact. The alarm output element are electro-magnetic relays. If the meter is physically equipped with one alarm, 4 alarms are still available in the meter menu. In this case, the alarms 2 to 4 can have a indication functions by controlling the alarm indicator on the screen and via the RS-485 interface (alarm states in the meter registers).

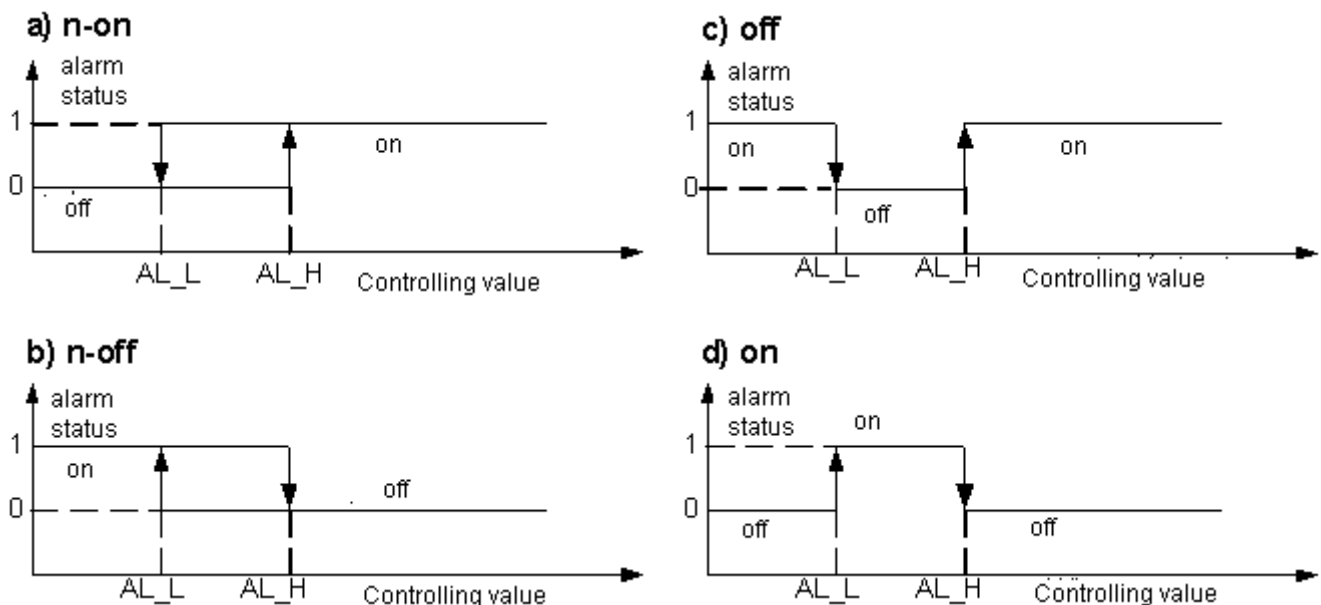

Fig. 12: Alarm types: a) n-on; b) n-off; c) off; f) on.

Each alarm output is independently configured and can be configured to work in one of six modes. It is possible to select the value controlling the alarm (see Fig. 9), define the alarm state change thresholds and define delays alarm activation and deactivation for each of the alarms. Fig. 12 shows how the alarms work in n-on, n-off, off and on modes. Additional manual working modes H-on and H-off enable to permanently activate or deactivate the alarms. An additional REG operation mode has also been added to the alarm type settings. In this mode, the alarm status is controlled via the RS-485 interface by MODBUS protocol registers.

Designations used in the drawing:

- AL_L – corresponds to PrL setting and determines the alarm state change lower threshold.
- AL_H – corresponds to PrH setting and determines the alarm state change upper threshold.

Note: It is important to keep in mind when configuring the alarms that the entered threshold values should match the dependency $AL_L < AL_P$. Otherwise the dependency will disable the alarms.

Additionally, the alarm functions include the programmable delays of alarm activation and deactivation. The user can define how long the alarm event must last before the alarm relay contacts are switched on and the minimum time of the alarm event end before the relay contacts are switched off. Alarm delays prevent false alarms caused by a short-term change of the measuring value, e.g. opening the door to the cold store.

The alarm event could be registered if the alarm memory is enabled.

5.5 RS-485 interface

The N32U meters are equipped as a standard with one RS-485 port connected to the terminals of the lower connector. The interface is galvanically separated from the other circuits of the meter.

The implemented data exchange protocol is compatible with MODBUS RTU standard and allows to save and read all configuration parameters as well as read all measurement data with data including alarm status, current time, date or other parameters related to the meter status. The transducer works in the network as a *slave* device.

Standard RS-485 allows a direct connection up to 32 devices on a single serial link. The maximum permissible cable length depends on a baud rate, and it is 1200 m for the baud rate 9600 b/s. It is necessary to use additional intermediate-separation circuits e.g. PD51 by LUMEL S.A. to connect more devices or to use a longer connections.

5.5.1 Connection

The terminals A, B and GNDI terminals which location is shown in Fig. 5 allow to connect the RS-485 interface to the N32U meter. It is required to connect the lines A and B in parallel with their equivalents in other devices to obtain the correct transmission.

The connection should be made using twisted pair screened cable in such a way that the A and B lines should be one pair and are connected with their equivalents of other devices in the network. The cable shield should be connected to the protective terminal in close proximity to the N32U meter. The cable shield of the interface cable should be connected to the protective terminal only in one point.

The GNDI line, which is the reference potential for the RS-485 interface, is used for additional protection of the interface line at long connections. Then all GNDI lines of all devices using the same bus should be connected together.

A star connection should be avoided when connecting the devices. The connection should have a bus layout which ends are connected to the termination resistors.

Method of connecting the devices is shown in Fig. 13.

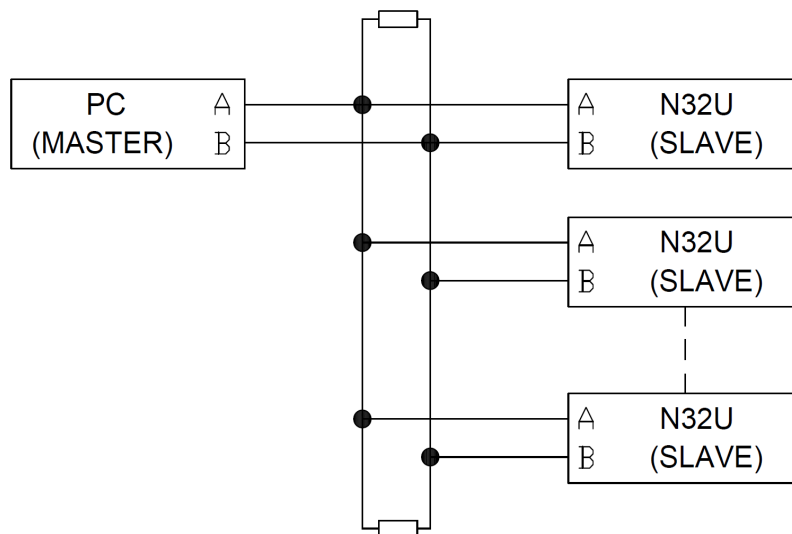

Fig. 13: Connecting the RS-485 interface.

5.5.2 Description of the MODBUS protocol implementation.

The implemented protocol is compliant with the PI-MBUS-300 Rev G specification of Modicon.

It is important to keep in mind when configuring the parameters that the devices using the same bus must meet the following requirements:

- Have a unique address, different from the addresses of other devices connected to the network.
- The same baud rate.
- The same type of transmission mode (single data frame format).

The N32U meters enable programming the following parameters of the RS-485 link:

- Meter address: 1...247.
- Baud rate: 2400, 4800, 9600, 14400, 19200, 28800, 38400, 57600, 115200 [b/s].
- Operation mode: RTU frame format 8n1, 8n2, 8o1, 8e1.
- Maximum response time: 50 ms.

5.5.3 Implemented functions of MODBUS protocol

The following functions of the MODBUS protocol have been implemented in the N32U meters:

- 03 (03h) – readout of registers group.
- 04 (04h) – readout of input registers group.
- 06 (06h) – single register writing.
- 16 (10h) – registers group writing.

- 17 (11h) – *slave* device identification.

5.5.4 Map of the registers

The register map of the N32U meter is divided into separate groups of 16-bit or 32-bit registers. Data stored in 32-bit registers are additionally available in the format of 16-bit registers, with the value of one 32-bit register is stored in two 16-bit registers.

The 32-bit registers store data in the float format compliant with IEEE-754. Bytes sequence: B3 B2 B1 B0 – the oldest byte is transmitted as the first. The 16-bit registers representing 32-bit values in two successive registers have been doubled in another address space with a byte sequence: B1 B0 B3 B2.

The table below shows the register map of the N32U meter. The addresses in the table are the physical addresses. The register number should be increased by 1 when using the programs where the addresses are provided in a logical format.

Address range	Value type	Description
4000 – 4055	16 bits	Readout and write registers - configuration registers
4200 – 4233	16 bits	Readout only registers with system parameter values
7500 – 7515	32 bits (float)	Readout only registers with measuring and calculated values.
7600 – 7677	32 bits (float)	Readout and write registers - registers with configuration data.
7000 – 7031	16 bits	Readout only registers. Registers store the same data as the registers 7500-7515, where one value is stored in two successive registers.
7200 - 7355	16 bits	Readout and write registers. Registers store the same data as the registers 7600-7677, where one value is stored in two successive registers.

5.5.4.1 Registers 4000 – 4054

16-bit readout and write configuration registers.

Address	Permissible values	Default	Description	
Measurement, display and protection of configuration				
4000	0...15	13	Type of measuring input Type of connected input signal	
			Value	Type of signal / range/ sensor
			0	PT100
			1	PT1000
			2	Resistance, range 400 Ω
			3	Resistance, range 4000 Ω
			4	Thermocouple type E
			5	Thermocouple type J
			6	Thermocouple type K
			7	Thermocouple type N
			8	Thermocouple type R
9	Thermocouple type S			
10	60 mV – voltage measurement			

			11	150 mV – voltage measurement
			12	300 mV – voltage measurement
			13	10 V – voltage measurement
			14	0...20 mA – current measurement
			15	4...20 mA – current measurement
4001	1...600	10	Averaging - number of the samples averaged for one measurement. Sampling rate 100 ms (200 ms for the RTD sensors in 3-wire system). The parameter determines time of a single measurement.	
4002	1...3600	1	Number of single measurements averaged using the moving window method.	
4003	0, 1	0	Enable a manual compensation of the terminals resistance or temperature measurement. The value 0 enables an automatic compensation.	
4004	0...5	0	Mathematical functions used for the measuring value.	
			Value	Description
			0	Disabled.
			1	Square of the measuring quantity.
			2	Square root of the measuring quantity.
			3	Reciprocal of the measuring quantity.
			4	Square of the reciprocal of the measuring quantity.
5	Square root of the reciprocal of the measuring quantity.			
4005	0...2	0	Main displayed value on the main display field	
			Value	Description
			0	Value of the measuring quantity, averaged and converted using the mathematical functions and the individual characteristic
			1	Minimum value of the measuring quantity, averaged and converted using the mathematical functions and the individual characteristic, occurring during the averaging window.
2	Maximum value of the measuring quantity, averaged and converted using the mathematical functions and the individual characteristic, occurring during the averaging window.			
4006	0...6	2	Displayed resolution - position of the decimal point.	
			Value	Format
			0	000000
			1	00000.0
			2	0000.00
			3	000.000
			4	00.0000
			5	0.00000
6	Automatic - the position of the decimal point is set for maximum resolution.			
4007	0...2	0	Contents of the bottom line of the display.	
			Value	Description
			0	Unit according to the selected unit (register 4008)
			1	Measuring value without the mathematical operations.

			2	Current time.
4008	0...56	0		Selection of the unit to be displayed in the lower line of the display on the main screen (see register 4006). See point 5.1.
4009	0...9999	0		Access protection code to make changed in the configuration using the meter menu. It would be required to provide a code each time when entering the meter menu in case of entering a value higher than zero.
4010	0, 1	0		Enable the individual characteristics.
			Value	Description
			0	Individual characteristic disabled.
			1	Individual characteristic enabled.
4011	2...32	2		Number of points of the individual characteristic.
Analog output				
4012	0...5	0		Analog output mode.
			Value	Description
			0	Output disabled.
			1	Output mode 4...20 mA.
			2	Output mode 0...20 mA.
			3	Output mode 0...10 V.
			4	Current output controlled manually.
5	Voltage output controlled manually.			
4013	0...3	0		Quantity controlling the analog output signal
			Value	Description
			0	Measuring value, averaged and converted by the individual characteristic.
			1	Current measuring value, converted by the individual characteristic, the mathematical functions without averaging using the moving window function.
			2	Current measuring value without the individual characteristic, the mathematical functions and averaging using the moving window method - measuring value without the mathematical conversions.
			3	Current time
RS-485				
4014	1...247	1		RS-485 – MODBUS network meter address
4015	0...3	0		RS-485 – data transmission frame type (format)
			Value	Frame type
			0	8N1
			1	8N2
			2	8O1
			3	8E1
4016	0...8	2		RS-485 – baud rate.
			Value	Baud rate [b/s]
			0	2400
			1	4800
			2	9600
			3	14400
			4	19200

			5	28800
			6	38400
			7	57600
			8	115200
4017	0, 1	0	RS-485 – Apply entered settings. Entering the value 1 changes immediately the settings and resets the register. If the RS-485 interface parameters have been modified without applying the change, new parameters will be applied after the meter is turned on again.	
Alarm 1				
4018	0..3	0	Value controlling the alarm.	
			Value	Description
			0	Measuring value, averaged and converted by the individual characteristic.
			1	Current measuring value, converted by the individual characteristic, the mathematical functions without averaging using the moving window function.
			2	Current measuring value without the individual characteristic, the mathematical functions and averaging using the moving window method - measuring value without the mathematical conversions.
			3	Current time
4019	0...6	5	Alarm type (see section 5.4.3)	
			Value	Description
			0	n-on
			1	n-off
			2	on
			3	off
			4	H-on – manually disabled
			5	H-off – manually enabled
			6	REG – state controlled by the RS-485 interface
4020	0...900	0	Alarm activation delay in seconds.	
4021	0...900	0	Alarm deactivation delay in seconds.	
4022	0, 1	0	Alarm activation memory. Entering the value 1 activates the alarm event memory function.	
Alarm 2				
4023	0..3	0	Value controlling the alarm, as for the alarm no. 1.	
4024	0...6	5	Alarm type, as for the alarm no. 1.	
4025	0...900	0	Alarm activation delay in seconds.	
4026	0...900	0	Alarm deactivation delay in seconds.	
4027	0, 1	0	Alarm activation memory. Entering the value 1 activates the alarm event memory function.	
Alarm 3				
4028	0..3	0	Value controlling the alarm, as for the alarm no. 1.	
4029	0...6	5	Alarm type, as for the alarm no. 1.	
4030	0...900	0	Alarm activation delay in seconds.	
4031	0...900	0	Alarm deactivation delay in seconds.	
4032	0, 1	0	Alarm activation memory. Entering the value 1 activates the alarm event memory function.	

Alarm 4				
4033	0..3	0	Value controlling the alarm, as for the alarm no. 1.	
4034	0..6	5	Alarm type, as for the alarm no. 1.	
4035	0..900	0	Alarm activation delay in seconds.	
4036	0..900	0	Alarm deactivation delay in seconds.	
4037	0, 1	0	Alarm activation memory. Entering the value 1 activates the alarm event memory function.	
Clock – setting only. The registers store data of last entered time and date.				
4038	0..99	19	Real-time clock – year - value to set the current year.	
4039	1..12	8	Real-time clock – month - value to set the current month.	
4040	1..31	1	Real-time clock – day - value to set the current day.	
4041	0..23	12	Real-time clock – hours - value to set the current hours.	
4042	0..59	0	Real-time clock – minutes - value to set the current minutes.	
4043	0..59	0	Real-time clock – seconds - value to set the current seconds.	
4044	0, 1	0	Automatic change of DST and inversely Entering the value 1 enables the function of automatic change of DST and inversely.	
4045	0, 1	0	Apply entered time. Entering the value 1 sets the clock for the time and date defined in the registers 4037...4042. The register is reset after applying the changes.	
Alarms - Control				
4046	0, 1	0	Alarm 1 - alarm state control for the active alarm in REG mode. Entering the value 1 activates the alarm. Entering the value 0 deactivates the alarm.	
4047	0, 1	0	Alarm 2 - alarm state control for the active alarm in REG mode. Entering the value 1 activates the alarm. Entering the value 0 deactivates the alarm.	
4048	0, 1	0	Alarm 3 - alarm state control for the active alarm in REG mode. Entering the value 1 activates the alarm. Entering the value 0 deactivates the alarm.	
4049	0, 1	0	Alarm 4 - alarm state control for the active alarm in REG mode. Entering the value 1 activates the alarm. Entering the value 0 deactivates the alarm.	
Alarms - Deleting alarm memory				
4050	0, 1	0	Alarm 1 - delete alarm memory. Entering the value 1 deletes the alarm event memory.	
4051	0, 1	0	Alarm 2 - delete alarm memory. Entering the value 1 deletes the alarm event memory.	
4052	0, 1	0	Alarm 3 - delete alarm memory. Entering the value 1 deletes the alarm event memory.	
4053	0, 1	0	Alarm 4 - delete alarm memory. Entering the value 1 deletes the alarm event memory.	
Additional requests				
4054	0, 3	0	Reset minimum / maximum of measuring value. Reset request resets the minimum and maximum values, unless there is no measurement error. Then the reset will be completed after the error is cleared. The value from the register is retrieved and the register is cleared after the request is issued.	
			Value	Description
			0	Do nothing.
			1	Reset a minimum value.

			2	Reset a maximum value.
			3	Reset a minimum and maximum value.
4055	0, 1	0	Restore default settings Entering 1 restores the default settings (default configuration) and resets this register.	

5.5.4.2 Registers 4200 – 4233

Readout only 16-bit registers.

Address	Description	
System parameters		
4200	Device ID	
4201	Software version - version number multiplied by the value 100.	
4202	N32 meter type - code corresponding to the "U" character.	
4203	Meter serial number - older 16 bits.	
4204	Meter serial number - younger 16 bits.	
4205	Meter calibration date - older 16 bits.	
4206	Meter calibration date - younger 16 bits.	
4207	Total meter operation time in seconds - older 16 bits.	
4208	Total meter operation time in seconds - younger 16 bits.	
Real Time Clock		
4209	Current date - year in YY format.	
4210	Current date - month.	
4211	Current date - day.	
4212	Current time - hour.	
4213	Current time - minutes.	
4214	Current time - seconds.	
4215	State of the internal time clock	
	Value	Description
	0	No clock errors.
	1	Lost time settings.
	2	Clock initialization error - faulty clock.
3	Clock setting error.	
Alarms - alarm event memory		
4216	Alarm 1: Value 1 - active mode to register the alarm event. Value zero - no alarm events registered.	
4217	Alarm 2: Value 1 - active mode to register the alarm event. Value zero - no alarm events registered.	
4218	Alarm 3: Value 1 - active mode to register the alarm event. Value zero - no alarm events registered.	
4219	Alarm 4: Value 1 - active mode to register the alarm event. Value zero - no alarm events registered.	
Status bits - value 1 indicates the occurrence of a given event		
4220	Communication error with the internal data memory.	
4221	Corrupted configuration registers from register group 4000.	
4222	Corrupted configuration registers from register group 7600.	
4223	Corrupted calibration registers - no calibration.	
4224	The meter is not calibrated.	
4225	Communication error with the analog output module.	
4226	Measurement module error.	

4227	Measurement error / terminals temperature sensor.
4228	Incorrect configuration of the individual characteristic.
4229	Loss time - not set RTC clock.
4230	Alarm 1 active.
4231	Alarm 2 active.
4232	Alarm 3 active.
4233	Alarm 4 active.

5.5.4.3 Registers 7500 – 7515 and 7000 – 7031

The 32-bit and the corresponding 16-bit registers with measuring and calculated data. The address entered in the address field is for 32-bit float variables or in the second column for the values stored in two 16-bit registers, where the value stored in two registers is of float type.

Address (32-bit float registers)	Address (value in 2 16-bit registers)	Description
7500	7000	Device ID
7501	7002	VAL - Measuring value on the measuring input without the mathematical functions, averaging using the moving window method and without the individual characteristic.
7502	7004	VALAVG - Measuring value on the measuring input without the conversion, but averaged using the moving window method.
7503	7006	Minimum value of the displayed quantity (converted by the mathematical functions, individual characteristics and averaged).
7504	7008	Maximum value of the displayed quantity (converted by the mathematical functions, individual characteristics and averaged).
7505	7010	ALIND - displayed value - measuring value and then averaged, converted by the mathematical functions and converted in accordance with the configuration of the individual characteristic.
7506	7012	Minimum value of VALIND quantity registered during the averaging window (during the selected averaging period).
7507	7014	Maximum value of VALIND quantity registered during the averaging window (during the selected averaging period).
7508	7016	Temperature of meter terminals.
7509	7018	Measured resistance of the wires during resistance measurement in 3-wire system.
7510	7020	Reserved
7511	7022	Reserved
7512	7024	Reserved
7513	7026	Basic measuring value. In the case of temperature measurement using the RTD sensors, it will be the measured value of resistance, using the thermocouple sensors it will be the measured value of voltage in mV.
7514	7028	Compensating measuring value - it is the measured value in the compensation loop in resistance measurements with automatic compensation.
7515	7030	Voltage of the backup battery.
7516	7032	CPU temperature.
7517	7034	Current time in the form of hh.mmss.

5.5.4.4 Registers 7600 – 7677 and 7200 – 7355

The 32-bit and the corresponding 16-bit registers with the configuration parameters. The

address for 32-bit variables was entered in the address field, while the address for accessing data stored in two successive 16-bit registers was entered in a bracket.







Address (32-bit float registers)	Address (value in 2 16-bit registers)	Permissible values	Default	Description
Minimum and maximum displayed value				
7600	7200	-99999...999999	-99999	Display narrowing lower threshold. If the value to be displayed is below the threshold, the lower limit symbol is displayed.
7601	7202	-99999...999999	999999	Display narrowing upper threshold. If the value to be displayed is above the threshold, the upper limit symbol is displayed.
Manual compensation				
7602	7204	-30...70	0	Value of a manual compensation. The value in the register determines the resistance of connection cables for the measurements in the resistance measurement ranges or determines the temperature of the terminals for temperature measurements using the thermocouple sensors.
Analog output				
7603	7206	-99999...999999	0	The quantity of the value controlling the analog output for which the output will have the minimum value (according to the output range).
7604	7208	-99999...999999	100	The quantity of the value controlling the analog output for which the output will have the maximum value (according to the output range).
7605	7210	0...22	0	The value of the analog output signal for manual operation or during a measurement error at the input.
Alarms – alarm state change thresholds				
7606	7212	-99999...999999	10	Alarm 1 – alarm state change lower threshold.
7607	7214	-99999...999999	20	Alarm 1 – alarm state change upper threshold.
7608	7216	-99999...999999	10	Alarm 2 – alarm state change lower threshold.
7609	7218	-99999...999999	20	Alarm 2 – alarm state change upper threshold.
7610	7220	-99999...999999	10	Alarm 3 – alarm state change lower threshold.
7611	7222	-99999...999999	20	Alarm 3 – alarm state change upper threshold.
7612	7224	-99999...999999	10	Alarm 4 – alarm state change lower threshold.
7613	7226	-99999...999999	20	Alarm 4 – alarm state change upper threshold.
Points of the individual characteristic				
Xn - value of the measuring quantity for which Yn value will be displayed on the display				
Yn - displayed value for the measuring value Xn, where n - point number				
7614	7228	-99999...999999	0	X1
7615	7230	-99999...999999	0	Y1
7616	7232	-99999...999999	1	X2
7617	7234	-99999...999999	1	Y2
7618	7236	-99999...999999	2	X3
7619	7238	-99999...999999	2	Y3
7620	7240	-99999...999999	3	X4
7621	7242	-99999...999999	3	Y4
7622	7244	-99999...999999	4	X5
7623	7246	-99999...999999	4	Y5

7624	7248	-99999...999999	5	X6
7625	7250	-99999...999999	5	Y6
7626	7252	-99999...999999	6	X7
7627	7254	-99999...999999	6	Y7
7628	7256	-99999...999999	7	X8
7629	7258	-99999...999999	7	Y8
7630	7260	-99999...999999	8	X9
7631	7262	-99999...999999	8	Y9
7632	7264	-99999...999999	9	X10
7633	7266	-99999...999999	9	Y10
7634	7268	-99999...999999	10	X11
7635	7270	-99999...999999	10	Y11
7636	7272	-99999...999999	11	X12
7637	7274	-99999...999999	11	Y12
7638	7276	-99999...999999	12	X13
7639	7278	-99999...999999	12	Y13
7640	7280	-99999...999999	13	X14
7641	7282	-99999...999999	13	Y14
7642	7284	-99999...999999	14	X15
7643	7286	-99999...999999	14	Y15
7644	7288	-99999...999999	15	X16
7645	7290	-99999...999999	15	Y16
7646	7292	-99999...999999	16	X17
7647	7294	-99999...999999	16	Y17
7648	7296	-99999...999999	17	X18
7649	7298	-99999...999999	17	Y18
7650	7300	-99999...999999	18	X19
7651	7302	-99999...999999	18	Y19
7652	7304	-99999...999999	19	X20
7653	7306	-99999...999999	19	Y20
7654	7308	-99999...999999	20	X21
7655	7310	-99999...999999	20	Y21
7656	7312	-99999...999999	21	X22
7657	7314	-99999...999999	21	Y22
7658	7316	-99999...999999	22	X23
7659	7318	-99999...999999	22	Y23
7660	7320	-99999...999999	23	X24
7661	7322	-99999...999999	23	Y24
7662	7324	-99999...999999	24	X25
7663	7326	-99999...999999	24	Y25
7664	7328	-99999...999999	25	X26
7665	7330	-99999...999999	25	Y26
7666	7332	-99999...999999	26	X27

7667	7334	-99999...999999	26	Y27
7668	7336	-99999...999999	27	X28
7669	7338	-99999...999999	27	Y28
7670	7340	-99999...999999	28	X29
7671	7342	-99999...999999	28	Y29
7672	7344	-99999...999999	29	X30
7673	7346	-99999...999999	29	Y30
7674	7348	-99999...999999	30	X31
7675	7350	-99999...999999	30	Y31
7676	7352	-99999...999999	31	X32
7677	7354	-99999...999999	31	Y32

6 Error codes

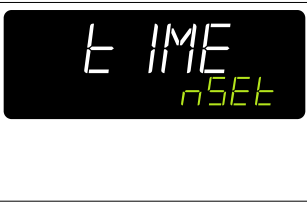
The N32U meters have several diagnostic functions and settings built-in that allow to limit the displaying. So the display may show and the status registers may store information about the diagnosed error, event or fault. Possible messages and their potential causes are listed below.

Message	Description
	Measuring range lower value or the programmed indication range exceeded. The message may also suggest a short circuit in the sensor circuit.
	Measuring range upper value or the programmed indication range exceeded. The message may also suggest a damaged sensor or its incorrect connection (temperature measurement using RTD sensors or thermocouple sensors). The symbol may suggest a break in the measuring circuit or a damaged shunt in the case of measurements in the 60, 150 [mV] ranges.
	It is not possible to display the measuring value in the selected resolution - the measurement result does not fit on the display. Lower the display resolution or select the mode of automatic position of the decimal point.
	Lost calibration. Please contact the technical support.
	Lost real time clock settings. The message is displayed only when turning the meter on. Time and date must be set. If the message still appears when turning the meter on after setting the time and date, please contact the Service Department because a backup battery may require to be replaced. This message can be ignored if the clock settings are not significant in a given application.
	Measurement module error. It is not possible to make a measurement, please contact the technical support.
	Configuration data memory and calibration memory error. It is not possible to use a meter, please contact the technical support.



No communication with the analog output module. Please contact the Service Department.

7 Technical data

Measuring ranges

Input type	Indication range (rated range)	Class
PT100	-200...850 °C (-200...850 °C)	0.1
PT1000	-200...850 °C (-200...850 °C)	
400 Ω	0...480 Ω (0...400 Ω)	
4000 Ω	0...4800 Ω (0...4000 Ω)	
Thermocouple type E	-205...1000 °C (-200...1000 °C)	
Thermocouple type J	-205...1200 °C (-200...1200 °C)	
Thermocouple type K	-205...1372 °C (-200...1372 °C)	
Thermocouple type N	-205...1372 °C (-200...1372 °C)	
Thermocouple type R	-50...1768 °C (-50...1768 °C)	
Thermocouple type S	-50...1768 °C (-50...1768 °C)	
Voltage input 60 mV	-75...75 mV (-60...60 mV)	
Voltage input 150 mV	-155...155 mV (-150...150 mV)	
Voltage input 300 mV	-310...310 mV (-300...300 mV)	
Voltage input 10 V	-13...13 V (-10...10 V)	
Current input 0...20 mA	-24...24 mA (-20...20 mA)	
Current input 4...20 mA	3.6...22.0 mA (4...20 mA)	
Current time	00.00...23.59	

Measuring loops parameters

Current in the sensor circuit during the resistance measurements	175 μA
Input resistance for voltage measurements: thermocouples, 60 mV, 150 mV, 300 mV, 0...10 V	> 1 MΩ
Input resistance for the current ranges	< 11 Ω
Test leads resistance compensation range (maximum resistance of a single lead)	< 20 Ω
Terminals temperature automatic compensation range for measurements using the thermocouple sensors	-30...80 °C

Additional measurement errors

Automatic compensation of reference junction temperature	< 1 °C
Automatic compensation of wire resistance for RTD sensors	< 0.5 °C
Automatic compensation for resistance measurements	< 0.2 Ω (range 400 Ω) < 2 Ω (range 4000 Ω)
Due to ambient temperature changes (main measurement loop and the wires resistance compensation loops)	50% of class / 10 K

RS485 interface

Galvanic separation	From all other signal connections
Protocol	MODBUS RTU
Supported protocol functions	3, 4, 6, 16, 17
Data frame type	8N1, 8N2, 8O1, 8E1
Baud rate [b/s]	2400, 4800, 9600, 14400, 19200, 28800, 38400, 57600, 115200

Alarm outputs:

- NO relay: 5 A / 250 V AC; 5 A / 30 V DC (listed current values are the maximum permissible values. Operation at maximum load significantly shortens lifespan of the relay).
- Three relays with a switching contact (option): 6 A / 250 V AC; 6 A / 30 V DC; 0,15 A / 250 V DC. Maximum switching current 10 A / 20 ms.

Analog output

Voltage output	
Rated range	0...10 V
Maximum output voltage	< 15 V
Minimum load resistance	500 Ω
Intrinsic error	0.1 % of range
Error due to temperature change	50% of intrinsic error value / 10 K
Current output	
Rated range	0...20 mA; 4...20 mA
Maximum output voltage	< 15 V
Maximum load resistance	500 Ω
Maximum current value	24 mA

Intrinsic error	0.1% of range
Error due to temperature change	50% of intrinsic error value / 10 K

Auxiliary supply output

- Voltage source, galvanically separated 24 V \pm 5 %.
- Maximum load capacity 24 V / 30 mA.

Rated operating conditions

Supply voltage (depends on the version)	85...253 V AC (40...400 Hz), 90...300 V DC or 20...40 V AC (40...400 Hz), 20...60 V DC
Power consumption	< 6 VA
Working temperature	-20...23...+55 °C
Storage temperature	-30...70 °C
Humidity	< 95% (no condensation)
Working position	any
Pre-heating time	15 minutes

Protection grade ensured

From the front	IP65
From the terminals side	IP10

Weight and dimensions

Meter weight	< 0.2 kg
Dimensions (see Fig. 3)	96 x 48 x 93 mm

Electromagnetic compatibility

Noise immunity:	acc. to EN 61000-6-2
Noise emission:	acc. to EN 61000-6-4

Safety requirements acc. to EN 61010-1

Circuit-to-circuit insulation:	basic
Installation category:	III

Pollution grade	2
Maximum phase-to-earth operating voltage:	300 V for the circuits: supply, alarm. 50 V for the circuits: measurement*, auxiliary supply, RS-485 interface, analog output
Altitude a.s.l.	< 2000 m

*300 V if +24 V auxiliary voltage output is not used.

8 Ordering code

Panel meter N32U	X	X	XXXXXXXX	X	X
Supply voltage 85..253 V AC, 90...300 V DC 20...40 V AC, 20...60 V DC	1 2				
Outputs / Interface 1 relay output, RS-485 4 relay outputs, RS-485 4 relay outputs, RS-485, 1 analog output		1 2 3			
Version standard custom-made*			0000000 XXXXXXXX		
Language version Polish - English*				M	
Acceptance tests without extra requirements with quality inspection certificate with calibration certificate acc. to customer's request*					0 1 2 X

* only after agreeing with a manufacturer.

LUMEL



LUMEL S.A.

ul. Słubicka 4, 65-127 Zielona Góra, Poland
tel.: +48 68 45 75 100, fax +48 68 45 75 508
www.lumel.com.pl

Technical support:

tel.: (+48 68) 45 75 143, 45 75 141, 45 75 144, 45 75 140
e-mail: export@lumel.com.pl

Export department:

tel.: (+48 68) 45 75 130, 45 75 131, 45 75 132
e-mail: export@lumel.com.pl

Calibration & Attestation:

e-mail: laboratorium@lumel.com.pl