

LUMEL

SPC5 REVERSE POWER CONTROLLER



SERVICE MANUAL

INDEX

Touch Screen Reverse Power Controller Installation & Operating Instructions

| Section | Contents |
|----------------|--|
| 1. | Introduction |
| 2. | Measurement Reading Screens |
| 3. | Programming |
| 3.1 | Password Protection |
| 3.1.1 | Change Password |
| 3.2 | Menu selection |
| 3.2.1 | Grid / Generator Parameters Selection |
| 3.2.1.1 | System type |
| 3.2.1.2 | Potential transformer Primary value |
| 3.2.1.3 | Potential transformer secondary value |
| 3.2.1.4 | Current transformer Primary value |
| 3.2.1.5 | Current transformer Secondary value |
| 3.2.1.6 | System Frequency |
| 3.2.1.7 | Low current noise cutoff |
| 3.2.1.8 | Energy Resolution |
| 3.2.1.9 | Energy Digit Reset Count |
| 3.2.2 | Communication Parameter selection screen |
| 3.2.2.1 | Data RS485 Modbus Setting |
| 3.2.2.1.1 | RS 485 Address Setting |
| 3.2.2.1.2 | RS 485 Baud rate |
| 3.2.2.1.3 | RS 485 Parity & Stop bit Selection |

- 3.2.2.2 Inverter RS 485 Modbus Setting
 - 3.2.2.2.1 RS 485 Baud Rate
 - 3.2.2.2.2 RS 485 Parity & Stop bit Selection
 - 3.2.2.2.3 Delay Between Polls
 - 3.2.2.2.4 Timeout Duration
 - 3.2.2.2.5 Number of Inverters
 - 3.2.2.2.6 Inverter Addresses
- 3.2.3 Solar Parameters
 - 3.2.3.1 Grid Minimum Power
 - 3.2.3.2 Generator Minimum Power
 - 3.2.3.3 Panel Capacities (kW)
 - 3.2.3.4 Solar Power Reference
 - 3.2.3.5 Manual Inverter Power
- 3.2.4 Relay Control
 - 3.2.4.1 Automatic Mode
 - 3.2.4.1.1 Inverter-Grid Relay Parameters
 - 3.2.4.1.1.1 Inverter-Grid Relay ON Delay
 - 3.2.4.1.1.2 Inverter-Grid Relay OFF Delay
 - 3.2.4.1.1.3 Inverter-Grid Relay Configuration
 - 3.2.4.1.2 Inverter-Generator Relay Parameters
 - 3.2.4.1.2.1 Inverter-Gen. Relay Power Threshold
 - 3.2.4.1.2.2 Inverter-Gen. Relay ON Delay
 - 3.2.4.1.2.3 Inverter-Gen. Relay OFF Delay
 - 3.2.4.1.2.4 Inverter-Gen. Relay Configuration
 - 3.2.4.1.2.5 Inverter Power ON Delay
 - 3.2.4.2 Manual Mode
 - 3.2.4.3 Disable Mode
- 3.2.5 Reset Parameter selection screen
 - 3.2.5.1 Resetting Parameter

- 3.2.6 Brightness & Contrast
- 3.2.7 RGB Color Code
- 3.2.8 Factory Reset
- 4. Touch screen calibration
- 5. Phase Sequence Indication screen
- 6. Measurement Screens
 - 6.1 Main Screen
 - 6.2 Grid Menu
 - 6.3 Load Menu
 - 6.4 Solar Menu
 - 6.5 Indications on Main Screen
- 7. Relay Tripping Functionality
- 8. Phasor Diagram
- 9. Installation
 - 9.1 EMC Installation Requirements
 - 9.2 Case Dimensions and Panel Cut-out
 - 9.3 Wiring
 - 9.4 Auxiliary Supply
 - 9.5 Fusing
 - 9.6 Earth / Ground Connections
- 10. Connection Block Diagram
- 11. Wiring Diagram
- 12. Specfication
- 13. Connection for Dual Modbus Addon Card

1. Introduction

This instrument is a panel mounted 96 x 96mm DIN Quadratic Digital metering system for controlling upto 20 Solar Inverters of PVSA make. The instrument is available in two models* : With Generator Sense and Without Generator Sense. The instrument prevents the excess solar power generated by inverters from getting fed back to the grid / generator. The instrument does this by measuring the important electrical parameters like AC voltage, AC Current, Frequency, Active Power, Active Energy at the grid / generator and monitoring the power from solar inverter(s). The instrument integrates accurate measurement (All Voltage & Current measurements are True RMS upto 31st Harmonic) with 320x240 Pixels touch screen TFT LCD display.

This instrument can be configured and programmed at site for the following parameters of grid / generator:

PT Primary, PT Secondary, CT Primary, CT Secondary (5A or1A).

The front panel has a 3.5" Touch Screen through which the user can navigate through the available measurement readings of the Grid / Generator, Solar and Load and configure the product settings.

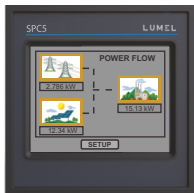

The main screen is divided into 4 submenus, namely GRID / GENERATOR, LOAD, SOLAR & SETUP. Each submenu contains a list of options. By touching the icons cum submenu access buttons on main screen, submenus can be accessed. GRID / GENERATOR submenu can be used to access the power, active energy : import & export and additional grid / generator parameters namely THD, on hour, number of Aux interruptions, voltage, current, etc. LOAD submenu can be used for accessing the Power Contribution of Solar and Grid / Generator to the Load. SOLAR submenu provides all the information about the PV Plant in tabular and graphical form.

***Note : The Generator parameters and settings related to Generator referred to in this booklet are available for the instrument with Generator Sense only.**

TABLE 1 : Measurement Parameters

| Measured Parameters | Units of Measurement |
|---|-----------------------------|
| Grid / Generator Average Voltage | Volts |
| Grid / Generator Average Current | Amps |
| Grid / Generator Voltage VL1-N | Volts |
| Grid / Generator Voltage VL2-N | Volts |
| Grid / Generator Voltage VL3-N | Volts |
| Grid / Generator Voltage VL1-L2 | Volts |
| Grid / Generator Voltage VL2-L3 | Volts |
| Grid / Generator Voltage VL3-L1 | Volts |
| Grid / Generator Current L1 | Amps |
| Grid / Generator Current L2 | Amps |
| Grid / Generator Current L3 | Amps |
| Grid / Generator Neutral Current | Amps |
| Grid / Generator Frequency | Hz |
| Load Active Power | Kwatts |
| Grid / Generator Active Power | Kwatts |
| Grid & Gen. Active Import Energy (8 Digit resolution) | kWh |
| Grid & Gen. Active Export Energy (8 Digit resolution) | kWh |
| Inverter Capacity (Individual & Total) | W |
| Inverter Power (Individual & Total) | W |
| Inverter Target Power (%) | % |
| Individual Inverter Connection Status | — |
| Grid / Generator Individual Harmonics V | % |
| Grid / Generator Individual Harmonics I | % |
| Auxiliary Supply On Hour | Hours |
| Auxiliary Supply Number of Interruptions | Counts |
| Grid / Generator Phase Sequence Indication | — |

TABLE 1 : Continued...

| Measured Parameters | Units of Measurement |
|--------------------------------------|-----------------------------|
| Grid / Generator V1 THD* | % |
| Grid / Generator V2 THD* | % |
| Grid / Generator V3 THD* | % |
| Grid / Generator I1 THD | % |
| Grid / Generator I2 THD | % |
| Grid / Generator I3 THD | % |
| Grid / Generator Average Voltage THD | % |
| Grid / Generator Average Current THD | % |

*Note : THD Parameters are L-N.

2. Measurement Reading Screens

In normal operation the user is presented with one of the measurement reading screens out of several screens. These screens from particular submenu may be scrolled through one at a time in incremental order by touching the "➡" key" and in decremental order by touching "⬅" key" on that screen.

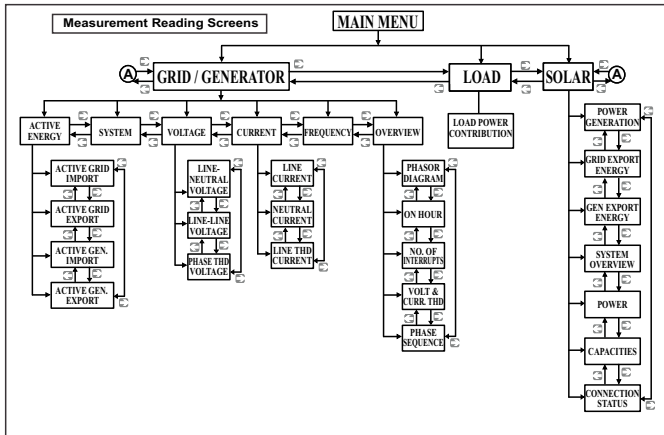

3. Programming

The following sections comprise step by step procedures for configuring the instrument for individual user requirements. To access the set-up screens touch on the "SETUP" button in Main Menu. This will take the User into the Password Protection Entry Stage(Section 3.1).

3.1. Password Protection

Password protection can be enabled to prevent unauthorised access to set-up screens, by default password is "0000".

Password protection is enabled by selecting any four digit number.



After touching "SETUP" button Password protection screen is displayed. Screen consists of 0 to 9 digit input keypad for entering the password very similar to any calculator in touchscreen mobile. "Enter Password" is displayed on screen at start so that user can enter password using displayed keypad.

Touching "1" key" will display 1 in display area, similarly user can enter remaining 3 digits.

For deleting any digit while entering password, user can touch " DEL" key".

After entering the complete password user needs to confirm password by touching " ENTER" key".

Password con rmed.

If Entered password is correct then "Password Accepted" is displayed on screen & user will enter into setup menu.

Password Incorrect.

If Entered password is wrong then "Password Rejected" is displayed on screen & user need to re-enter the password After wrong password is entered, user needs to touch " ENTER" key " for trying another password.

3.1.1 Change Password



Change Password Option is the sixth option in list of "SETUP" submenu, and can be accessed by a simple touch on " Change Password" button. In this screen user rst needs to enter the current password.



After input of correct password, "PASSWORD ACCEPTED" is displayed & now user can enter the new 4 digit password.



New Password confirmed.

After entering new password user needs to touch "  key" to confirm. After confirming "PASSWORD CHANGED" is displayed on screen, which ensures successful changing of the password.

3.2 Menu selection.

After entering in the SETUP SUBMENU, user will be asked to enter password & after input of correct password list of following parameters will be displayed on screen :-

- 3.2.1 GRID / GEN. PARAMETERS
- 3.2.2 COMMUNICATION PARAMETERS
- 3.2.3 SOLAR PARAMETERS
- 3.2.4 RELAY CONTROL
- 3.2.5 RESET PARAMETERS
- 3.1.1 CHANGE PASSWORD
- 3.2.6 BRIGHTNESS & CONTRAST
- 3.2.7 RGB COLOR CODE
- 3.2.8 FACTORY RESET

Touching on GRID / GEN. PARAMETER will open the grid / generator parameters list screen. Then these screens from particular parameter may be scrolled through one at a time in incremental order by touching the "➡ key" and in decremental order by touching "⬅ key" on given touch screen for section 3.2.1 to 3.2.5.

3.2.1 Grid / Gen. Parameters Selection

After entering in the "GRID / GEN. PARAMETERS", List of following parameters will be displayed :-

- 3.2.1.1 SYSTEM TYPE
- 3.2.1.2 PT PRIMARY
- 3.2.1.3 PT SECONDARY
- 3.2.1.4 CT PRIMARY
- 3.2.1.5 CT SECONDARY
- 3.2.1.6 SYSTEM FREQUENCY
- 3.2.1.7 LOW CURRENT NOISE CUTOFF
- 3.2.1.8 ENERGY RESOLUTION
- 3.2.1.9 ENERGY DIGIT RESET COUNT

3.2.1.1 System Type

The System type of the meter is fixed at 3P4W.

3.2.1.2 Potential Transformer Primary Value

The nominal full scale voltage will be displayed as Line to Line Voltages.



This screen can be accessed only from Grid / Gen. Parameters list menu. Here again 0 to 9 digit input keypad is provided to set value of PT Primary, & user can confirm this value with a simple touch "ENTER" key".

"K" key" is used to multiply value by 1000.

In case presently displayed Potential Transformer Primary value together with the Current Transformer Primary value, previously set, would result in a maximum power of greater than 666.6 MVA per phase, "Invalid value" will be displayed. Then the valid range will be displayed.



Valid range of PT primary setting value is

100V L-L to 692.8KV L-L.

If value outside the range is entered, It will display "INVALID VALUE" followed by correct range of parameter.

Note : Changing PT Primary value changes the Generator Minimum Power" (Section 3.2.3.1) and 'Auto-Relay Power Threshold (Gen.)' (Section 3.2.4.1.2.1).

3.2.1.3 Potential Transformer secondary Value

The value must be set to the nominal full scale secondary voltage which will be obtained from the the Transformer when the potential transformer (PT) primary is supplied with the voltage de ned in 3.2.1.2 potential transformer primary voltage. The ratio of full scale primary to full scale secondary is de ned as the transformer ratio.

This screen can be accessed only from grid / generator parameters list menu. Here again 0 to 9 digit input keypad is provided to set value of PT Secondary, & user can confirm this value with a simple touch on "ENTER" key.



The Valid range of instrument is from 100 to 600V.
If value outside the range is entered, It will display "INVALID VALUE" followed by correct range of parameter.

3.2.1.4 Current Transformer Primary Value

The nominal Full Scale Current that will be displayed as the Line currents. This screen enables the user to display the Line currents inclusive of any transformer ratios, the values displayed represent the Current in Amps.

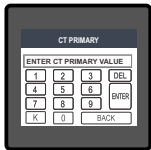

This screen can be accessed only from Grid / Gen.Parameters list menu. Here again 0 to 9 digit input keypad is provided to set value of CT Primary & user can confirm this value with a simple touch on "ENTER" key and "K" key" is used to multiply value by 1000. In case presently displayed Current Transformer Primary Value together with the Potential Transformer Primary Value results in a maximum power of greater than 666.6 MVA, "invalid value" will be displayed. Example: If primary value of PT is set as 692.8kV L-L (max value) then primary value of Current is restricted to 1157A.

The "Maximum Power" restriction of 666.6 MVA refers to 120% of nominal current and 120% of nominal voltage, i.e, 462.96 MVA nominal power per phase.

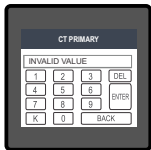

Valid range of CT primary setting value is from 1 to 9999. If value outside the range is entered, It will display "INVALID VALUE" followed by correct range of parameter.

Note : Changing CT Primary value changes the Generator Minimum Power" (Section 3.2.3.1) and 'Auto-Relay Power Threshold (Gen.)' (Section 3.2.4.1.2.1).

3.2.1.5 Current Transformer Secondary Value



This screen is used to set the secondary value for Current Transformer. Two options: 1 AMPERE & 5 AMPERE are displayed on screen. Touching radio button in front of particular option will select that option. Touch on " key" will confirm the setting. Touching the " key" will keep the old selected setting and will return to previous menu.

3.2.1.6 System Frequency

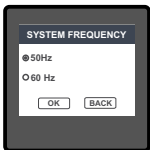

This screen is used to set the frequency of the input. Two options : 50 & 60 Hz are displayed on screen. Touching radio button in front of particular option will select that option. Touch on " key" will confirm the setting. Touching the " key" will keep the old selected setting and will return to previous screen.

3.2.1.7 Low Current noise cutoff



This screen allows the user to set Low noise current cutoff in mA. Two options, 0 MILLI-AMPERE & 30 MILLI-AMPERE are displayed on screen. Touching radio button in front of particular option will select that option. It allows user to set minimum current noise value below which meter shows zero current. Touch on " key" will confirm the setting. Touching the " key" will keep the old selected setting and will return to previous menu.

3.2.1.8 Energy Resolution

This screen enables user to set energy in terms of Wh / kWh / MWh on Modbus (Data RS485) depending on the user requirement.

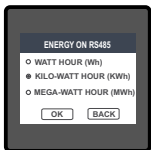

Three options: WATT HOUR, KILO-WATT HOUR & MEGA-WATT HOUR are displayed on screen. Touching radio button in front of particular option will select that option.

Touch on " key" will confirm the setting.

Touching the " key" will keep the old selected setting and will return to previous menu.

Note : Default value is set to 'KILO -WATT HOUR' i.e. Energy on Modbus will be in terms of kWh.

3.2.1.9 Energy Digit Reset Count (Rollover Count)

This screen enables the user for setting maximum energy count after which energy will rollover to zero. This rollover count values are 7, 8 and 9 Digits.

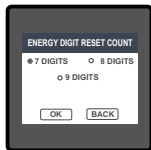

Touching radio button in front of particular option will select that option. Touch on " key" will confirm the setting.

Touching the " key" will keep the old selected setting and will return to previous menu.

Note :-

If Energy Resolution is set to MWh & energy digit reset count is set to 9, Energy screen on display will show "-----" i.e energy over ow when energy crosses the 9 digit count.

3.2.2 Communication Parameter Selection :

After entering in the "COMMUNICATION PARAMETERS" list of following settings are available :

3.2.2.1 DATA RS485 PARAMETERS

3.2.2.1.1 RS485 ADDRESS

3.2.2.1.2 RS485 BAUD RATE

3.2.2.1.3 RS485 PARITY

3.2.2.2 INVERTER RS485 PARAMETERS

3.2.2.2.1 RS 485 BAUD RATE

3.2.2.2.2 RS 485 PARITY

3.2.2.2.3 DELAY BETWEEN POLLS

3.2.2.2.4 TIMEOUT DURATION

3.2.2.2.5 NUMBER OF INVERTERS

3.2.2.2.6 INVERTER ADDRESSES

3.2.2.1 Data RS485 Modbus Setting

3.2.2.1.1 RS485 Address Setting



This screen allows the user to set RS485 address parameter for the instrument, when instrument is used for accessing data and configuration by the user.

Here 0 to 9 digit input keypad is provided to set RS485 address & user can confirm this value with a simple touch on "ENTER" key".



The range of allowable address is 1 to 247.

If value outside the range is entered, it will display "INVALID VALUE" followed by the correct range of parameter.

3.2.2.1.2 RS 485 Baud Rate

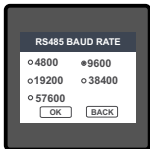

This screen allows the user to set Baud Rate of Data RS 485. Five options: 4800, 9600, 19200, 38400 & 57600 Bauds are displayed on screen. Touching radio button in front of particular option will select that option.

Touch on " key" will confirm the setting.

Touching the " key" will keep the old selected setting and will Return to previous menu.

3.2.2.1.3 RS 485 Parity & Stop bit Selection



This screen allows the user to set Parity & number of stop bits for Data RS485.

Four options: NO PARITY WITH ONE STOP BIT, NO PARITY WITH TWO STOP BITS, EVEN PARITY WITH ONE STOP BIT, ODD PARITY WITH ONE STOP BIT are displayed on screen.

Touching radio button in front of particular option will select that option.

Touch on " key" will confirm the setting.

Touching the " key" will keep the old selected setting and will return to previous menu.

3.2.2.2 Inverter RS485 Modbus Setting

These settings are used for the connection of instrument with the inverters through the dual modbus add-on card.

3.2.2.2.1 RS 485 Baud Rate

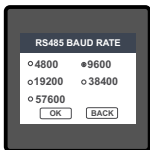

This screen allows the user to set Baud Rate of Inverter RS 485.

Five options: 4800, 9600, 19200, 38400 & 57600 Bauds are displayed on screen. Touching radio button in front of particular option will select that option.

Touch on " key" will confirm the setting.

Touching the " key" will keep the old selected setting and will Return to previous menu.

Note: The Baud Rate of all the inverters (selected in Section 3.2.2.2.5) should be same.

3.2.2.2.2 RS 485 Parity & Stop bit Selection



This screen allows the user to set Parity & number of stop bits of Inverter RS485.

Four options: NO PARITY WITH ONE STOP BIT, NO PARITY WITH TWO STOP BITS, EVEN PARITY WITH ONE STOP BIT, ODD PARITY WITH ONE STOP BIT are displayed on screen.

Touching radio button in front of particular option will select that option.

Touch on “ key” will confirm the setting.

Touching the “ key” will keep the old selected setting and will return to previous menu.

Note: Parity & Number of Stop Bits of all the inverters (selected in Section 3.2.2.2.5) should be same.

3.2.2.2.3 Delay Between Polls



This screen allows the user to set the delay between polls (in milliseconds) sent to the inverters for correct power instructions.

Here 0 to 9 digit input keypad is provided to set the delay between polls & user can confirm this value with a simple touch on “ key”.

The range of allowable value is 10000 msec to 60000 msec.

If value outside the range is entered, it will display “INVALID VALUE” followed by the correct range of parameter. Default value is 30000 msec.

3.2.2.2.4 Timeout Duration



This screen allows the user to set the timeout duration for the modbus connected to the inverters. If an inverter stops communication for time duration more than that set by the user, then the inverter would be considered disconnected.

Here again 0 to 9 digit input keypad is provided to set the timeout duration & user can confirm this value with a simple touch on “ key”.

The range of allowable value is 200 msec to 60000 msec.

If value outside the range is entered, it will display “INVALID VALUE” followed by the correct range of parameter. Default value is 5000 msec.

3.2.2.2.5 Number of Inverters



This screen allows the user to set the number of inverters connected to the instrument.

Here again 0 to 9 digit input keypad is provided to set the number of inverters & user can confirm this value with a simple touch on “ENTER” key”.

The range of allowable value is 1 to 20 inverters.

If value outside the range is entered, it will display “INVALID VALUE” followed by the correct range of parameter. Default value is 1.

3.2.2.2.6 Inverter Addresses



This screen allows the user to set the RS485 address of individual inverters.

A list of 20 inverters with corresponding address appears on screen and touching a particular option would provide a 0 to 9 digit keypad to set the address for the corresponding inverter.



The user can confirm the entered value with a simple touch on “ENTER” key”.

The range of allowable address is 1 to 247.

If value outside the range is entered, it will display “INVALID VALUE” followed by the correct range of parameter.

Note: No two inverters can have the same address and the setting of address is available for all the inverters independent of the number of inverters selected (in Section 3.2.2.2.5).

3.2.3 Solar Parameters

After entering in the "SOLAR PARAMETERS" list of following options will be displayed :

- 3.2.3.1 GRID MINIMUM POWER
- 3.2.3.2 GENERATOR MINIMUM POWER
- 3.2.3.3 PANEL CAPACITIES (kW)
- 3.2.3.4 SOLAR POWER REFERENCE
- 3.2.3.5 MANUAL INVERTER POWER

3.2.3.1 Grid Minimum Power

This screen allows the user to set the minimum power to be consumed from the grid. This value depends upon the load variations : higher the load variation, higher should be the grid minimum power. Meter tries to maintain this amount of power from grid always.

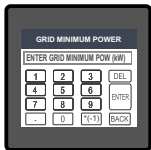

Here 0 to 9 digit input keypad is provided to set the grid minimum power & user can confirm this value with a simple touch on "ENTER" key".

The range of allowable value is -2000 kilo watt to 2000 kilo watts.
If value outside the range is entered, it will display "INVALID VALUE"
followed by the correct range of parameter. Default value is 1 kilo watt.

Note: The negative value indicates export to the grid from solar inverter(s).

3.2.3.2 Generator Minimum Power

This screen allows the user to set the minimum power to be consumed from the generator. This value depends upon the load variations : higher the load variation, higher should be the generator minimum power. Meter tries to maintain this amount of power from generator always.



Here 0 to 9 digit input keypad is provided to set the generator minimum power & user can confirm this value with a simple touch on "ENTER" key".

The range of allowable value is 0 watt to 1000 kilo watts.
If value outside the range is entered, it will display "INVALID VALUE"
followed by the correct range of parameter. Default value depends on PT
Primary and CT Primary according to the relation :

$$\text{Gen. Minimum Power} = \text{CT Pri} * \text{PT Pri} * \text{Root}(3) * 0.7/1000$$

Changing 'Generator Minimum Power' changes the value of 'Auto-Relay Power Threshold (Gen.)' (Section 3.2.4.1.2.1).

3.2.3.3 Panel Capacities (kW)

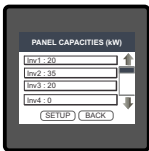

This screen allows the user to set the capacity of panel(s) connected to individual inverter.

A list of 20 inverters with corresponding panel capacity appears on screen and touching a particular option would provide a 0 to 9 digit keypad to set the panel capacity for the corresponding inverter.

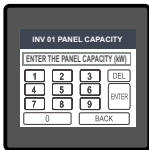

The user can confirm the entered value with a simple touch on " key".

The range of allowable panel capacity is 1 to 200 kilo watt. If value outside the range is entered, it will display "INVALID VALUE" followed by the correct range of parameter.

3.2.3.4 Solar Power Reference

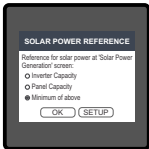

This screen allows the user to set the reference for Generated Inverter Power in the 'SOLAR POWER GENERATION' measurement screen of SOLAR parameters. This setting decides on which basis is the pie chart in the SOLAR POWER GENERATION plotted.

Three options are provided : Inverter Capacity, Panel Capacity or Minimum of Above.

Touch on " key" will confirm the setting and touching the " key" will keep the old selected setting and return to previous menu.

3.2.3.5 Manual Inverter Power



This screen allows the user to set the output power of inverters manually or not. Two options are provided:

1. **Yes** : To set the maximum output power of inverters at a constant percentage of the corresponding Inverter Capacities. The percentage value can be set by touching the bullet in front of the option.
2. **No** : To control the output power of inverters as per the load requirements.

Touch on “ key” will confirm the setting and touching the “ key” will keep the old selected setting and return to previous menu.

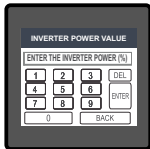

Touching the bullet in front of the Yes option will allow the user to set the value of power in percent.

The user can confirm the entered value with a simple touch on “ key”.

The range of allowable value is 0 to 100 %.

If value outside the range is entered, it will display “INVALID VALUE” followed by the correct range of parameter.

⚠ Caution : If manual inverter power ‘Yes’ is selected, then the instrument would stop controlling inverters as per the load and set the maximum inverter output at the fixed percentage set by the user.

3.2.4 Relay Control

After entering in the "RELAY CONTROL" list of following options with radio button will be displayed :

3.2.4.1 AUTOMATIC

3.2.4.2 MANUAL

3.2.4.3 DISABLE

3.2.4.1 Automatic Mode

This screen allows the user to set the parameters for automatic control of relay based on modbus communications with the inverters and the reverse power flow to the grid or generator separately. It is the default mode. Refer Section 7 'Relay Tripping Functionality'. The settings for relay functioning for Grid and Generator connections are provided separately as 'Inverter-Grid Relay Parameters' (Section 3.2.4.1.1) and 'Inverter-Generator Relay Parameters' (Section 3.2.4.1.2). In case the Grid is connected, parameters in Section 3.2.4.1.1 would be applicable for relay and in case the Generator is connected, parameters in Section 3.2.4.1.2 would be applicable for relay.

3.2.4.1.1 Inverter-Grid Relay Parameters

3.2.4.1.1.1 Inverter-Grid Relay ON Delay

This screen allows the user to set the ON Delay for the relay used in automatic mode for inverter-grid connection.



Here 0 to 9 digit input keypad is provided to set the inverter-grid relay ON Delay & user can confirm this value with a simple touch on "ENTER" key".

The range of allowable value is 1 to 9999 seconds.

If value outside the range is entered, it will display "INVALID VALUE" followed by the correct range of parameter.

The default value is 45 seconds.

Note : Refer Section 7 'Relay Tripping functionality'.

3.2.4.1.1.2 Inverter-Grid Relay OFF Delay

This screen allows the user to set the OFF Delay for the relay used in automatic mode for inverter-grid connection.



Here 0 to 9 digit input keypad is provided to set the inverter-grid relay OFF Delay & user can confirm this value with a simple touch on "ENTER" key".

The range of allowable value is 1 to 9999 seconds.

If value outside the range is entered, it will display "INVALID VALUE" followed by the correct range of parameter.

The default value is 45 seconds.

Note : Refer Section 7 'Relay Tripping functionality'.

3.2.4.1.1.3 Inverter-Grid Relay Configuration

This screen is used to set the Configuration of the relay for inverter-grid connection.



The user can select one of the following configurations:

ENERGIZED RELAY (To Energize the Relay on tripping)

DE-ENERGIZED RELAY (To De-Energized the Relay on tripping)

Touch on "OK" key" will confirm the setting and take back to the previous screen.

Touch on "BACK" key" will take back to the previous screen.

The default configuration is ENERGIZED.

Note : Refer Section 7 'Relay Tripping functionality'.

3.2.4.1.2 Inverter-Generator Relay Parameters

3.2.4.1.2.1 Inverter-Gen. Relay Threshold

If the absolute value of the solar reverse power to the generator is higher than the Inverter-Gen. Relay Threshold value and if at least one of the inverters selected in Section 3.2.2.5 is disconnected, then the relay gets energized/de-energized depending upon the configuration (Section 3.2.4.1.2.4).



Here 0 to 9 digit input keypad is provided to set the inverter-gen. relay threshold & user can confirm this value with a simple touch on “ENTER” key”.

The range of allowable value is 500 to 500000 watts.

If value outside the range is entered, it will display “INVALID VALUE” followed by the correct range of parameter.

The default value depends on Generator Minimum Power as :

$$\text{'Inverter-Gen. Relay Threshold'} = \text{'Generator Minimum Power'} * 1000 / 7$$

Note : Refer Section 7 ‘Relay Tripping functionality’.

3.2.4.1.2.2 Inverter-Gen. Relay ON Delay

This screen allows the user to set the ON Delay for the relay used in automatic mode for inverter-generator connection



Here 0 to 9 digit input keypad is provided to set the inverter-gen. relay ON Delay & user can confirm this value with a simple touch on “ENTER” key”.

The range of allowable value is 1 to 9999 seconds.

If value outside the range is entered, it will display “INVALID VALUE” followed by the correct range of parameter.

The default value is 45 seconds.

Note : Refer Section 7 ‘Relay Tripping functionality’.

3.2.4.1.2.3 Inverter-Gen. Relay OFF Delay

This screen allows the user to set the OFF Delay for the relay used in automatic mode for inverter-generator connection.



Here 0 to 9 digit input keypad is provided to set the inverter-gen. relay OFF Delay & user can confirm this value with a simple touch on "ENTER" key".

The range of allowable value is 1 to 9999 seconds.

If value outside the range is entered, it will display "INVALID VALUE" followed by the correct range of parameter.

The default value is 45 seconds.

Note : Refer Section 7 'Relay Tripping functionality'.

3.2.4.1.2.4 Inverter-Gen. Relay Configuration

This screen is used to set the Configuration of the relay for inverter-generator connection.



The user can select one of the following configurations:

ENERGIZED RELAY (To Energize the Relay on tripping)

DE-ENERGIZED RELAY (To De-Energized the Relay on tripping)

Touch on "OK" key" will confirm the setting and take back to the previous screen.

Touch on "BACK" key" will take back to the previous screen.

The default configuration is ENERGIZED.

Note : Refer Section 7 'Relay Tripping functionality'.

3.2.4.1.2.5 Inverter Power ON Delay

This screen allows the user to set the Inverter Power ON Delay. Radius PVSA inverter delivers the maximum solar power possible immediately after it turns ON and during this time it doesn't follow the instructions from the instrument. This may cause the reverse power to flow to the Generator and may trip the relay (based on settings in Section 3.2.4.1) and further disconnect the Inverter(s) if configured so. This may cause the Inverter(s) to connect and disconnect continuously. So the relay functioning is disabled for Inverter Power ON Delay time set by the user after the Inverters turn ON to prevent the above condition.

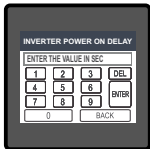

Here 0 to 9 digit input keypad is provided to set the Inverter Power ON Delay & user can confirm this value with a simple touch on “**ENTER**” key”.

The range of allowable value is 10 to 9999 seconds.

If value outside the range is entered, it will display “INVALID VALUE” followed by the correct range of parameter.

The default value is 600 seconds.

3.2.4.2 Manual Mode

This screen allows the user to manually turn the relay ON or OFF.



Touching on Manual mode option of Relay Control menu (Section 3.2.4) and pressing OK will show this screen. The user can select one of the following options for relay:

On (To turn ON the Relay)

Off (To turn OFF the Relay)

Touch on “**OK**” key” will confirm the setting and take back to the previous screen.

Touch on “**BACK**” key” will take back to the previous screen.

⚠ Caution:If the relay is selected in Manual mode, it would not work in the automatic mode and hence relay would not take any action if fault condition occurs (refer Section 7 “Relay Tripping Functionality”). Manual mode can be used for maintenance purpose.

3.2.4.3 Disable Mode

The relay can be disabled in which case it turns OFF. This can be done in the Relay Control menu (Section 3.2.4).



The user can select the option of Disable to disable the relay.

Touch on “**OK**” key” will confirm the setting and take back to the previous screen.

Touch on “**BACK**” key” will take back to the previous screen without any changes.

⚠ Caution:If the relay is selected in Disable mode, it would not function in the automatic mode and hence relay would not take any action if fault condition occurs (refer Section 7 “Relay Tripping Functionality”).

3.2.5 Reset Parameter Selection:-

3.2.5.1 Resetting Parameter

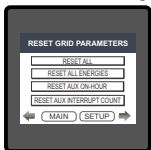

These screens allow the users to reset the following parameters: Energies, Auxiliary On-Hour, Auxiliary Interrupt or all of these.

User needs to touch on the specific parameter to be reset.



Touching on any parameter will display the confirmation dialog, now a touch on " YES "key" will confirm the resetting of that particular Parameter.

Touching on " NO "key" will move back to Reset parameters menu. For example resetting All Energies will display a confirmation dialog as shown in the screen beside. User can reset other parameters in similar manner

3.2.6 Brightness & Contrast



The brightness & contrast of the TFT LCD screen can be varied by the user by sliding the sliders. Touching the " OK " key" will confirm the current brightness contrast setting.

Touching the DEFAULT key will set brightness and contrast as per factory settings. Touching the BACK key will move back to the setup menu without making any changes.

3.2.7 RGB Color Code



This screen allows user to set the values of Red, Green and Blue components of colors used to display the parameters of all three phases. Different colors can be assigned to each phase using combination of Red, Green and Blue component values. L1,L2,L3 will be set to the assigned color.



To set these values, touch the corresponding rectangular section, 0 to 9 digit input keypad will appear. After entering the value using this keypad, user can confirm this value with a simple touch on “ENTER” key. “BACK” key” is used to go back to previous screen.

The allowable range for these values is 0 to 255. If a value outside this range is entered, it will display “VALID RANGE IS : 0 TO 255”.

NOTE : Colors similar to background are not recommended.

Standard color combinations

| COLOR | R | G | B |
|------------|-----|-----|-----|
| Black | 0 | 0 | 0 |
| Blue | 0 | 0 | 255 |
| Brass | 181 | 166 | 66 |
| Bronze | 204 | 128 | 51 |
| Brown | 166 | 41 | 41 |
| Copper | 184 | 115 | 51 |
| Dark Blue | 0 | 0 | 140 |
| Dark Brown | 102 | 66 | 33 |
| Dark Green | 0 | 51 | 33 |

| COLOR | R | G | B |
|-------------|-----|-----|-----|
| Dark Pink | 232 | 84 | 128 |
| Dark Purple | 48 | 26 | 51 |
| Dark Red | 140 | 0 | 0 |
| Dark Violet | 148 | 0 | 212 |
| Dark Yellow | 156 | 135 | 13 |
| Gold | 212 | 176 | 56 |
| Gray | 128 | 128 | 128 |
| Green | 0 | 255 | 0 |
| Indigo | 74 | 0 | 130 |

| COLOR | R | G | B |
|------------|-----|-----|-----|
| Light Blue | 173 | 217 | 230 |
| Maroon | 176 | 48 | 97 |
| Pink | 255 | 191 | 204 |
| Purple | 161 | 33 | 240 |
| Red | 255 | 0 | 0 |
| Silver | 191 | 191 | 191 |
| Violet | 143 | 0 | 255 |
| White | 255 | 255 | 255 |
| Yellow | 255 | 255 | 0 |

3.2.8 Factory Reset



Touching the "FACTORY RESET" option of Section 3.2 will provide a confirmation dialog.

Touching " " allows the user to erase all data from the meter and set all setup parameters to their default values while touching " " will make no change.

4 Touch screen calibration

This instrument is able to perform calibration to ensure the proper operation of the units touch screen functionalities. The calibration procedure will correct the problem of out of tolerance touch screen malfunction. Note that errors corrected by this calibration procedure are specific only to touch screen operation.



For starting touch screen calibration, touch the screen anywhere for 1 sec at system reset. After that touch screen calibration will start & the message shown besides will be displayed. Touch the screen to continue.

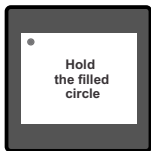

Follow the instructions displayed. Press & hold the center of the filled red circle for at least 2 seconds. Release when message for release is being displayed. For accurate results try to touch the center of the filled circle.



Repeat the same procedure for the remaining 3 corner circles.

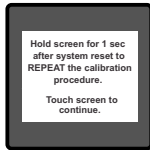

After successful calibration, the message shown besides would be displayed. Touch the screen to continue.

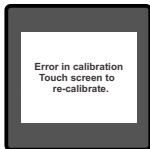

If the touch screen was not calibrated properly, "Error in calibration" message would be shown & the user will be asked to recalibrate the touch screen. In such case the meter will retain the previously stored touch - screen calibration values unless a successful calibration is being performed.

5. Phase Sequence Indication screen

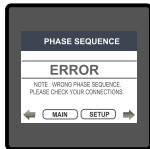

Meter shows phase rotation error if the phase sequence R-Y-B (L1-L2-L3) is not maintained. This screen indicates that Phase sequence is incorrect. User must check this screen in order to get correct readings when meter is connected.

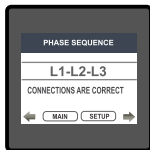

Correct Phase sequence

This screen indicates the phase sequence connected to meter is correct. If phase sequence is wrong this screen is useful to get correct phase sequence by interchanging connection & verifying it with screen.

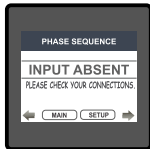

This screen indicates that either of the phases or all three phases (Voltages) are absent.

6. Measurement Screens

6.1 Main Screen

The Main screen consists of three icons/ buttons : Grid / Generator, Load & Solar touching which takes to the parameters of the corresponding menu. The direction of movement of lines connecting the icons indicate the direction of power flow.

When Generator is not sensed at Gensense input of addon card :

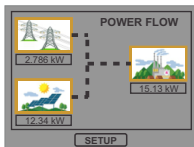

Load consuming both Solar and Grid power.

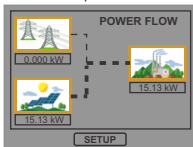

Load consuming only Solar power.

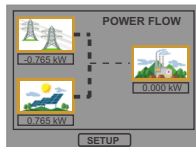

Total Solar power being exported to grid.

When Generator is sensed at Gensense input of addon card :

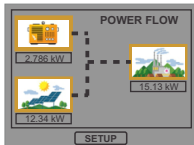

Load consuming both Solar and Generator power.

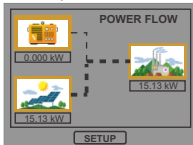

Load consuming only Solar power.

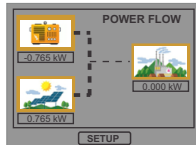

Total Solar power being exported to generator.

6.2 Grid / Generator Menu

This menu includes following Parameters: Power, Active Energy, voltage, current, frequency and auxiliary parameters like phasor diagram, aux. on hour, THD, etc.

6.3 Load Menu

It contains graphical view of power distribution at the load. The contribution of solar & grid (or generator) power is shown in the pie chart along with corresponding percentage.

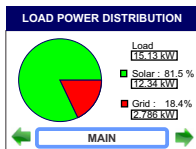

6.4 Solar Menu

The Solar Menu contains all the information the user needs to know about the PV (Photovoltaic) plant, in tabular as well as graphical form.

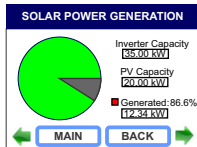

Solar power generation compared to the total PV (Panel) Capacity or Inverter Capacity.

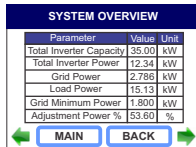

The total Inverter Capacity, Total Inverter Power, Grid / Gen. Power, Load Power, Grid / Gen. Min Power and Adjustment Power % for all the inverters combined.

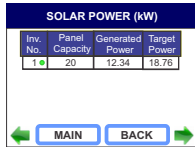

The connectivity, panel capacity, generated power and target power (Adjustment Power as % of Inverter Capacity) for individual inverter.

| SOLAR CAPACITIES (kW) | | |
|-----------------------|-------------------|----------------|
| Inv. No. | Inverter Capacity | Panel Capacity |
| 1 | 35.00 | 20 |

← MAIN BACK →

Comparison of Inverter Capacity and Panel Capacity for individual inverter.

| CONNECTION STATUS | | |
|-------------------|---------------|-----------------|
| Inv. No. | Inverter Type | Inverter Status |
| 1 | RADIUS | Active |

← MAIN BACK →

Inverter Type (Make) and corresponding connection status for individual inverter.

6.5 Indications on main screen :

Fault : If the meter relay is selected in Automatic mode (Section 3.2.4) and if the fault condition occurs (Section 7) the same is indicated on the main screen.

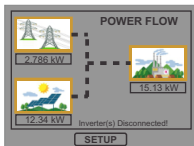

Inverter disconnection
Fault when Grid is connected to inverter.

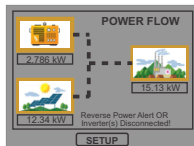

Inverter disconnection
Fault when Generator is connected to inverter.

7. Relay Tripping Functionality :

This instrument is provided with 1 relay for disconnecting the inverter(s) from the Grid / Generator if fault condition occurs. The fault condition is different for Grid and Generator.

Fault condition when Grid is connected :

Consider that the Grid is connected to the Load, i.e., Generator is not sensed at the add-on card.

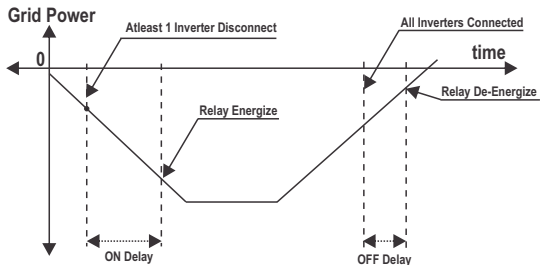

Figure 7.1: Waveform of Relay functioning for fault condition in Energized Configuration

The fault condition occurs when atleast one of the selected inverters (see Section 3.2.2.2.5) gets disconnected.

If the fault condition occurs for a time greater than the ON Delay (see Section 3.2.4.1.1.1) and if Energized configuration (see Section 3.2.4.1.1.3) is selected for the relay, the relay would Energize.

Once all the inverters get connected for a time greater than the OFF Delay (see Section 3.2.4.1.1.2), the relay would de-Energize.

Fault condition when Generator is connected :

Consider that the Generator is connected to the Load, i.e., Generator is sensed at the add-on card.

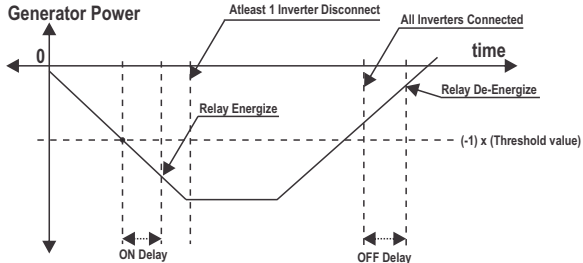

Figure 7.2: Waveform of Relay functioning for fault condition in Energized Configuration

The fault condition occurs when atleast one of the selected inverters (see Section 3.2.2.2.5) gets disconnected or the reverse power with magnitude higher than the Relay Threshold (see Section 3.2.4.1.2.1) gets pumped to the Generator.

If the fault condition occurs for a time greater than the ON Delay (see Section 3.2.4.1.2.2) and if Energized configuration (see Section 3.2.4.1.2.4) is selected for the relay, the relay would Energize.

Once all the inverters regain communication and the reverse power doesn't get pumped to the Generator for a time greater than the OFF Delay (see Section 3.2.4.1.2.3), the relay would De-Energize.

Relay functioning for De-Energized configuration :

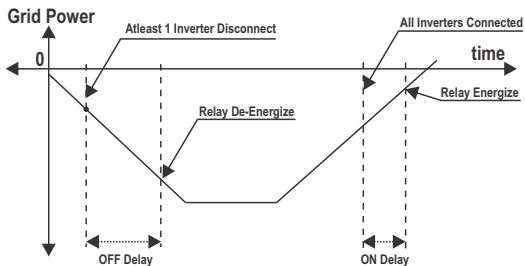

Figure 7.3: Waveform of Relay functioning for fault condition in De-Energized Configuration

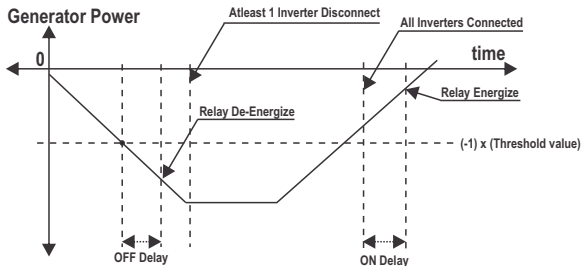

Figure 7.4: Waveform of Relay functioning for fault condition in De-Energized Configuration

8. Phasor Diagram :

Quadrant 1: 0° to 90°

Quadrant 3: 180° to 270°

Quadrant 2: 90° to 180°

Quadrant 4: 270° to 360°

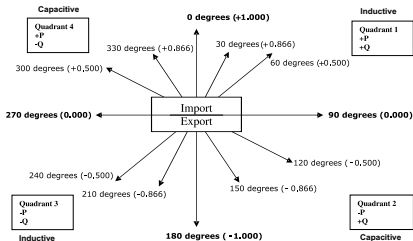

| Connections | Quadrant | Sign of Active Power (P) | Sign of Reactive Power (Q) | Sign of Power Factor (PF) | Inductive / Capacitive |
|-------------|----------|----------------------------|------------------------------|-----------------------------|------------------------|
| Import | 1 | + P | + Q | + | L |
| Import | 4 | + P | - Q | + | C |
| Export | 2 | - P | + Q | - | C |
| Export | 3 | - P | - Q | - | L |

Inductive means Current lags Voltage
When the Instrument displays Active power (P) with "+" (positive sign), the connection is "**Import**".

Capacitive means Current leads Voltage
When the Instrument displays Active power (P) with "-" (negative sign), the connection is "**Export**".

9. Installation

Mounting is by four side clamps, slide the side clamps through side slot till side clamp gets firmly locked in a groove (Refer fig.) Consideration should be given to the space required behind the instrument to allow for bends in the connection cables. As the front of the enclosure conforms to IP54 it is protected from water spray from all directions, additional protection to the panel may be obtained by the use of an optional panel gasket.

The terminals at the rear of the product should be protected from liquids.

The instrument should be mounted in a reasonably stable ambient temperature and where the operating temperature is within the range -20 to 70°C .

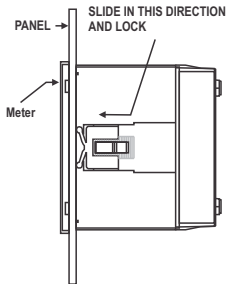

Vibration should be kept to a minimum and the product should not be mounted where it will be subjected to excessive direct sunlight.

Caution

1. **In the interest of safety and functionality this product must be installed by a qualified engineer, abiding by any local regulations.**
2. **Voltages dangerous to human life are present at some of the terminal connections of this unit. Ensure that all supplies are de-energised before attempting any connection or disconnection.**
3. **These products do not have internal fuses therefore external fuses must be used to ensure safety under fault conditions.**

9.1 EMC Installation Requirements

This product has been designed to meet the certification of the EU directives when installed to a good code of practice for EMC in industrial environments, e.g.

1. Screened output and low signal input leads or have provision for fitting RF suppression components, such as ferrite absorbers, line filters etc., in the event that RF fields cause problems.

Note: It is good practice to install sensitive electronic instruments that are performing critical functions, in EMC enclosures that protect against electrical interference which could cause a disturbance in function.

2. Avoid routing leads alongside cables and products that are, or could be, a source of interference.
3. To protect the product against permanent damage, surge transients must be limited to 2kV pk. It is good EMC practice to suppress differential surges to 2kV at the source. The unit has been designed to automatically recover in the event of a high level of transients. In extreme circumstances it may be necessary to temporarily disconnect the auxiliary supply for a period of greater than 5 seconds to restore correct operation. The Current inputs of these products are designed for connection in to systems via Current Transformers only, where one side is grounded.
4. ESD precautions must be taken at all times when handling this product.

9.2 Case Dimension and Panel Cut Out

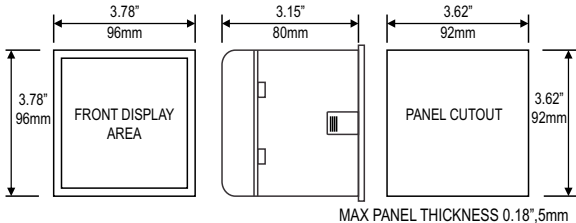

9.3 Wiring

Input connections are made directly to screw-type terminals with indirect wire pressure. Numbering is clearly marked in the plastic moulding. Choice of cable should meet local regulations. Terminal for both Current and Voltage inputs will accept upto 3mm x 2 diameter cables.

Note : It is recommended to use wire with lug for connection with meter.

9.4 Auxiliary Supply

The instrument should ideally be powered from a dedicated supply, however it may be powered from the signal source, provided the source remains within the limits of the chosen auxiliary voltage.

9.5 Fusing

It is recommended that all voltage lines are fitted with 1 amp HRC fuses.

9.6 Earth/Ground Connections

For safety reasons, CT secondary connections should be grounded in accordance with local regulations.

10. Connection Block Diagram

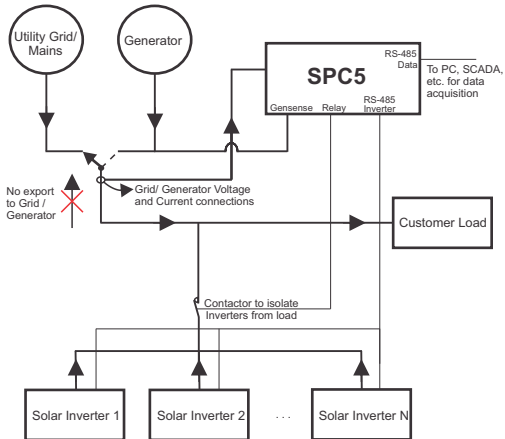

11. Wiring Diagram

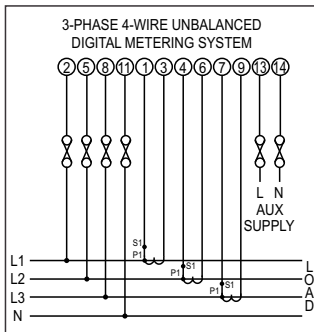

12. Specification

| | |
|--|---|
| System Type | 3P4W (Fixed) |
| Inverters | |
| Maximum Inverters | 20 |
| Compatibility with | Radius PVSA |
| Correction Time | 1 min. approx. |
| Overall time taken to prevent the reverse power flow considering the inverter response time. | |
| Display | |
| TFT LCD | 3.5" Graphical LCD, resolution 320x240 pixels |
| Update | Approx. 1 seconds |
| Controls | |
| User Interface | Resistive Touch Screen |
| Inputs | |
| Nominal Input Voltage (AC RMS) | 100VLL to 600VLL programmable on site. (57.7VLN to 346.4VLN) |
| System PT Primary Values | 100VLL to 692.8 kVLL, programmable on site |
| System PT Secondary Values | 100VLL to 600VLL programmable on site. (57.7VLN to 346.4VLN) |
| Max continuous input voltage | 120% of Nominal Value |
| Nominal input voltage burden | <0.3 VA approx. per Phase (at nominal 240V) |
| Nominal Input Current | 1A/5A |
| max continuous input current | 120% of Nominal value |
| Nominal input current burden (Inbuilt CT) | <0.3 VA approx. per phase |
| System CT primary values | Std. Values 1 to 9999A (1 or 5 Amp secondary) |
| System CT secondary values | 1A / 5A, programmable on site |
| Overload Indication | "-OL-" >121% of Nominal value (for voltage and current) |
| Generator Sense | |
| AC Voltage | 20 to 300VAC |
| DC Voltage | 10 to 60VDC |

Overload withstand

| | |
|---------------|--|
| Voltage input | 2 x Rated Value (1s application at 10s intervals) repeated 10 times |
| Current input | 2 x nominal Value (1s application at 5min intervals) repeated 5 times |

Auxiliary Supply

| | |
|------------------------------------|--------------------------------|
| External Higher Aux. | 100V to 550V AC/DC |
| External Higher Aux. Nominal Value | 230V AC/DC 50/60 Hz for AC Aux |
| Aux Frequency Range | 45 to 65 Hz |
| VA Burden With Addon card | < 8 VA approx. (at nominal) |

Operating Measuring Ranges

| | |
|---------------------------|--|
| Voltage | 20 ... 120 % of nominal Value |
| Current | 1....120% of nominal value |
| Starting Current | as per IEC 62053-22 (0.2S) |
| Frequency | 45 to 65 Hz |
| Total Harmonic Distortion | 50% upto 15th harmonic 10% upto 31st harmonic |

Accuracy

| | |
|---------------------------------|---------------------------------|
| Voltage | ± 0.2 % of range |
| Current | ± 0.2 % of range |
| Frequency | 0.15% of mid frequency |
| Active Power (Grid/ Generator) | ± 0.2 % of range |
| Active Energy (Grid/ Generator) | as per IEC 62053-22 (0.2S) |
| Active Power (Inverter) | as per the accuracy of inverter |
| Active Power (Load) | as per the accuracy of inverter |
| Total Harmonic Distortion | ± 3 % |
| Neutral Current | ± 4 % of range |

Reference conditions for Accuracy :

| | |
|----------------------------|--|
| Reference temperature | 23 °C ± 2 °C |
| Input frequency | 50 or 60Hz ± 2% |
| Input waveform | Sinusoidal (distortion factor 0.005) |
| Auxiliary supply voltage | Rated Value ± 1 % |
| Auxiliary supply frequency | Rated Value ± 1 % |
| Voltage Range | 50... 100% of Nominal Value. 60... 100% of Nominal Value for THD. |
| Current Range | 10... 100% of Nominal Value. 20... 100% of Nominal Value for THD. |
| Power | cosφ / sinφ = 1 For Power & Energy 10... 100% of Nominal Current & 50... 100% of Nominal Voltage. |

Nominal range of use of influence quantities for measurands

| | |
|---|---|
| Voltage | 50 .. 120 % of Rated Value |
| Current | 10 .. 120 % of Rated Value |
| Input frequency | Rated Value ± 10 % |
| Temperature | 0 to 50 °C |
| Auxiliary supply voltage | Rated Value ± 10 % |
| Auxiliary supply frequency | Rated Value ± 10 % |
| Temperature Coefficient (For Rated value range of use 0... 50°C) | 0.025% / °C for Voltage (50..120% of Rated Value) 0.05% / °C for Current (10..120% of Rated Value) |
| Error change due to variation of an influence quantity | 2 * Error allowed for the reference condition applied in the test. |

Standards

| | |
|---------------------|--|
| EMC Immunity | IEC 61326 10V/m min-Level 3 industrial low level electromagnetic radiation environment IEC 61000-4-3. |
| Safety | IEC 61010-1 , Year 2001 |
| IP for water & dust | IEC 60529 |

Isolation

| | |
|--|--|
| Dielectric voltage withstand test between circuits and accessible surfaces | 2.2 kV RMS 50 Hz for 1 minute between all electrical circuits |
|--|--|

Environmental

| | |
|--------------------------|-------------------------------|
| Operating temperature | -20 to +70 ^o C |
| Storage temperature | -25 to +75 ^o C |
| Relative humidity | 0 .. 90 % RH |
| Warm up time | 3 minute (minimum) |
| Shock | 15g in 3 planes |
| Vibration | 10 .. 55 Hz, 0.15mm amplitude |
| Enclosure (front only) | IP 54 as per IEC 60529 |

Enclosure

| | |
|-----------|---|
| Style | 96mm x 96mm DIN Quadratic |
| Material | Polycarbonate Housing , |
| Terminals | Self extinguish & non dripping as per UL 94 V-0 Screw-type terminals |
| Depth | < 80 mm |
| Weight | 0.620 kg Approx. |

Relay Output Options:

| | |
|-------------------------------|-------------------------------|
| Port | 1 NO + 1 NC |
| Switching Voltage and Current | 250VAC, 5A AC 30VDC, 5A DC |

Modbus Options:

Dual Modbus (RS485 Data & RS485 Inverters)

| | |
|-----------|--|
| Protocol | ModBus (RS 485) |
| Baud Rate | 4.8k, 9.6k, 19.2k, 38.4k, 57.6k (Programmable) |
| Parity | Odd or Even, with 1 stop bit, Or None with 1 or 2 stop bits |

13. Connection for Dual Modbus Addon Card (rear view of the instrument) :

Model With Gensense:

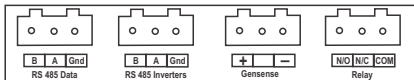

The Information contained in these installation instructions is for use only by installers trained to make electrical power installations and is intended to describe the correct method of installation for this product.

It is the user's responsibility to determine the suitability of the installation method in the user's field conditions.



LUMEL S.A.

ul. Słubicka 4, 65-127 Zielona Góra, Poland
tel.: +48 68 45 75 100, fax +48 68 45 75 508
www.lumel.com.pl

Technical support:

tel.: (+48 68) 45 75 143, 45 75 141, 45 75 144, 45 75 140
e-mail: export@lumel.com.pl

Export department:

tel.: (+48 68) 45 75 130, 45 75 131, 45 75 132
e-mail: export@lumel.com.pl

Calibration & Attestation:

e-mail: laboratorium@lumel.com.pl