



5 in 1 DIGITAL MULTIMETER

**VA19**



**Users Manual**



## CONTENTS

1. SAFETY INFORMATION.....	3
2. DESCRIPTION.....	8
3. SPECIFICATIONS.....	11
4. OPERATING INSTRUCTION.....	20
5. MAINTENANCE.....	34
6. ACCESSORIES.....	36

# 1. SAFETY INFORMATION

 **WARNING**

**To ensure safe operation, and in order to exploit to the full functionality of the meter, please follow the directions in this section carefully.**

This multimeter has been designed according to IEC61010 concerning electronic measuring instruments with an overvoltage category CAT $\text{III}$  600V and pollution 2.

With proper use and care, the digital multimeter will give you years of satisfactory service.

Follow all safety and operating instructions to ensure that the meter is used safely and is kept in good operating condition.

## 1.1 PRELIMINARY

**1.1.1 When using the meter, the user must observe all normal safety rules concerning:**

- Protection against the danger of electrical attack
- Protection of the meter against misuse

1.1.2 When the meter is delivered, check if it has been damaged in transit.

- 1.1.3 When harsh preservation or shipping conditions caused, inspect and confirm this meter without delay.
- 1.1.4 Test leads must be in good condition. Before using verify that the insulation on test leads is not damaged and/or the leads' wire is not exposed.
- 1.1.5 Full compliance with safety standards can be guaranteed only if used with test leads supplied. If necessary, they must be replaced with the same model or the same class.

## **1.2 DURING USE**

- 1.2.1 Before using, you must select the right input jack, function and range.
- 1.2.2 Never exceed the protection limit values indicated in specifications for each range of measurement.
- 1.2.3 When the meter is linked to a measurement circuit, do not touch unused terminals.
- 1.2.4 Do not measure voltage if the voltage on the terminals exceeds 600V above earth ground.
- 1.2.5 At the manual range, when the value scale to be measured is unknown beforehand, set the range selector at the highest position.
- 1.2.6 Always be careful when working with voltages above 60V DC or 30V AC rms, keep fingers behind the probe barriers while measuring.
- 1.2.7 Never connect the meter with any voltage source while

the function switch is in the current, resistance, capacitance, diode, continuity, temperature, humidity, sound level or illuminance range, otherwise it will damage the meter.

- 1.2.8 Before stir the transform switch to change functions, disconnect test leads from the circuit under test.
- 1.2.9 When carrying out measurements on TV or switching power circuits always remember that there may be high amplitude voltages pulses at test points, which can damage the meter.
- 1.2.10 Never measure any of resistance, capacitance, diode or continuity measurements on live circuits.
- 1.2.11 Never perform capacitance measurements unless the capacitor to be measured has been discharged fully.
- 1.2.12 Never use the meter under the condition of the explosive air, steam or dirt.
- 1.2.13 If any faults or abnormalities are observed, the meter can not be used any more and it has to be checked out.
- 1.2.14 Never use the meter unless the rear case is in place and fastened fully.
- 1.2.15 Please do not store or use meter in areas exposed to direct sunlight, high temperature, humidity or condensation.

## 1.3 SYMBOLS

 Important safety information, refer to the operating manual.

 Dangerous voltage may be presence.

 Double insulation (Protection class II) .

CAT III Overvoltage (Installation) category III, Pollution Degree 2 per IEC61010-1 refers to the level of

Impulse

Withstand Voltage protection provided.

 Conforms to European Union Directive

 Earth ground

 Fuse

 Low Battery

~ AC (alternating current)

≡ DC (direct current)

••• Continuity Buzzer

≈ AC or DC (alternating current or direct current)

## 1.4 MAINTENANCE

1.4.1 Please do not attempt to adjust or repair the meter by removing the rear case while voltage is being applied. A technician who fully understands danger involved should only carry out such actions.

1.4.2 Before opening the case of the meter, always disconnect test leads from all sources of electric

current.

- 1.4.3 To avoid the wrong reading causing electricity attack, when the meter displays “”, you must change the battery.
- 1.4.4 For continue protection against fire, replace fuse only with the specified voltage and current ratings: F 500mA/600V 10A/600V(quick acting).
- 1.4.5 Do not use abrasives or solvents on the meter, use a damp cloth and mild detergent only.
- 1.4.6 ALWAYS set the power switch to the OFF position when the meter is not in use.
- 1.4.7 If the meter is to be stored for a long period of time, the batteries should be removed to prevent damage to the unit.

## 2. DESCRIPTION



- The 5 in 1 digital multi-tester has been designed to combine the functions of Sound Level Meter, Light Meter, Humidity Meter, Temperature Meter and Digital Multimeter.
- The Sound Level function can be used to measure noise in factories, schools, offices, airports, home, etc., checking acoustics of studios, auditoriums and hi-fi installations.
- The Light function is used to measure illuminance in the field. It is fully cosine corrected for the angular incidence of light. The light sensitive component used in the meter is a very Stable, long life silicon diode.
- The Humidity/Temperature is for use a humidity semiconductor sensor and K type thermocouple.
- The digital Multimeter performs AC/DC Voltage, AC/DC Current, Resistance , Frequency, Duty, Capacitance measurement and Continuity, Diode test.
- This meter is a portable professional measuring instrument with large LCD and back light easily reading. Single operation of a range switch makes measurement convenient. Overload protection and low battery indication are provided. It is an ideal multi-function Instrument with scores of practical applications for professional, workshop, school, hobby and home use.

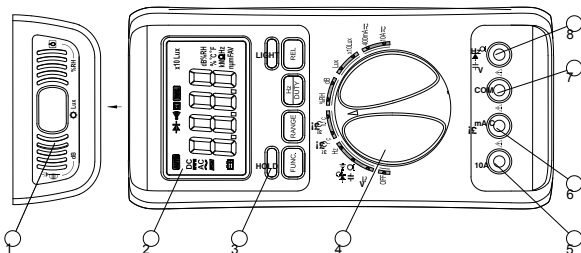

- When using, it can show ranges engineering unit enunciators measuring results.
- This meter has function of auto range and manual range.
- This meter has function of auto power off.
- This meter has function of data hold.
- This meter has function of relative measuring.

## 2.1 NAMES OF COMPONENTS





- 1 Light, Sound and Humidity Sensitive Component
- 2 LCD Display
- 3 Function Transform Button
- 4 Function Rotary Switch
- 5 10A Input Jack
- 6 mA/°C Input Jack
- 7 COM Input Jack
- 8 V,  $\Omega$ , Hz,   Input Jack

## 2.2 SWITCH, BUTTONS AND INPUT JACK ELUCIDATION

- HOLD Button: This Button is used to the switch of data hold.
- FUNC Button: This button is used to transform function.
- RANGE Button: This button is used to transform Auto range or manual range.
- Hz% Button: This button is used to the transformation of Hz or Duty measuring.
- REL Button: This button is used to the transformation of relative measuring.
- LIGHT Button: This button is used to the switch of back light.
- Transform Switch: This switch is used to select functions and desired ranges.
- OFF – switch: This switch is used to turn off the power.
- 10A Input Jack: Input terminal for current 0 ~ 10A.
- mA/°C Input Jack: Input terminal for current 0 ~ 400mA,

centigrade temperature.

- V、 $\Omega$ 、Hz、、 Input Jack  
Input terminal for voltage, resistance, frequency, duty, capacitance, diode, continuity.
- COM Input Jack  
Common terminal for current, voltage, resistance, frequency, duty, capacitance, diode and continuity measurement.
- Humidity Semiconductor Sensor: This sensor is used to measure humidity.

## 3. SPECIFICATIONS

Accuracy is specified for a period of year after calibration and at 18 °C to 28 °C (64 °F to 82 °F) with relative humidity to 75%.

### 3.1 GENERAL SPECIFICATIONS

- 3.1.1 It includes 14 function with 39 ranges.
- 3.1.2 Auto ranges and manual range.
- 3.1.3 Overrange protection for all ranges.
- 3.1.4 Max. Voltage Between Terminals And Earth Ground:  
600V DC or rms AC
- 3.1.5 Operating Altitude: 2000 meters (7000 ft.) maximum
- 3.1.6 Display: LCD
- 3.1.7 Max. Show Value: 3999 counts max
- 3.1.8 Polarity Indication: '-' indicates negative polarity.

- 3.1.9 Overrange Indication: Display '0L' or '-0L'
- 3.1.10 Sampling Time: approx. 0.4 second
- 3.1.11 Unit showing: showing of function and electrical capacity.
- 3.1.12 Auto power off time: 15 min.
- 3.1.13 Fuse Protection: F 500mA/600V 10A/600V(quick acting).
- 3.1.14 Power Supply: 9V battery, NEDA 1604 or 6F22
- 3.1.15 Low Battery Indication: '  ' displayed
- 3.1.16 Temperature Factor:  $< 0.1 \times \text{Accuracy} / ^\circ\text{C}$
- 3.1.17 Operating Temperature:  $0^\circ\text{C}$  to  $40^\circ\text{C}$  ( $32^\circ\text{F}$  to  $104^\circ\text{F}$ )
- 3.1.18 Storage Temperature:  $-10^\circ\text{C}$  to  $50^\circ\text{C}$  ( $10^\circ\text{F}$  to  $122^\circ\text{F}$ )
- 3.1.19 Dimension: 178×85×40mm
- 3.1.20 Weight: approximate 320g (including battery)

## 3.2 ELECTRICAL SPECIFICATIONS

Circumstance Temperature:  $23^\circ\text{C}$ ; Relative Humidity:  $< 70\%$

### 3.2.1 DC Voltage

Range	Resolution	Accuracy
400mV	0.1mV	$\pm (0.8\% \text{ of rdg} + 5\text{digits})$
4V	1mV	
40V	10mV	
400V	100mV	
600V	1V	$\pm (1.0\% \text{ of rdg} + 5\text{digits})$

- Input Impedance:  $10\text{M}\Omega$

- Overload Protection: 400mV range: 250V DC or rms AC,

4V-600V ranges: 600V DC or 600V rms AC.

- Max. Input Voltage: 600V DC or rms AC

**NOTE:**

At the little voltage range, the meter will show unsteady reading when test leads haven't reach the circuit, it's normal because the meter is very sensitivity. When test leads touch the circuit, you can get the true reading.

**3.2.2 AC Voltage**

Range	Resolution	Accuracy
4V	1mV	± (1% of rdg + 6digits)
40V	10mV	
400V	100mV	
600V	1V	± (1.5% of rdg + 6digits)

- Input Impedance: 10MΩ

- Overload Protection: 400mV range: 250V DC or rms AC,  
4V-700V ranges: 600V DC or 600V rms AC.

- Max. Input Voltage: 600V DC or rms AC

- Frequency Range: 40 to 400Hz

- Response: Average, calibrated in rms of sine wave

**NOTE:**

At the little voltage range, the meter will show unsteady reading when test leads haven't reach the circuit, it's normal because the meter is very sensitivity. When test leads touch the circuit, you can get the true reading.

### 3.2.3 DC Current

Range	Resolution	Accuracy
40mA	10 $\mu$ A	$\pm$ (1.2% of rdg + 5 digits)
400mA	100 $\mu$ A	$\pm$ (1.2% of rdg + 5 digits)
10A	10mA	$\pm$ (2.5% of rdg + 10 digits)

- Overload Protection: mA ranges: F 500mA/600V fuse (quick acting), 10A range: 10A/600V fuse.

- Max. Input Current: mA Jack: 400mA, 10A Jack: 10A

-Voltage Drop: mA ranges: 1mV/1mA, 10A range: 10mV/1A

### 3.2.4 AC Current

Range	Resolution	Accuracy
40mA	10 $\mu$ A	$\pm$ (1.5% of rdg + 8 digits)
400mA	100 $\mu$ A	$\pm$ (1.5% of rdg + 8 digits)
10A	10mA	$\pm$ (3.0% of rdg + 10 digits)

-Overload Protection: mA ranges: F 500mA/600V fuse (quick acting), 10A range: 10A/600V fuse.

- Max. Input Current: mA Jack: 400mA, 10A Jack: 10A

-Voltage Drop: mA ranges: 5mV/1mA, 10A range: 10mV/1A

- Frequency Range: 40 to 400Hz

- Response: Average, calibrated in rms of sine wave

### 3.2.5 Resistance

Range	Resolution	Accuracy
400 $\Omega$	0.1 $\Omega$	$\pm$ (1.2% of rdg + 5digits)
4k $\Omega$	1 $\Omega$	

40k $\Omega$	10 $\Omega$	
400k $\Omega$	100 $\Omega$	
4M $\Omega$	1k $\Omega$	
40M $\Omega$	10k $\Omega$	

- Open Circuit Voltage: 0.25V

- Overload Protection: 250V DC or rms AC

### 3.2.6 Capacitance

Range	Resolution	Accuracy
4nF	1pF	$\pm$ (4.0% of rdg + 30 digits)
40nF	10pF	$\pm$ (4.0% of rdg + 10 digits)
400nF	0.1nF	
4 $\mu$ F	1nF	
40 $\mu$ F	10nF	
100 $\mu$ F	100nF	$\pm$ (8.0% of rdg + 30 digits)

- Overload Protection: 250V DC or rms AC

### 3.2.7 Frequency

Range	Resolution	Accuracy
9.999Hz	0.001Hz	$\pm$ (2.0% of rdg + 6 digits)
99.99Hz	0.01Hz	$\pm$ (1.5% of rdg + 6 digits)
999.9Hz	0.1Hz	
9.999kHz	1Hz	
99.99kHz	10Hz	
199.99kHz	100Hz	$\pm$ (2.0% of rdg + 6 digits)
>200kHz		Take it only as referance

- By Hz Range:

Measurement Range: 0 ~ 200kHz

Input Voltage Range: 0.5V – 10V rms AC (Input voltage must be enlarged with increasing frequency under measurement)

Overload Protection: 250V DC or rms AC

- By V Range:

Measurement Range: 0 ~ 40kHz

Input Voltage Range: 0.5V – 600V rms AC (Input voltage must be enlarged with increasing frequency under measurement)

Input Impedance: 10M $\Omega$

Max. Input Voltage: 600V DC or rms AC

- By mA Range:

Measurement Range: 0 ~ 40kHz

Input Current Range: 100mA – 400mA rms AC (Input Current must be enlarged with increasing frequency under measurement)

Max. Input Current: 400mA DC or rms AC

Overload Protection: F 500mA/600V fuse (quick acting).

**NOTE:**

When measuring frequency, the range by Hz range is larger than by Hz of Voltage range or current range, but the value measured beyond the range is just for reference.

**3.2.8 Duty Cycle**

Range	Resolution	Accuracy
0.1 - 99.9%	0.1%	$\pm 5.0\%$

- By Hz Range:

Frequency Response: 0 ~ 200kHz



Input Voltage Range: 0.5V – 10V rms AC (Input voltage must be enlarged with increasing frequency under measurement)

Overload Protection: 250V DC or rms AC

- By V range:

Frequency Response: 0 ~ 40kHz

Input Voltage Range: 0.5V – 600V rms AC (Input voltage must be enlarged with increasing frequency under measurement)

Input Impedance: 10M $\Omega$

Max. Input Voltage: 600V DC or rms AC

- By mA range:

Frequency Response: 0 ~ 40kHz

Input Current Range: 100mA – 400mA rms AC (Input current must be enlarged with increasing frequency under measurement)

Max. Input Current: 400mA DC or rms AC

Overload Protection: F 500mA/600V fuse (quick acting).

**NOTE:**

When measuring frequency, the range by DUTY of Hz range is larger than by DUTY of Voltage range or current range.

### 3.2.9 Temperature

Range	Resolution	Accuracy
-20 °C to 0 °C 0 °C to 20 °C 20 °C to 400 °C	0.1 °C	± (5.0% of rdg + 5digits) ± (3.0% of rdg + 5digits) ± (2.0% of rdg + 5digits)
-20 °C to 0 °C 0 °C to 400 °C 400 °C to 1000 °C	1 °C	± (5.0% of rdg + 5digits) ± (3.0% of rdg + 5digits) ± (2.0% of rdg + 5digits)

- Overload Protection: F 500mA/600V fuse (quick acting).

### 3.2.10 Humidity (RH)

Range	Resolution	Accuracy
30 - 90%	0.1%	±10.0%RH

- Operating Temperature: 0 °C to 40 °C

- Response -Time:

45% RH→90% RH ≤10 min.

90% RH→45% RH ≤15 min.

### 3.2.11 Sound Level (dB)

Range	Resolution	Accuracy
45-100dB	0.1 dB	±8.0dB at 94dB, 1kHz sine wave

- Typical Instrument Frequency Range: 100 ~ 10000Hz

### 3.2.12 Illuminance (Lux)

Range	Resolution	Accuracy
Lux (4000)	1 Lux	(8.0% of rdg + 50digits) at color temp. 2850K calibrated to standard incandescent lamp at color temperature 2856 k
×10Lu x(40000)	10Lux	

- Repeat ability:  $\pm 2\%$ .

### 3.2.13 Diode

Range	Resolution	Function
	1mV	Display :read approximate forward voltage of diode

- Forward DC Current approximate 1mA    Reversed DC Voltage approximate 1.5V

- Overload Protection: 250V DC or rms AC

### 3.2.14 Continuity

Range	Function
•  )	Built-in buzzer will sound, if resistance is lower than $60\Omega$

- Open circuit voltage approximate: 0.5V

- Overload Protection: 250V DC or rms AC

## **4. OPERATING INSTRUCTION**

### **4.1 DATA HOLD**

If you need data hold when measuring, you can put on "HOLD", it will hold the reading; if you put the button again, data hold will not continue.

### **4.2 FUNCTION TRANSFORM**

Put down the "FUNC" when measuring the current and voltage. Meter will be transformed between DC and AC range. Put "FUNC" when measuring the resistance, capacitance, diode and continuity, meter will transform among them.

### **4.3 RANGE TRANSFORM**

The auto range is used when measuring the current, voltage and resistance. Put down the "RANGE" if the manual range is needed. Each time you put down, range will go upward; the minimum range is transformed if "RANGE" is put down at the maximum range. If the "RANGE" is put down more than two seconds, auto range is used again

### **4.4 HZ/DUTY TRANSFORM**

- Put down the "Hz%." when measuring the Hz range. Meter will be transformed at DUTY range. Press the "Hz%" again, meter will recover the Hz range.
- When measuring at the voltage range and current range, put down the " Hz%" to be Hz range and the frequency of the signal for the voltage and current are measured then. Press

the " Hz%" again to be the DUTY range and the DUTY CYCLE of the signal for the voltage and current are measured then. Press the " Hz%" again, meter will be back to the condition of the voltage and current measuring. The range of voltage and current are locked under this condition, which can be cancelled by rotating the transform switch or put down the "RANGE".



#### **4.5 RELATIVE TRANSFORM**



When measuring, put down the "REL.", meter will be transformed at relative measuring, initial display will show "000"; press the "REL" again, meter will recover the normal working condition. This can not be used under "OL" condition.

#### **4.6 BACK LIGHT**

If the light is too dark to make the reading difficult when measuring, you can press the "LIGHT" button to open the back light.

#### **NOTE:**

- LED is the main source of back light. Its working current is large, although the meter has the timer equipment (time is about 5 seconds and it will off automatically after 5 seconds); often use back light will shorten the battery life, you'd better not to use the back light so frequently if it's not necessary.
- When the battery voltage is less than 7V, it will show "". But if you use back light at the same time, maybe "" will come up even if the battery voltage is more than 7V, because

the working current is higher and the voltage will decline. (When “” shows, the accuracy of the measurement can not be assured.) You need not replace the battery. When you use normally (back light is not using), “” will not show up. You need replace it till “” show again.

#### **4.7 AUTO POWER OFF**

- If there's no any operation within fifteen minutes after power is on, meter will auto power off with five short sounds and a long sound in a minute.
- After auto power off, if stir the transform switch or put down any button of “HOLD”、 “FUNC”、 ”RANGE”、 ”Hz%”、 ”REL”, meter will recover the working condition.
- If presses the “FUNC” when power is on, auto power off disable.

#### **4.8 PREPARATION FOR MEASUREMENT**

4.8.1 Turn the transform switch. If the battery voltage is less than 7V, display will show “”, the battery should be changed at this time.

4.8.2 The “” besides the input lead shows that the input voltage or current should be less than specification on the sticker of the meter to protect the inner circuit from damaging.

4.8.3 Select a transform switch accordingly for the item to be measured.

4.8.4 When connection, first connect to the public testing line,

then to the electriferous testing line. When you'll remove it, you should remove the electriferous one.

#### 4.9 DC VOLTAGE MEASURING

 **WARNING**

**You can't input the voltage which more than 600V DC, it's possible to show higher voltage, but it's may destroy the inner circuit.**

**Pay attention not to get an electric shock when measuring high voltage.**

4.9.1 Connect the black test lead to the COM jack and the red test lead to the V jack.

4.9.2 Set the transform switch at the V range position.

4.9.3 Put down the "FUNC." to enter the DC measurement. Auto range or manual range can be transformed by putting the "RANGE".

4.9.4 Connect test leads across the source or load under measurement.

4.9.5 You can get reading from LCD. The polarity of the red lead connection will be indicated along with the voltage value.

**NOTE:**

- When only the figure 'OL' is displayed, it indicates overrange situation and the higher range has to be selected.

- When the value scale to be measured is unknown beforehand, set the range selector at the highest position.

#### 4.10 AC VOLTAGE MEASURING

 **WARNING**

**You can't input the voltage which more than 600V rms AC, it's possible to show higher voltage, but it's may destroy the inner circuit.**

**Pay attention not to get an electric shock when measuring high voltage.**

- 4.10.1 Connect the black test lead to the COM jack and the red test lead to the V jack.
- 4.10.2 Set the transform switch at the V range position.
- 4.10.3 Put down the "FUNC." to enter the AC measurement.  
Auto range or manual range can be transformed by putting the "RANGE".
- 4.10.4 Connect test leads across the source or load under measurement.
- 4.10.5 You can get reading from LCD.

**NOTE:**

- When only the figure 'OL' is displayed, it indicates overrange situation and the higher range has to be selected.
- When the value scale to be measured is unknown



beforehand, set the range selector at the highest position.

#### 4.11 DC CURRENT MEASURING



#### **WARNING**

**Shut down the power of the tested circuit, then connect the meter with the circuit for measurement.**

- 4.11.1 Connect the black test lead to the COM jack and the red test lead to the mA jack for a maximum of 400mA current. For a maximum of 10A, move the red lead to the 10A jack.
- 4.11.2 Set the transform switch at the desired A range position.
- 4.11.3 Put down the "FUNC." to enter the DC measurement. At mA range, auto range or manual range can be transformed by putting the "RANGE".
- 4.11.4 Connect test leads in series with the load under measurement.
- 4.11.5 You can get reading from LCD. The polarity of red connection will be indicated along with the voltage value.

#### **NOTE:**

- When only the figure 'OL' is displayed, it indicates overrange situation and the higher range has to be selected.
- When the value scale to be measured is unknown beforehand, set the range selector at the highest position.

- “” means the maximum current of mA socket is 400mA, the maximum current of 10A socket is 10A, over-current will destroy the fuse.

#### 4.12 AC CURRENT MEASURING

 **WARNING**

**Shut down the power of the tested circuit, then connect the meter with the circuit for measurement.**

- 4.12.1 Connect the black test lead to the COM jack and the red test lead to the mA jack for a maximum of 400mA current. For a maximum of 10A, move the red lead to the 10A jack.
- 4.12.2 Set the transform switch at the desired A range position.
- 4.12.3 Put down the "FUNC." to enter the AC measurement. At mA range, auto range or manual range can be transformed by putting the "RANGE".
- 4.12.4 Connect test leads in series with the load under measurement.
- 4.12.5 You can get reading from LCD.

**NOTE:**

- When only the figure 'OL' is displayed, it indicates overrange situation and the higher range has to be selected.
- When the value scale to be measured is unknown beforehand, set the range selector at the highest position.
- “” means the maximum current of mA socket is 400mA,



the maximum current of 10A socket is 10A, over-current will destroy the fuse.

#### 4.13 RESISTANCE MEASURING



#### WARNING

**When measuring in-circuit resistance, be sure the circuit under test has all power removed and that all capacitors have been discharged fully.**

- 4.13.1 Connect the black test lead to the COM jack and the red test lead to the  $\Omega$  jack.
- 4.13.2 Set the transform switch at the  $\Omega$    range position.
- 4.13.3 Put down the "FUNC." to enter the  $\Omega$  measurement. Auto range or manual range can be transformed by putting the "RANGE".
- 4.13.4 Connect test leads across the resistance under measurement.
- 4.13.5 You can get reading from LCD.

#### NOTE:

- When only the figure 'OL' is displayed, it indicates overrange situation and the higher range has to be selected.
- When the input is not connected, i.e. at open circuit, the figure '1' will be displayed for the overrange condition.
- For measuring resistance above  $1M\Omega$ , the meter may take a few seconds to get stable reading.

#### 4.14 CAPACITANCE MEASURING

##### **WARNING**

**To avoid electric shock, be sure the capacitors have been discharged fully before measuring the capacitance of a capacitor.**

4.14.1 Connect the black test lead to the COM jack and the red test lead to the  jack.

4.14.2 Set the transform switch at the  $\Omega \cdot \mu$   range position.

4.14.3 put down the "FUNC." transformed at  measurement.

4.14.4 Before connect test leads across two sides of the capacitor under measurement, be sure that the capacitor has been discharged fully.

4.14.5 You can get reading from LCD.

##### **NOTE:**

- It takes certain time (100 $\mu$ F range 30 seconds) to steady the reading when measuring high capacity.
- When measuring low capacity range under the open circuit, put down the "REL" to make the display show "000", then you might get reading from it.

#### 4.15 DIODE TESTING

4.15.1 Connect the black test lead to the COM jack and the red test lead to the  jack.

4.15.2 Set the transform switch at the  $\Omega$   range position.

4.15.3 Put down the "FUNC." transformed at  test.

4.15.4 Connect the red lead to the anode, the black lead to the cathode of the diode under testing.

4.15.5 You can get reading from LCD.

**NOTE:**

- The meter will show the approximate forward voltage drop of the diode.
- If the lead connection is reversed, only figure 'OL' will be displayed.

#### 4.16 CONTINUITY TESTING



**WARNING**

**When testing the circuit continuity, be sure that the power of the circuit has been shut down and all capacitors have been discharged fully.**

4.16.1 Connect the black test lead to the COM jack and the red test lead to the  $\Omega$  jack.

4.16.2 Set the transform switch at the  $\Omega$   range position.

4.16.3 put down the "FUNC." transformed at  continuity test.

4.16.4 Connect test leads across two points of the circuit under testing.

4.16.5 If continuity exists (i.e., resistance less than about

60Ω) , built-in buzzer will sound.

4.16.6 You can get reading from LCD.

**NOTE:**

- If the input open circuit (or the circuit resistance measured is higher than 400Ω), then the figure 'OL' will be displayed.

**4.17 FREQUENCY MEASURING**

4.17.1 Connect the black test lead to the COM jack and the red test lead to the Hz jack.

4.17.2 Set the transform switch at the Hz range position (or at the ACV range and the DCV range, put down the "Hz%" to transform to Hz measurement).

4.17.3 Connect test leads across the source or load under measurement.

4.17.4 You can get reading from LCD.

**4.18 DUTY CYCLE MEASURING**

4.18.1 Connect the black test lead to the COM jack and the red test lead to the Hz jack.

4.18.2 Set the transform switch at the Hz range position.

4.18.3 Put down the "Hz%" to enter the DUTY measurement (or set the transform switch at the ACV range and the DCV range, put down the "Hz%" to transform to DUTY measurement).

4.18.4 Connect test leads across the source or load under measurement.

4.18.5 You can get reading from LCD.

## 4.19 TEMPERATURE MEASURING

 **WARNING**

**To avoid electrical shock, do not connect the thermocouples with the electriferous circuit.**

- 4.19.1 Set the transform switch at the desired °C range position.
- 4.19.2 The 'LCD' display will show the current environment temperature.
- 4.19.3 When measuring the temperature with thermocouple, 'K' type probe for this meter can be used. Insert the black plug to the COM jack and the red one to the °C jack, touch the end of the temperature sensor to the area or surface of the object for measurement.
- 4.19.4 You can get reading from LCD.

**NOTE:**

- With better hermetization, the meter's temperature measured circuit and environment need a little longer time to reach heat balance, and then accurate reading can be gotten.

## 4.20 HUMIDITY MEASURING

 **WARNING**

**To avoid damage to the meter, input plug can not connect with any electric signal.**

4.20.1 Set the transform switch at the %RH range position.

4.20.2 The 'LCD' display will show the current environment humidity.

**NOTE:**

- When the tested environment humidity value changed. It need to a few minutes to get the stable "RH" reading.

**4.21 SOUND LEVEL (dB) MEASURING**



**WARNING**

**To avoid damage to the meter, input plug can not connect with any electric signal.**

4.21.1 Set the transform switch at the dB range position.

4.21.2 Move the sensor in front of the meter to the sound source in a horizontal position.

4.21.3 The 'LCD' display will show the current sound level (dB).

**NOTE:**

- The Fast response is suitable to measure sudden bursts and peak values from sound source.
- Strong wind (over 10m/sec.) striking the microphone call cause misreading for measurement in windy locations, a windscreen should be used in front of microphone.

**4.22 ILLUMINANCE MEASURING**



**WARNING**

**To avoid damage to the meter, input plug can not connect with any electric signal.**



4.22.1 Set the transform switch at the Lux or  $\times 10$ Lux range position.

4.22.2 Move the sensor in front of the meter to light source in a horizontal position.

4.22.3 The 'LCD' display will show the illuminance at the meter.

**NOTE:**

- When only the figure 'OL' is displayed, it indicates overrange situation and the higher range has to be selected.
- Spectral sensitivity characteristic: To the detector, the applied photo diode with filters makes the spectral sensitivity, characteristic almost meet C.I.E. (International Commission on Illumination) photopia curve V ( $\lambda$ ) as the following chart described.
- Recommended Illumination:

Locations	Lux
- Office	
Conference, Reception room.	200 ~ 750
Clerical work	700 ~ 1,500
Typewriting	1000 ~ 2,000
- Factory	
Packing , Entrance passage	150 ~ 300
Assembling line	300 ~ 750
Inspection work	750 ~ 1,500
Electronic parts assembly line	1,500 ~ 3,000
- Hotel	
Public, Cloakroom	100 ~ 200

Reception, Cashier	200 ~1,000
- Store	
Indoors Stairs, Corridor	150 ~ 200
Show window, Packing table	750 ~ 1,500
Shop window	1,500 ~ 3,000
- Hospital	
Sickroom, Warehouse	100 ~ 200
Medical Examination room	300 ~ 750
Operating room, Emergency room	750 ~ 1,500
- School	
Auditorium, Indoor Gymnasium	100 ~ 300
- Class room	200 ~ 750
Laboratory, Library	500 ~ 1,500

## 5. MAINTENANCE

### 5.1 BATTERY REPLACEMENT



#### WARNING

**Before attempting to remove the case, be sure that test leads have been disconnected from measurement circuit to avoid electric shock hazard.**

- 5.1.1 If the sign'  'appears on the LCD display, it indicates that the battery should be replaced.
- 5.1.2 Loosen the fixing screw of the case and remove it.  
(see the right photo)
- 5.1.3 Replace the exhausted battery with a new one.
- 5.1.4 Put the case as its origin.

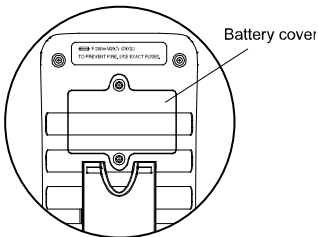

**NOTE:**

- The polarity of the battery can not be set inversely.

## 5.2 FUSE REPLACEMENT

**⚠ WARNING**

**To avoid electrical shock, remove test leads from measurement circuits before replacing the fuse.**

**For protection against fire, replace fuses only with specified ratings:**

**F 500mA/600V 10A/600V (quick acting).**

- 5.2.1 Fuse rarely need replacement and blow almost always as a result of the operator's error.
- 5.2.2 Loosen the fixing screw of the case and remove it.
- 5.2.3 Replace the blown fuse with ratings specified.
- 5.2.4 Put the case as its origin.

### 5.3 TEST LEADS REPLACEMENT

 **WARNING**

Full in compliance with safety standards can be guaranteed only if used with test leads supplied. If necessary, they must be replaced with the same model or same electric ratings. Electric ratings of the test leads: 600V 10A

You must be replaced the test leads if the lead is exposed.

### 6. ACCESSORIES

- |   |  |           |
|---|--|-----------|
| 1 | Test Leads: Electric Ratings 1000V 10A | one set   |
| 2 | Battery: 9V, NEDA 1604 or 6F22         | one piece |
| 3 | Thermocouple (K type)                  | one set   |
| 4 | Operating Manual                       | one piece |



# LUMEL

**LUMEL S.A.**

ul. Słubicka 4, 65-127 Zielona Góra, Poland  
tel.: +48 68 45 75 100, fax +48 68 45 75 508  
[www.lumel.com.pl](http://www.lumel.com.pl)

VA19-09